

AD 740662

*DD*

①

MISCELLANEOUS PAPER NO. 6-729

# PROJECT DUGOUT CONCRETE, GROUT, AND SHOTCRETE SUPPORT, AND DESIGN AND POSTSHOT EVALUATION OF STEM

by

K. L. Saucier

DISTRIBUTION STATEMENT A  
Approved for public release  
Distribution Unlimited



April 1965

D D C  
RECEIVED  
MAY 1 1972  
RECEIVED

Sponsored by

U. S. Army Engineer Nuclear Cratering Group

Conducted by

U. S. Army Engineer Waterways Experiment Station  
CORPS OF ENGINEERS

Vicksburg, Mississippi

NATIONAL TECHNICAL  
INFORMATION SERVICE

*17*

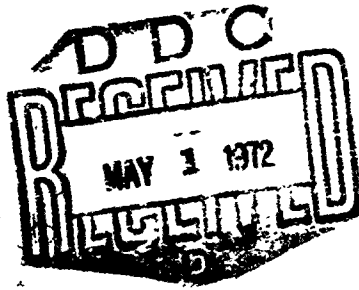

PNE 610F  
FINAL REPORT

**Plowshare**

civil, industrial and scientific uses for nuclear explosives

UNITED STATES ATOMIC ENERGY COMMISSION / PLOWSHARE PROGRAM

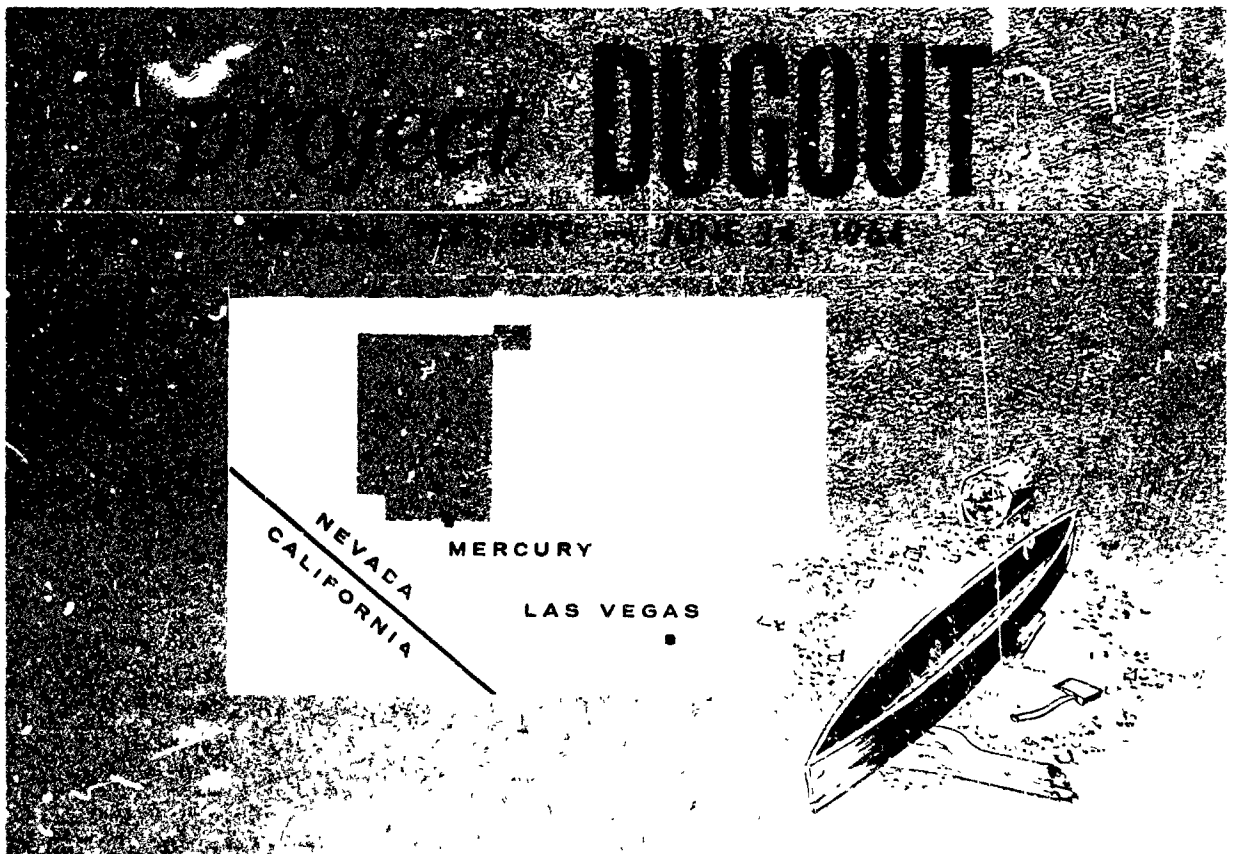

**Concrete, Grout, and Shotcrete Support,  
and Design and Postshot Evaluation of Stem**

KENNETH L. SAUCIER, Project Officer

#### LEGAL NOTICE

This document is a report of nuclear explosives studies for civil construction, conducted under the Civil Works General Investigations of the U. S. Army Corps of Engineers. The work is part of a nuclear excavation research program being carried out jointly with the Atomic Energy Commission. The results and findings of this report are those of the author(s) and not necessarily those of the AEC or Corps of Engineers. Accordingly, reference to this materials must credit the author(s). This report is the property of the Department of the Army and, as such, may be reclassified or withdrawn from circulation as appropriate by the Corps of Engineers.

PROJECT DUGOUT

CONCRETE, GROUT, AND SHOTCRETE SUPPORT, AND DESIGN AND POSTSHOT EVALUATION

OF STEM

PNE 610F

Kenneth L. Saucier, Project Officer

U. S. Army Engineer Waterways

Experiment Station

Corps of Engineers

Vicksburg, Mississippi

December 1964

## ABSTRACT

Project DUGOUT consisted of the simultaneous detonation of five, 20-ton, chemical, row-charge explosives in hard, dry rock, at a scaled depth of burst of 185 ft/kt <sup>±/3.4</sup>. → The primary purpose of the project was to increase the knowledge of row cratering dimensions in hard, dry rock. ~~This~~ <sup>The</sup> report describes the following work performed for the project by personnel of the U. S. Army Engineer Waterways Experiment Station: (1) the design and placement of grout mixtures used in grouting satellite holes surrounding the anticipated trench, (2) the design and supervision of the placement of a shotcrete mixture used in lining the walls of each of the shot cavities, (3) the design and supervision of the placement of a concrete mixture used in stemming the access holes to each of the shot cavities, (4) the design of the stem configuration for each of the five shot holes, and (5) postshot evaluation of stem design and survey of stem ejecta. ( )

The stems designed for the project appear to have acted effectively. Apparently the lower part of the stems, from the reinforced concrete keys down, failed in compression and shear with the steel taking predominant shear stresses. Tensile spalling and bond failure were evident in the upper stem portions; however, there was evidence of conjugate concrete-basalt action in this area.

## FOREWORD

The work described in this report was authorized by Intra-Army Order for Reimbursable Work or Service, No. NCG1AO 7-64, dated 21 April 1964, from the U. S. Army Engineer Nuclear Cratering Group, Livermore, California, to the U. S. Army Engineer Waterways Experiment Station (WES).

The laboratory tests and design study were conducted at the WES under the supervision of Messrs. Thomas B. Kennedy, Chief, Concrete Division; James M. Polatty; William O. Tynes; and Kenneth L. Saucier, Project Officer. The field work was performed at the U. S. Atomic Energy Commission Nevada Test Site in May-June 1964. Mr. J. E. McDonald made the postshot stemming evaluation. Mr. Saucier prepared this report.

Col. Alex G. Sutton, Jr., CE, was Director of the WES during the investigation and the preparation and publication of this report. Mr. J. B. Tiffany was Technical Director.

## CONTENTS

ABSTRACT . . . . .	2
FOREWORD . . . . .	3
CHAPTER 1 INTRODUCTION . . . . .	5
1.1 Purpose and Background . . . . .	5
1.2 The Test Site . . . . .	6
1.3 Scope . . . . .	7
CHAPTER 2 STEM DESIGN . . . . .	10
2.1 Design Objective . . . . .	10
2.2 Design Criteria . . . . .	10
2.3 Concrete Mixture Data . . . . .	12
2.4 Tests, Results, and Design Approach . . . . .	13
2.4.1 Tests . . . . .	13
2.4.2 Results . . . . .	14
2.4.3 Design Approach . . . . .	15
2.5 Design Calculations . . . . .	17
2.5.1 Holes U18g and U18h . . . . .	17
2.5.2 Hole U18i . . . . .	18
2.5.3 Holes U18j and U18k . . . . .	19
CHAPTER 3 CONCRETE, SHOTCRETE, AND GROUT SUPPORT . . . . .	25
3.1 Concrete . . . . .	25
3.2 Shotcrete . . . . .	27
3.3 Grout . . . . .	29
CHAPTER 4 STEM EVALUATION . . . . .	33
APPENDIX A: POSTSHOT STEMMING EVALUATION . . . . .	37
TABLES	
3.1 Shotcrete and Grout Materials and Mixture Proportions . . . . .	31
FIGURES	
1.1 Centerline section of typical charge emplacement . . . . .	9
2.1 Frames in which basalt specimens were grouted to stabilize the specimens during drilling of 3-inch-diameter hole in center of each specimen . . . . .	15
2.2 Basalt punch-out test specimen with concrete filler in place . . . . .	15
2.3 Punch-out testing apparatus . . . . .	16
2.4 Loading apparatus for punch-out tests with specimen in place . . . . .	17
2.5 Mohr-circle analysis for shear strength determination . . . . .	16
3.1 Types of nails used for postshot identification of ejecta from different holes . . . . .	32
A1 Layout of ejecta location positions . . . . .	46

## PROJECT DUGOUT

### CONCRETE, GROUT, AND SHOTCRETE SUPPORT, AND DESIGN AND POSTSHOT

### EVALUATION OF STEM

#### CHAPTER 1

#### INTRODUCTION

##### 1.1 PURPOSE AND BACKGROUND

Project DUGOUT, a chemical explosive, row-charge cratering experiment in hard rock consisted of one row of five 20-ton charges detonated simultaneously on Buckboard Mesa in Area 18 of the Nevada Test Site (NTS). The explosive was liquid nitromethane ( $\text{CH}_3\text{NO}_2$ ), a chemical used in previous experiments and found to have cratering characteristics similar to TNT and superior handling and safety characteristics. The main purpose of the project was to provide row-charge cratering experience in a hard rock medium. Preshot and postshot exploratory programs were undertaken to provide data for scientific and engineering studies under the joint Atomic Energy Commission-Corps of Engineers nuclear excavation research program.

As a result of considerable experimental work concerning row craters created by high explosives (HE) in alluvial material, the following general conclusions have been reached concerning effects of charge spacing and depth of burial in such explosions:

1. Detonations with charges spaced approximately equal to a single-charge-crater radius result in smooth ditches with average dimensions from 10 to 20 percent greater than single-charge-crater dimensions for the same depth of burst (Dob). A 25 percent greater spacing gives a less



regular ditch with average dimensions approximately equal to the corresponding single-charge-crater dimensions.

2. Row charges result in craters with no appreciable lip or up-thrust material at the ends of the row and with lips along the sides which are 50 to 100 percent higher than those of single-charge craters having the same depth.

3. Ground shock and airblast signals recorded close to the detonation are consistent with superposition of the signals from the individual charges.

There have been no comparable experiments with multiple charges in hard rock. Investigation of the effect of a rock medium on the foregoing conclusions was needed because almost all practical applications of large-scale cratering will be in rock. Previous experiments in the basalt on Buckboard Mesa have indicated that charges at least as large as 20 tons are needed to give results which can be extrapolated to larger yields.

In addition, it should be noted that the Pre-SCHOONER results together with the results from the DUGOUT experiment will greatly reduce present uncertainties concerning predicted crater dimensions for row charges in basalt.

## 1.2 THE TEST SITE

The general site selected for Project DUGOUT was the Buckboard Mesa in Area 18 of the NTS. This site was selected for several reasons:

1. The previous chemical explosive cratering experiments in hard, dry rock (Project BUCKBOARD and Project Pre-SCHOONER) were done at this site.

2. The only nuclear cratering experience in hard, dry rock (DANNY BOY) was at this site.

3. The NIS offers fully developed and functioning operational facilities for chemical and nuclear explosive detonations.

4. Access to Buckboard Mesa is convenient.

5. Extensive prior surface and subsurface exploration on Buckboard Mesa indicated that a suitable site for Project DUGOUT was available.

Personnel of the U. S. Army Engineer Waterways Experiment Station (WES) studied all existing geologic data on Buckboard Mesa, and drilled additional exploratory holes in order to select the ground zero locations for Project DUGOUT.

### 1.3 SCOPE

Each charge in the event consisted of 40,000 pounds of the liquid explosive nitromethane ( $\text{CH}_3\text{NO}_2$ ) contained in a mined spherical cavity approximately 10.5 feet in diameter. Thirty-six-inch-diameter access holes were drilled to a depth of 64 feet. The center of the charge was 59 feet below the surface at a scaled Dob of  $185 \text{ ft/kt}^{1/3.4}$ . The cavity was constructed and then surface-finished and made impermeable by the application of pneumatically applied mortar known as gunite, or shotcrete. As an additional precaution against loss of explosive, the shotcrete lining was painted with a liquid rubber compound. The access holes were stemmed with concrete and reinforced concrete keys were designed to allow the stem to match the physical properties of the basalt as closely as

possible. All construction was completed before the explosive was placed in the cavity. Aluminum fill and vent lines were installed through the stem and into the cavity to permit gravity filling. Each 20-ton charge was center-detonated by means of a 5-pound booster. Figure 1.1 shows the centerline section of a typical charge emplacement.

The WES Concrete Division contracted to provide the following services:

1. Laboratory design of the mixture used to line the shot cavities and technical supervision and inspection of the shotcreting operation.
2. Personnel and equipment to place colored grout and serrated tapes in NX-size satellite holes drilled at each site to assist in the postshot investigation of the craters.
3. Design of the five stem configurations to include keys and reinforcing steel as necessary.
4. Technical supervision and inspection of the stemming operations.
5. Postshot evaluation of stem design and survey of stem ejecta.

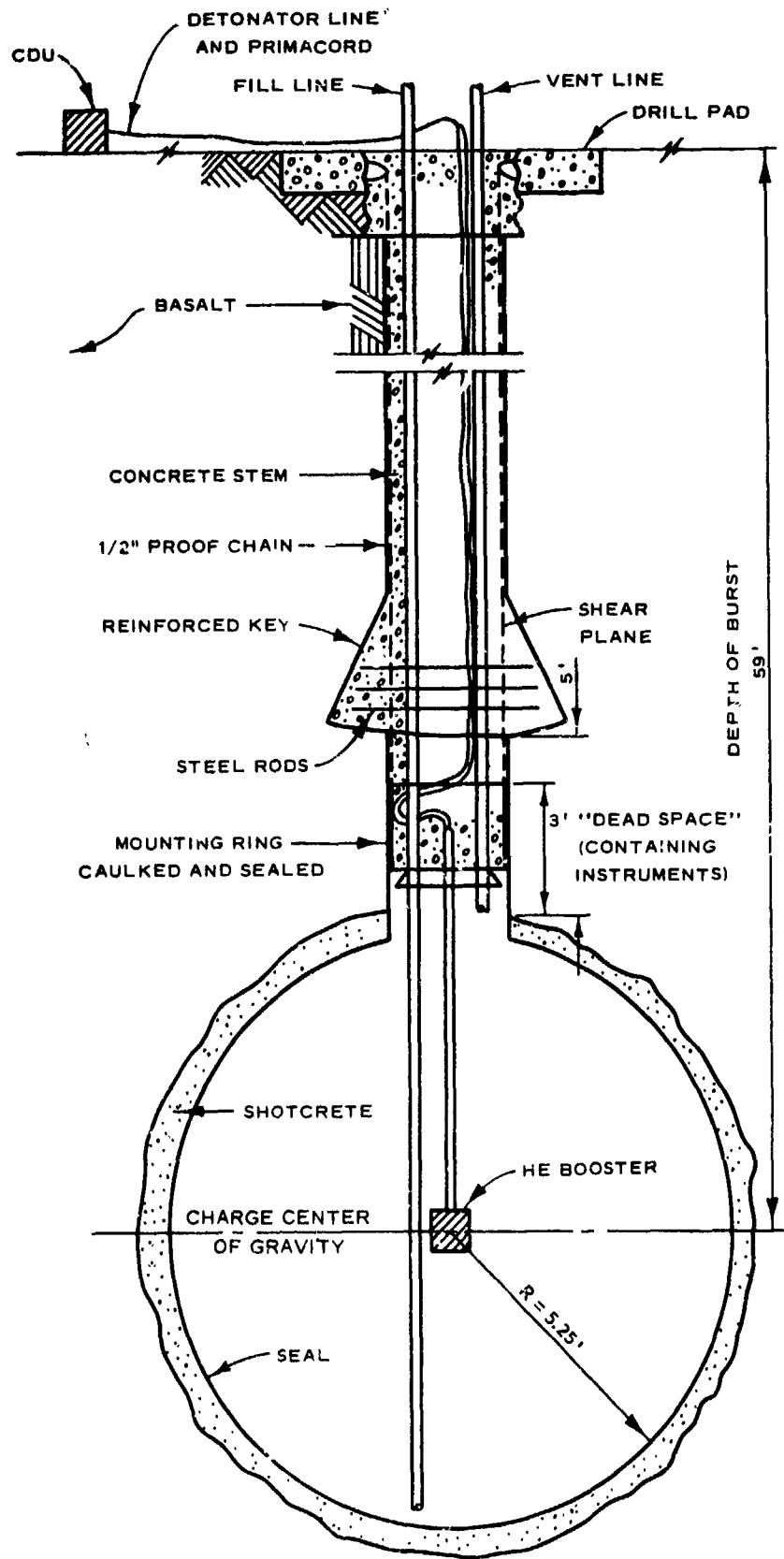

Figure 1.1 Centerline section of typical charge emplacement.

## CHAPTER 2

### STEM DESIGN

#### 2.1 DESIGN OBJECTIVE

In order to prevent the energy of each explosion from venting prematurely through the access hole, it was necessary that the access hole be adequately stemmed with a material which would react in the same manner as the in situ medium when subjected to the forces of the detonation. The objective of the stem design study was to develop a stem which would replace the in situ material so as to permit a crater to develop as if an access hole had not been drilled. A reinforced concrete stem, utilizing shear keys if necessary, was considered to be the most practical design.

#### 2.2 DESIGN CRITERIA

The stemming material was a concrete mixture designed to match as closely as possible the structural properties of the in situ basalt. The structural properties considered to be the most important in this regard were tensile strength, shear strength, and compressive strength. Two other properties, density and pulse velocity, were closely matched by the concrete, but these are secondary properties with respect to the stem design. Considering the structural properties, it is obvious that the continuous medium would not react in the same manner as the laboratory specimens. The standard tests for tensile, shear, and compressive strengths are unconfined tests on specimens extracted from the continuous medium. In reality, the application of unconfined test values in lieu

of confined test values is only an approximation.

A further limitation on the design of a proper stem was a lack of dynamic-shear design criteria and dynamic-testing facilities of sufficient capacity. The values determined in the laboratory in this study were static values, and since the relation of dynamic to static bond-shear is not known, the static values are used. However, these values probably are conservative since the dynamic design values that are known are usually higher than corresponding static values.

The basic criterion was to design the total bond-shear resistance of the concrete-basalt interface to be at least equal to the total unconfined static shear resistance of the basalt by using bond-shear strength of concrete to basalt and shear keys as necessary. The resistance capacity of the stem was considered separately in each stratum of the basalt. Shear keys were used whenever the bond-shear value between the stemming material and the particular stratum of basalt was less than the static unconfined shear strength of that stratum. The keys were designed from a dynamic approach since literature on this particular subject is available.

Other pertinent criteria were as follows:

1. The 21-day strength of the concrete design proportioned at WES and cured under optimum conditions in the laboratory was reduced 15 percent for design calculations because of unknown field curing conditions and the uncertainty of the detonation schedule.

2. For ease of mining, the keys were of the "dovetail" type, designed shoulder down, with a convenient ratio of key shoulder size to key height.

3. There was no requirement for vertical steel in this design approach.

4. Solid basalt was considered to be that point where the vesicles decreased to approximately 10 to 15 percent of the mass.

### 2.3 CONCRETE MIXTURE DATA

The concrete mixture used in the stemming was proportioned to have a cement factor of 7.5 bags/yd<sup>3</sup>, a water-cement ratio of 0.48 by weight, and a slump of 3-1/2 ± 1/2 inches. The mixture proportions were:

Material	Batch Data Based on 1 Bag of Cement	
	Solid Volume	Saturated Surface Dry Weight
	feet <sup>3</sup>	pounds
Type III portland cement	0.479	94.00
Metallic aggregate	0.085	30.00
NTS alluvium sand	0.417	67.25
Magnetite sand	0.417	117.69
NTS alluvium coarse aggregate	1.421	237.25
Water	0.689	42.92
Concrete coloring	--	5.00
Water-reducing admixture (lignin base)	--	0.25

At each quarter height of the stem, the concrete color was changed to aid in the postshot study of crater ejecta. The metallic aggregate, a commercial product consisting primarily of iron filings, was used to increase the density and prevent shrinkage of the mixture. The coarse aggregate was nominal 1-1/2-inch maximum size NTS alluvium. The grading of each of the aggregates except the metallic was as follows:

Sieve Size	Cumulative Percent Passing		
	Coarse Aggregate	Magnetite Fine Aggregate	Alluvium Fine Aggregate
2-inch	100	--	--
1-1/2-inch	98	--	--
1-inch	60	--	--
3/4-inch	45	--	--
1/2-inch	32	--	--
3/8-inch	23	--	--
No. 4	2	100	100
No. 8	--	100	92
No. 16	--	99	54
No. 30	--	80	29
No. 50	--	30	13
No. 100	--	0	3

The specific gravities of the coarse, magnetite fine, and alluvium fine aggregates were 2.68, 4.90, and 2.59, respectively; the percentages of absorption were 0.6, 0.5, and 0.2 for the same respective aggregates.

## 2.4 TESTS, RESULTS, AND DESIGN APPROACH

2.4.1 Tests. Bond-shear, tensile, and compressive strength tests were conducted on the concrete for comparison with the two different types of basalt (i.e. vesicular and solid) at the test site. A description of these tests follows.

### 1. Punch-Out Tests

The purpose of the punch-out tests was to simulate, on a small scale, the effect of the blast on the concrete stem. Six-inch-diameter cores obtained from the test site were sawed into lengths ranging from 3 to 12 inches. These specimens were then grouted into a square form (Figure 2.1) to furnish stability during the drilling of a 3-inch-diameter



hole through the center of each specimen. The holes in the specimens were then filled to different depths with the stem concrete mixture which was allowed to cure for 14 days. In each specimen, the top end of the concrete "plug" was capped with a high-strength gypsum compound. A typical specimen is shown in Figure 2.2. Each specimen was then placed in the punch-out stabilizing frame (Figure 2.3a) and cemented in and to the frame with the high-strength gypsum plaster to effect a condition of biaxial confinement. The frame was placed in a 440,000-pound-capacity testing machine, a 3-inch-diameter steel piston (Figure 2.3b) was placed on the capped concrete plug, and the entire assembly was carefully leveled to avoid eccentric loading. The piston was loaded (Figure 2.4) until the bond between the concrete and basalt failed.

## 2. Conventional Tests

Static tensile-splitting strength and compressive strength tests were performed on the basalt and stemming concrete to obtain data for use in the design analysis and to compute shear strength. The shear values used in the calculations were obtained from the static compressive and tensile strength values plotted on a Mohr's circle. The shear strength analysis is presented in Figure 2.5.<sup>1</sup>

2.4.2 Results. The results of the various tests are given on the following page.

---

<sup>1</sup>This analysis was obtained from "The shear strength of rocks," by R. G. Wuerker, Mining Engineering, vol. 11 (October 1959) pp 1022-1026.

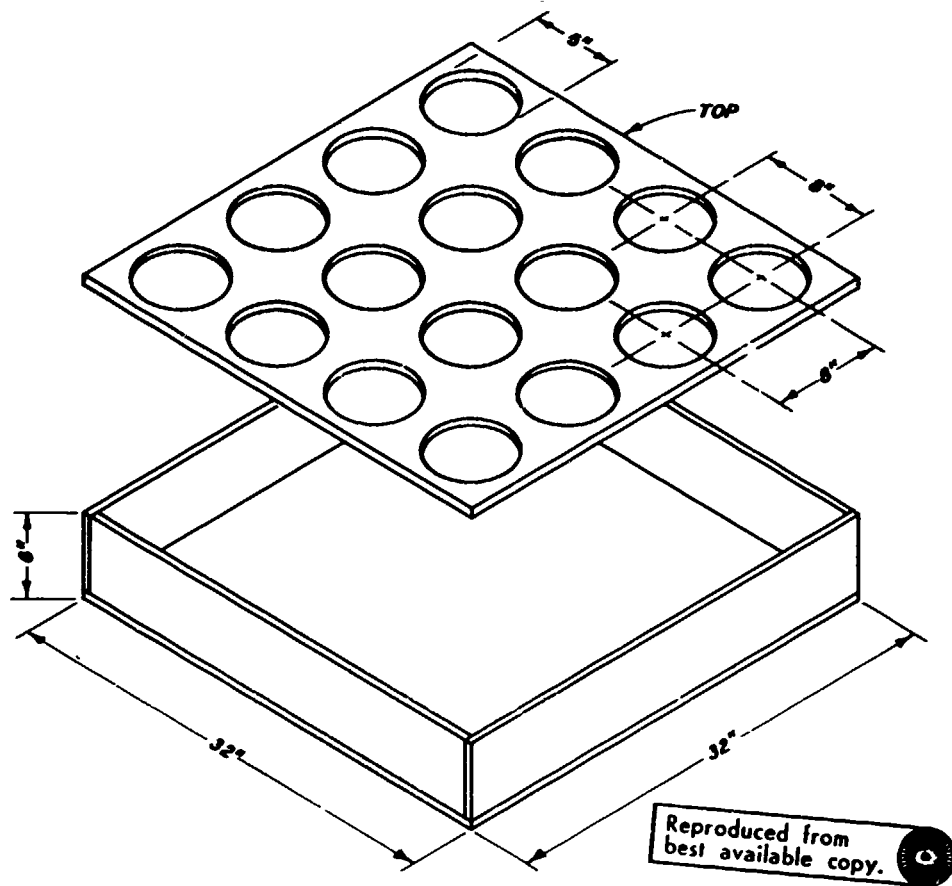

Figure 2.1 Frames in which basalt specimens were grouted to stabilize the specimens during drilling of 3-inch-diameter hole in center of each specimen.



a. Top view showing high-strength gypsum plaster cap on concrete filler.

b. Side view (3-5/16 corresponds to the height in inches of concrete filler from the base to the cap).

Figure 2.2 Basalt punch-out test specimen with concrete filler in place.

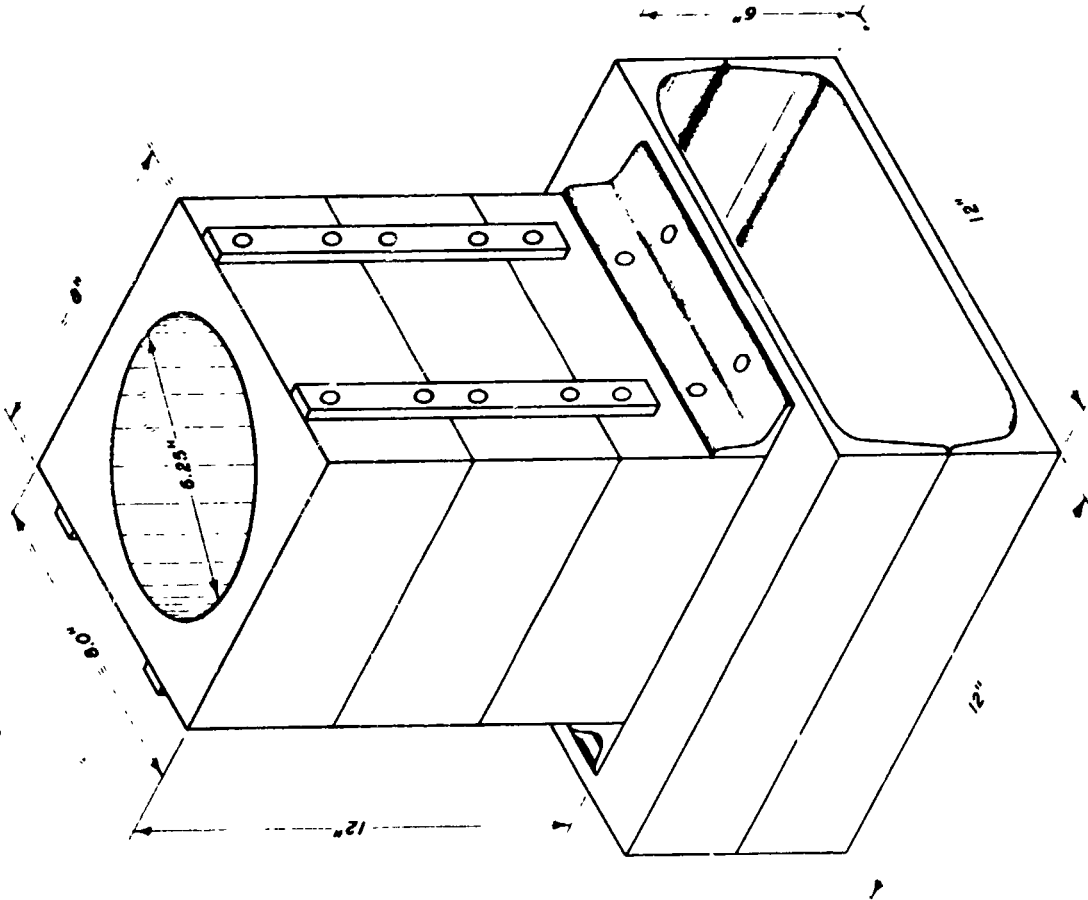

a. Punch-out testing frame.

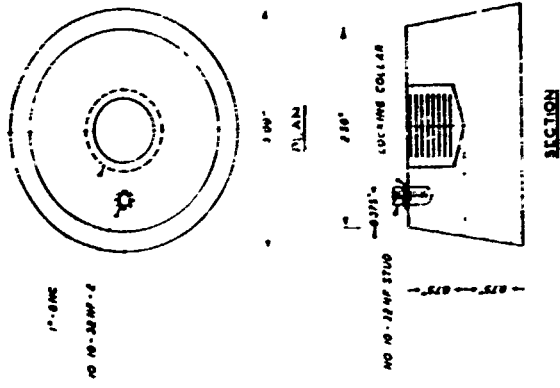

b. Punch-out piston.

Figure 2.3 Punch-out testing apparatus.

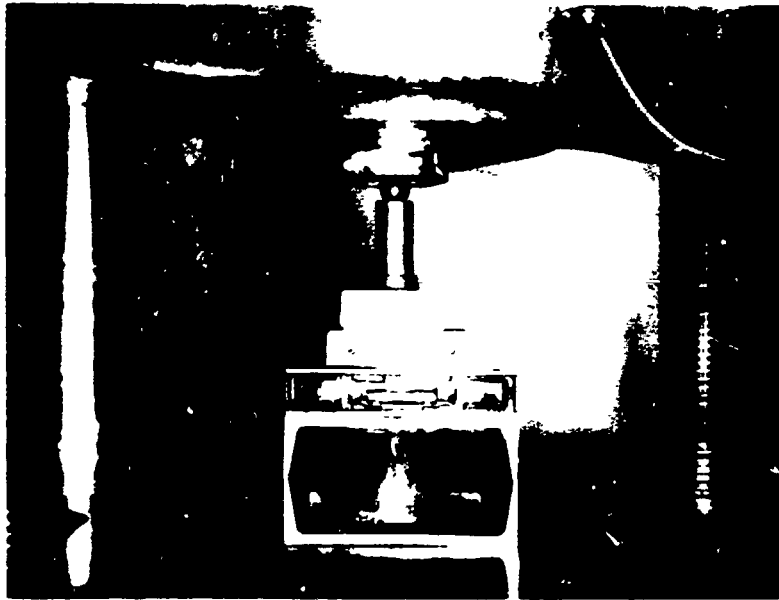

Reproduced from  
best available copy.

Figure 2.4 Loading apparatus for punch-out tests with specimen in place.

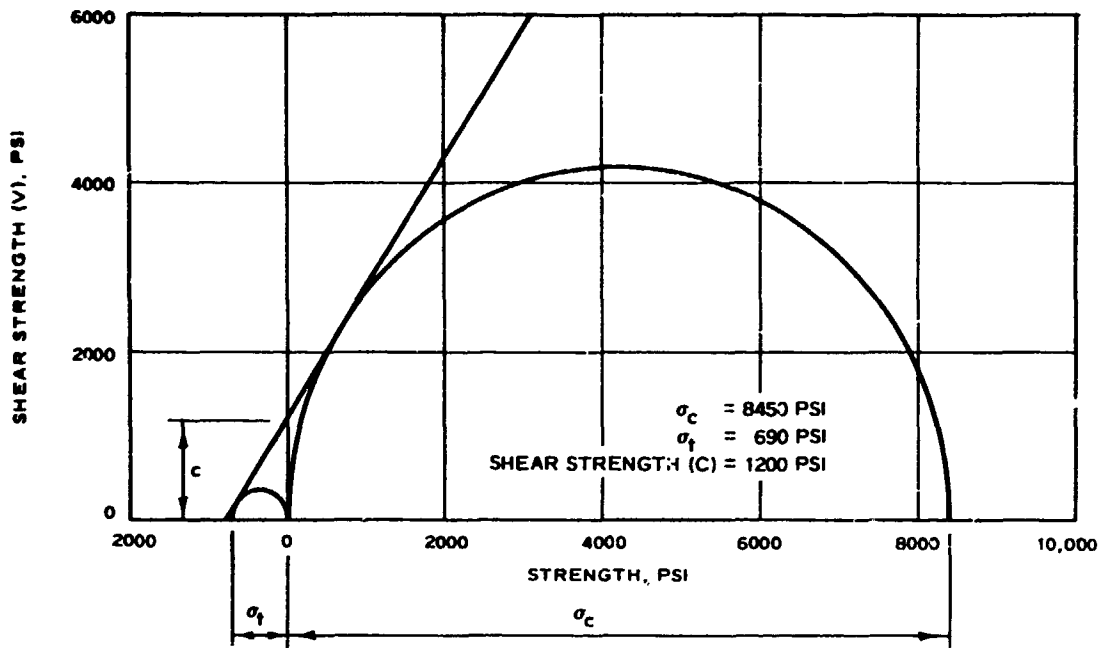

a. VESICULAR BASALT

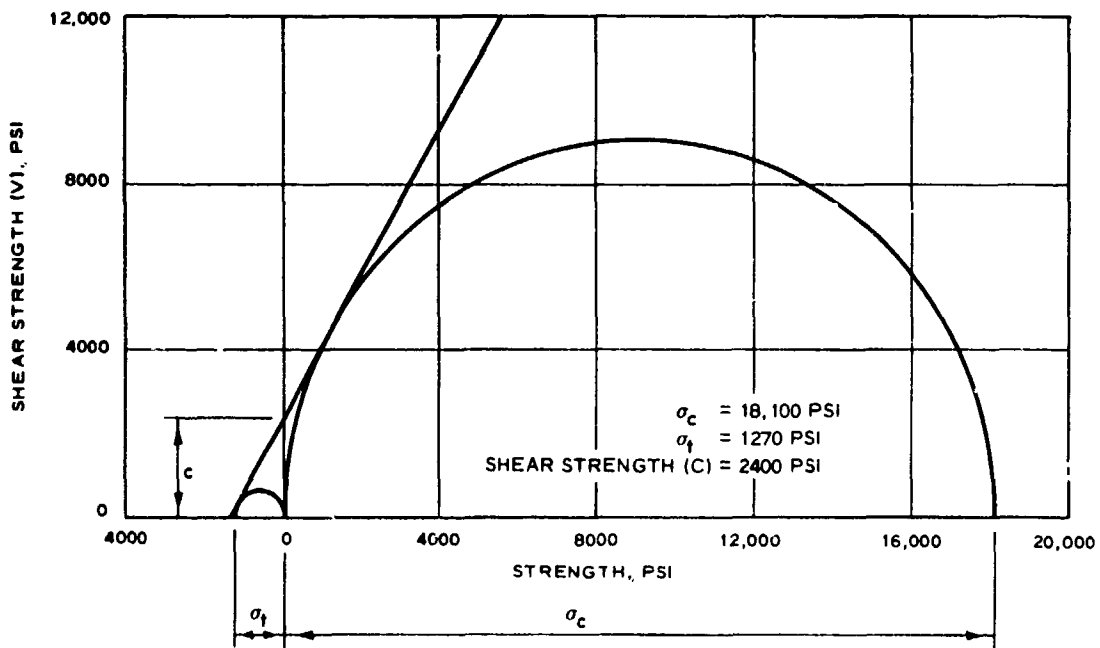

b. SOLID BASALT

Figure 2.5 Mohr-circle analysis for shear strength determination.

Tests	Material	Average Strength
		psi
Punch-out (Bond-shear)	Basalt - Solid	1,180
	Vesicular	1,560
Static compressive strength, $\sigma_c$ (Unconfined)	Basalt - Solid	18,100
	Vesicular	8,450
	Concrete	7,840
Static tensile-splitting strength, $\sigma_t$ (Unconfined)	Basalt - Solid	1,270
	Vesicular	690
	Concrete	780
Static shear strength, C (Computed) <sup>2</sup>	Basalt - Solid	2,400
	Vesicular	1,200

Note: The concrete in the punch-out tests had been cured for 14 days.

The concrete in the other tests had been cured for 21 days.

2.4.3 Design Approach. The initial assumptions indicated that to prevent the stem from blowing out ahead of the basalt at the time of blast, there must be at least as much shearing resistance between the stem and the in situ basalt as there is in the basalt. It is evident from the punch-out-test results that the bond-shear value is greater than the shear strength for vesicular basalt, and less for solid basalt. This is natural as the solid basalt would be expected to produce less bond than the more porous vesicular basalt. The apparent shear plane is at the interface of the concrete and basalt except in the key where it is assumed to be vertical (see Figure 1.1). Since the key will be designed to fail with the basalt, ultimate design procedures apply. Thus, the reinforcing

<sup>2</sup> Ibid, page 14.

steel and the concrete will act together to achieve ultimate strength.<sup>3</sup>

The design procedure for matching the shear resistance in the solid basalt region is as follows:

1. Compute the shear resistance of the solid basalt mass based on the circumferential surface area of the access hole.

2. Assume a key size and compute the available concrete bond-shear resistance of the access hole circumferential area less the key height and the 3-foot "dead space" above the sphere which contains instrumentation.

3. Compute the shear resistance required to match the basalt (computation 1 minus computation 2).

4. Compute the dynamic shear resistance of the shear key using the appropriate dimensions and the following expression<sup>4</sup> for one unreinforced key:

$$\tau = 0.64 f'_c$$

where

$\tau$  = shear resistance, psi

$f'_c$  = compressive strength of concrete, psi

5. Compute additional shear strength supplied by using reinforcing steel bars and applicable design recommendations for shear strength of steel (21,000 psi is taken from page 9 of Norris et al.<sup>3</sup>).

---

<sup>3</sup> C. H. Norris and others, Structural Design for Dynamic Loads, McGraw-Hill Book Co., Inc. (New York, N. Y., 1959).

<sup>4</sup> Indravadan Shah, Dynamic Shear Strength of Concrete Key, Massachusetts Institute of Technology, R-63-5 (DASA 1059) (January 1965).

6. Compute total force available (computation 4 plus computation 5) and check against shear resistance required to match the basalt (computation 3).

7. Compute the required length of steel bars to fully develop the dynamic bond on each side of the shearing plane. Norris et al. (page 46) recommended an ultimate dynamic bond stress of  $0.15 f'_c$ .

## 2.5 DESIGN CALCULATIONS

2.5.1 Holes U18g and U18h. Field logs indicated 10 to 15 percent vesicles at approximately the 42-foot depth. A key was required to match the shear strength for 12 feet of solid basalt and the following design calculations were used:

1. Shear resistance of solid basalt (interface area) = hole circumference (in.) x shear strength (psi) x height of solid basalt region (in.) =  $113 \times 2400 \times 144 = 3.90 \times 10^7$  lb.

2. To obtain available concrete bond-shear resistance, a 5-foot-high key was assumed. Four feet of circumferential area were available for bond; i.e. 2 feet above the key and 2 feet below. Hole circumference (in.) x bond-shear (psi) x height of solid basalt region (in.) =  $113 \times 1280 \times 48 = 0.64 \times 10^7$  lb.

3. A key was needed to provide the additional  $3.26 \times 10^7$  lb ( $3.90 \times 10^7 - 0.64 \times 10^7$ ) resistance.

4. Unit shear resistance ( $\tau$ ) of a key =  $0.64 f'_c \times 0.85$ .<sup>5</sup>

---

<sup>5</sup>The strength of the laboratory-proportioned concrete was reduced 15 percent for design calculations because of the uncertainty of field curing conditions.



Hole circumference (in.)  $\times$  compressive strength of concrete (psi)  $\times$   
height of key (in.) =  $113 \times (0.64 \times 0.85 \times 7840) \times 60 = 2.89 \times 10^7$  lb.

5. Ten No. 10 reinforcing steel bars per foot were added to provide additional strength. A double area of  $2 \times 1.27 \text{ in.}^2 = 2.54 \text{ in.}^2$ . The dynamic shear strength of steel is taken as 21,000 psi. The doubled diameter (in.)  $\times$  shear strength of steel (psi)  $\times$  number of bars per foot  $\times$  height of key (ft) =  $2.54 \times 21,000 \times 10 \times 5 = 0.27 \times 10^7$  lb.

6. The available force (design calculation 4 + calculation 5) =  $3.16 \times 10^7$  lb.

7. The following procedure was used to determine the required length of steel in the keyway to develop sufficient bond:

(1)  $f'_c$  (psi) =  $0.85 \times 7840 = 6660$ .

(2) Bond strength (psi) =  $0.15 \times 6660 = 990$ .

(3) Circumference of No. 10 bar (in.) = 3.99.

(4) Bond strength per inch of bar length (lb) =  
 $3.99 \times 990 = 3950$ .

(5) Force developed in each bar (lb) =  $21,000 \times 1.27 = 26,670$ .

(6) Length of steel bars required in the keyway to develop sufficient bond (in.) =  $\frac{26,670}{3950} = 6.75$ .

A 5-foot-high key with a lip depth of 2.5 feet and ten No. 10 reinforcing steel bars (7.0-inch minimum bonded length) per foot of key height was recommended. Although the recommended stem was underdesigned approximately 3 percent, it was considered satisfactory.

2.5.2 Hole U18i. The field log indicated 10 to 15 percent vesicles at approximately the 44-foot depth. A key was required to match the

shear strength of 10 feet of solid basalt and the following design calculations were used:

1. Shear resistance of solid basalt (lb) =  $3.25 \times 10^7$ .
2. To obtain available concrete bond-shear resistance, a 5-foot-high key was assumed. Two feet of circumferential area (below key) were available for bond. Available bond strength (lb) =  $0.32 \times 10^7$ .
3. A key was needed to provide the additional  $2.93 \times 10^7$  lb shear resistance.
4. The unit shear resistance of a 5-foot-high key was  $2.89 \times 10^7$  lb.
5. The reinforcing steel bars provided  $0.27 \times 10^7$  lb of additional strength.
6. The available force (lb) =  $3.16 \times 10^7$ .
7. Length of steel bars required in the keyway to develop bond was 7.0 inches (minimum).

A 5-foot-high key with a lip depth of 2.5 feet and ten No. 10 reinforcing steel bars (7.0-inch minimum bonded length) per foot of key height was recommended. The stem was oversized approximately 8 percent and therefore was considered satisfactory.

2.5.3 Holes U18j and U18k. Field logs indicated 10 to 15 percent vesicles at approximately the 38-foot depth. A key was required to match the shear strength of 16 feet of solid basalt and the following design calculations were used:

1. Shear resistance of solid basalt (lb) =  $5.20 \times 10^7$ .
2. To obtain available concrete bond-shear resistance, a 6-foot-high key was assumed. Seven feet of area were available for bond;

i.e. 5 feet above the key and 2 feet below Available bond strength

$$(lb) = 1.12 \times 10^7.$$

3. A key was needed to provide the additional  $4.08 \times 10^7$  lb shear resistance.

4. The unit shear resistance of a 6-foot-high key was  $3.47 \times 10^7$  lb.

5. The reinforcing steel bars provided  $0.32 \times 10^7$  lb of additional strength.

6. The available force (lb) =  $3.79 \times 10^7$ .

7. Length of steel bars required in keyway to develop sufficient bond (in.) = 7.0 (minimum).

A 6-foot-high key with a lip depth of 3 feet and ten No. 10 reinforcing steel bars (7.0-inch minimum bonded length) per foot of key height was recommended. Although the recommended stem was underdesigned approximately 6 percent, the design was considered satisfactory.

## CHAPTER 3

### CONCRETE, SHOTCRETE, AND GROUT SUPPORT

#### 3.1 CONCRETE

The following procedure was utilized in the placement of the stems:

1. The required reinforcing steel was placed in the keys and tied in place.

2. An initial lift of approximately 5 feet of concrete was mixed, placed as support for the remainder of the stem, and allowed to set for 24 hours.

3. Succeeding lifts of the concrete stem were mixed and placed.

Four cubic yards of concrete were mixed per batch in 6-cubic-yard transit truck mixers and placed in each hole by means of a tremie to avoid undesirable segregating of aggregates. The metallic aggregate was not used in the concrete of the first lift because of possible metallic contamination in the chemical explosive charge in the cavity. Consolidation was effected by lowering a man into the keyways who used an electric vibrator to consolidate the concrete as it was placed through the tremie. When the concrete level reached the keyway, the man was hoisted out of the keyway, and consolidation was effected by lowering the vibrator to the concrete with a rope. To aid in postshot identification of recovered pieces of stem, a different type of nail (Figure 3.1) was incorporated in the concrete of each hole and each lift of concrete was color-coded as indicated in the following tabulation:

Hole No.	Type of Nail	Depths of Colored Concrete, feet			
		Green	Terra Cotta	Brown	Yellow
U18g	8 D common	0 to 14	14 to 33	33 to 46	46 to 54
U18h	1-in. galvanized fence staple	0 to 14	14 to 33	33 to 47	47 to 54
U18i	1-1/4-blued plaster board nail, 3/8-in. head	0 to 18	18 to 37	37 to 47	47 to 54
U18j	16 D smoothbox	0 to 23	23 to 41	41 to 47	47 to 54
U18k	7/8-barbed roofing nail, 7/16-in. head	0 to 25	25 to 43	43 to 48	48 to 54

Hardened concrete tests were made on cast cylindrical specimens taken from representative batches from each stem-placing operation to check the consistency, quality, density, and strength of the concrete. Some specimens were tested at the site at intermediate ages to give an indication of the strength gain with respect to age of the concrete. Results are given below:

Lift No. (All Holes)	Density, 21 Days	Ultrasonic Pulse Velocity, 21 Days	Compressive Strength at Days Age		
			3*	6 or 7*	21
	pcf	ft/sec		psi	
1	160.73	13,970	3490	4120	5970
2	163.85	14,290	--	4630	6360
3	166.36	14,660	--	4940	7130
4	165.10	14,170	--	4860	6740
Average	164.16	14,270	3490	4640	6550

\* Specimens tested in field; all other results from laboratory tests.

The test results indicate that quality concrete was obtained on the job, as all design requirements (density, approximately 165 pcf; pulse velocity, 14,000 ft/sec; compressive strength, 6500 psi) were met.

### 3.2 SHOTCRETE

In order to obtain a relatively smooth surface on the walls of the shot cavities, it was decided to apply a mortar coating as necessary over the rough mined surfaces. The wet-process shotcrete procedure features pneumatically premixed mortar with the water-cement ratio controlled at the mixer. In the method used, the premixed material was metered into a high-velocity airstream and continuously fed to the nozzle at high velocity. Air pressure was also provided at the nozzle to give an additional boost to the material; however, the nozzle booster is not necessarily required, due to the high-velocity airstream conveying the materials. When the slump of the mixture was decreased to less than 3 inches, stoppages occurred within the delivery hose. When the slump of the mixture was increased beyond 4 inches, the mixture did not adhere satisfactorily to the walls of the cavity. A layer of wire mesh was installed around the periphery of the cavity to help hold the mixture when it was applied and to provide tensile strength. The shotcrete was mixed in a conventional 16-cubic-foot concrete mixer. The mixture was applied in layers of 1 to 2 inches thick at rates of 1 to 2 ft<sup>3</sup>/min. Each layer was allowed to reach its initial set, and then another layer was applied. Mixture proportions are given in Table 3.1.

Two of the five shot spheres, g and k, experienced excessive leakage when filled with the liquid explosive, nitromethane. The WES inspectors at the jobsite considered cavities i, j, and k satisfactory when completed by the contractor; however, cavities g and h contained rough surfaces and joints and were out of round. Discussion with responsible individuals at the site revealed that due to the tight work schedule, it would not be

possible to conduct additional work in cavities g and h. Additional coats of the sealing agent were applied as an alternative. Apparently the labor strike which occurred during the course of the work and the subsequent accelerated construction pace had a detrimental effect on the quality of work. The use of relatively inexperienced personnel or experienced personnel working in jobs which were beyond their operational efficiency quite possibly could have resulted in substandard work. The American Concrete Institute in "Recommended Practice for the Application of Mortar by Pneumatic Pressure"<sup>6</sup> states: "Because so much of the quality and satisfactory use of shotcrete depends on the skill of workmen, it is desirable that the foreman, nozzle men, and gunmen, before employment on shotcrete work, give evidence that each has done satisfactory work in similar capacities elsewhere for a sufficient period of time to be fully qualified to properly perform the work in accord with the requirements of the related specifications." Rough surfaces or even irregular sphere shape should have little effect on the structural integrity of the sphere. Construction joints, if they are not excessively deep or numerous, should not be considered detrimental. However, if a pattern of joints existed in a particular area, as might result from short and/or intermittent operations, a fracture-prone section which would develop tensile cracks under load could result.

In order to check the consistency and strength of the shotcrete mixture in the field, 2-inch cubes taken from representative batches were cast, sent to the laboratory, and tested for compressive strength. Results are given in the following tabulation:

---

<sup>6</sup>ACI Standard 805-51, American Concrete Institute, Proceedings, vol 47

(May 1951), pages 709-719.

Hole No.	Compressive Strength Average of 18 Specimens
	psi
U18g	5150
U18h	5040
U18i	4670
U18j	5420
U18k	4840
Average	5020

Although there were no compressive strength requirements in the construction of the cavities, the average strength of 5020 psi is indicative of a satisfactory mixture and mixing procedure.

Despite the unfortunate experience with cavities g and h, the shotcrete approach for finishing the cavities should not necessarily be judged unsatisfactory. Shotcrete was successfully used in the Pre-SCHOONER cavities. It should be noted that, although cavities g and h were considered potentially unsound, cavities g and k actually experienced excessive leakage. Since the cavities were judged only by visual inspection, it is possible that some flaws or cracks existed which could not be detected visually. Also, any foundation movement or settlement of the foundation rock during filling could result in fracture of the brittle shotcrete. Wire mesh reinforcing would prevent a complete tensile failure during a foundation rock slippage, but would not prevent tensile cracks in the shotcrete which would allow leakage. Test filling with water or similar liquid would reveal cracks which could be repaired prior to filling with the explosive.

### 3.3 GROUT

A series of NX-size holes were drilled at various positions around the expected crater periphery and grouted with colored grout containing



serrated colored tapes to assist in the postshot crater investigation.

Mixture proportions of the grouting material are given in Table 3.1.

The color scheme for the holes is indicated below:

Hole No. NCG-	Color Grout	Color Tape
26	Natural	White
25	Natural	White
35	Maroon	Blue
37	Maroon	Blue
38	Beige	Red
39	Maroon	None
40	Beige	Red
41	Maroon	Blue
42A	Beige	None
44	Beige	Red

Postshot excavation or redrilling of the holes will determine if the grout served the desired purpose of containing the serrated tapes and acting as the surrounding medium in the cratering phenomena. Results of density, ultrasonic pulse velocity, and compressive strength tests on specimens sent to the laboratory and tested on the shot date (approximately 21 days age) are given below:

Specimen No.	Density pcf	Ultrasonic Pulse Velocity ft/sec	Compressive Strength psi
1	170.08	11,230	5820
2	169.46	11,180	5130
3	173.19	11,570	6760
4	168.83	11,030	5430
5	170.08	11,470	6530
6	166.96	10,990	5200
Average	169.77	11,250	5810

The results are considered very satisfactory for field-mixed grout with the consistency required.

Table 3.1

Shotcrete and Grout Materials and Mixture Proportions

Item	Ingredients	Specific Gravity	Unit Weight (Solid)	Solid Volume per 1-Bag Batch	Weight per 1-Bag Batch
			pcf	foot <sup>3</sup>	pounds
Shotcrete	Type III portland cement	3.15	196.24	0.479	94.00
	NIS alluvium sand	2.59	161.36	1.748	282.0
	Gypsum base accelerator	2.75	171.32	0.117	20.0
	Water	1.00	62.30	0.905	56.4
Grout	Type III portland cement	3.15	196.24	0.479	94.00
	Magnetite sand	4.65	289.69	0.621	180.0
	Coloring	--	--	--	5.0
	Water	1.00	62.30	0.754	47.0

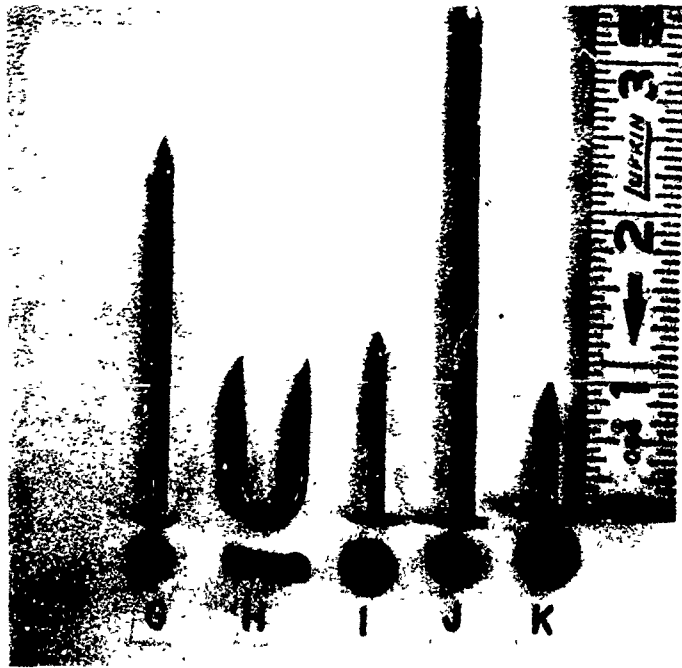

Figure 3.1 Types of nails used for postshot identification of ejecta from different holes. Letters are individual hole designations.

CHAPTER 4  
STEM EVALUATION

To evaluate the stem design for the DUGOUT experiment, a survey and examination were conducted of the stem ejecta at the crater site. Appendix A gives the location and description of individual pieces.

Reports of responsible observers of the shot indicate that the stems performed satisfactorily with respect to causing the expected crater phenomena of the continuous media. Additional substantiation of this belief can be gleaned from the results. The crater, or ditch, was apparently much longer than predicted. It is logical to assume that this would not have occurred if the stems had vented prematurely.

General observations of stem ejecta are as follows:

1. Most of the stemming material located inside the crater came from holes U18h, U18i, and U18j. Only one piece of stem from U18g and none from U18k were located inside the crater.
2. The only pieces of steel located inside the crater (position 2<sup>7</sup>) were from U18i.
3. Pieces of concrete stem of all colors, with the exception of yellow, were located inside the crater.
4. Pieces of stem inside the crater were concentrated in four general areas as follows: (1) Band of material (position 12) extending up the side slope near the southwest corner of the crater, (2) band of material (positions 5, 6, 7, and 8) extending up the east end slope,

---

<sup>7</sup> See Appendix A and Figure A1 for location of designated positions and observations.

(3) band of material (positions 9, 10, and 11) extending up the side slope near the northeast corner of the crater, (4) crater bottom (positions 1, 2, 3, and 4). The top collars of stem from U18i and U18j were located in the crater bottom at the east and west ends, respectively.

5. Stem material from all holes, with the exception of U18i, was located in the ejecta material outside the crater.

6. Stem material of each of the four colors from U18j was located outside the crater. Only green-colored stem material from U18g, U18h, and U18k was located in the ejecta.

7. The amount of stem located seemed to be a function of its depth from the surface. The majority color was green with decreasing amounts down to yellow.

8. In general, the gradation of the stem material became coarser as the distance from the detonation increased. Most of the yellow and brown stem ejecta was completely crushed while the terra cotta and green stem particles, particularly the green, were located in large pieces.

9. Calyx faces located were relatively smooth, indicating bond failure.

10. All steel located outside the crater came from U18j. Lengths given in Appendix A are approximate, due to deformations of the bars at detonation.

To assist in evaluating the structural functioning of the stems, each piece of stem located was given a cursory examination for crack pattern, particle size, and bond to basalt. It is believed that the forces and stresses as indicated by mode and type of failure experienced by the individual bits of stem ejecta give an indication of the overall functioning,

of the stem. Accordingly, the following observations were made from the descriptions of located particles of stem ejecta.

1. Most of the brown and yellow pieces located were relatively small (minus 1-1/2-inch material) and appeared to have undergone terrific forces, probably compressive, as indicated by the pulverized or highly fractured condition. Stem particle size was comparable to basalt particle size; little bond failure was observed. It should be noted that all of the yellow and part of the brown stem portions were in or below the keys.

2. The pieces of terra cotta and green stem located were generally larger than the brown or yellow particles, but were comparable in size to the basalt in immediate area. Broken surfaces indicated predominantly tensile spalling and fracturing with some bond failure. Tensile spalling was to be expected in the top portion of the stem. It was recognized that the concrete basalt interface presented a weakened surface and some failure here was expected. However, as indicated in positions 7, 11, and 14, there was evidence of good bond and effective monolithic action.

3. Practically all of the steel located was from U18j stem and in one general area (see Appendix A). Several pieces were apparently whole rods and many were the oversize Nos. 11 and 12 bars, but there appeared to be no relation between these phenomena. The predominant type of fracture appeared to be a horizontal shear (angle) break. Some tensile necking was observed.

It would appear from the observations and deductions noted that the stems designed for the project were effective. Apparently the lower part of the stems, i.e. from the keys down, failed in compression and shear with the steel taking predominant shear stresses. Tensile spalling and

bond failure were evident in the upper stem portions; however, there was evidence of conjugate concrete-basalt action in this area.

## APPENDIX A: POSTSHOT STEMMING EVALUATION

### Concrete Ejecta

Small amounts of completely crushed stem were located in other areas which allowed identification of steel. However, these quantities were so small that they are considered insignificant.

Position No.*	Location		Remarks
	Preshot	Postshot	
1	U18j Green (Surface collar)	West end slope, approximately 20 feet up- slope from cra- ter bottom.	Complete 4-foot-diameter section contained within 2-foot length of corrugated metal. Appeared to have popped out of overburden at detonation.
2	U18i Brown	Crater bottom, approximately 20 feet west of original U18i.	Extensive amount of fine stemming and basalt material, almost com- pletely pulverized.
3	U18i Terra cotta	Crater bottom approximately 5 feet north of original U18i.	Numerous small pieces, 1-1/2-inch maximum, of crushed concrete stem and aggregate.
4	U18i Terra cotta	Crater bottom, approximately 30 feet east of original U18i.	Numerous pieces of stem ranging in size from single pieces of aggre- gate up to one piece approximately 18 inches wide and 8 inches long. Material all well shattered; larger pieces had extensive cracks and in some cases could be broken by hand. Appearance indicated tensile spal- ling failure.
5	U18i Green (Surface collar)	Crater bottom, foot of east end slope.	Complete 4-foot-diameter section in 2-foot length of corrugated metal with 3-foot-diameter stem approxi- mately 2-1/2 feet long, almost in- tact; appeared to have popped out at detonation with some basalt ad- hering to the stem.

\* See Figure A1 for layout of positions.



Position No.	Location		Remarks
	Preshot	Postshot	
6	U18i Green	East end slope, approximately 10 feet upslope from crater bottom.	Several pieces of stem; most ranged in size from 6 inches to 1-1/2 feet.
7	U18h Green	East end slope, approximately 20 feet upslope from crater bottom.	Large section of stem, approximately 4-1/2 feet long, broken horizontally approximately 2 feet from end. Smooth calyx faces visible in spots while some areas had basalt bonded to the face; some cracking in these sections. Appearance indicated shear and bond failure.
8	U18i Green	East end slope, approximately 40 feet upslope from crater bottom.	Four large pieces of stem and several smaller ones. Large pieces (1-1/2- to 4-foot sizes) approximately same size as basalt in the vicinity. Slight cracking. Apparent bond and shear failures.
9	U18n Green	North side slope, approximately 20 feet upslope from crater bottom and approximately 15 feet west of original U18g.	Extensive amount of stem (1-inch to 1-1/2-foot sizes) scattered in a band approximately 10 feet wide extending up the crater slope. Stem and basalt are approximately the same size in this area.
10	U18g Brown	Crater bottom, approximately 20 feet west of original U18g.	One portion of stem approximately 1-1/2 feet long. Some bond failure and shear fracturing indicated. This piece is surrounded by an extensive amount of stem which is completely crushed, indicating compressive failure.
11	U18h Terra cotta	North side slope, approximately 20 feet upslope from crater bottom and approximately 20 feet	Several large pieces of stem with smooth faces indicating bond failure. Some smaller pieces (1 to 6 inches) around the larger ones. Shear failure also indicated by horizontal and approximately

Position No.	Location		Remarks
	Preshot	Postshot	
11 (cont'd)	U18h Terra cotta	east of original U18h.	45-degree breaks. Several pieces of basalt in this area with smooth calyx faces stained terra cotta color.
12	U18j Terra cotta	South side slope, south of original U18j.	Band of stem, 20 to 25 feet in width, extending from the crater bottom up the side slope to within 20 feet of the crater rim. Size range was 1 inch to 3 feet. Stem size comparable to basalt size in this area.
13	U18k Green (Surface collar)	Approximately 125 feet west of west end of cra- ter rim.	Top section with 4-foot-diameter corrugated metal. Apparent pop-out at time of detonation.
14	U18k Green	Approximately 100 feet west of west end crater rim.	Three-foot-diameter piece of stem approximately 2-1/2 feet long, almost intact. Face indicates bond failure. Concrete entered basalt cracks in the calyx face at time of placement. Upon detonation, cracks were formed in the stem along these basalt cracks, indicating monolithic action. This piece of stem was moved during trenching operations prior to photographing and could not be located after movement.
15	U18k Green	West end crater lip.	These pieces of stem were located upon excavation of the west trench. Layer of pieces was positioned at approximately the midheight of basalt in ejecta extending from the crater rim outward. Appearance indicated tensile spalling failure.
16	U18j Green	Back slope, south lip, due south of original U18k.	Several pieces of stem extended in a band approximately 10 feet wide from near crater rim down back slope of lip. Smooth faces and irregular horizontal breaks

Position No.	Location		Remarks
	Preshot	Postshot	
16 (Cont'd)	U18j Green		indicated a combination of bond and shear failure.
17	U18j Terra cotta	Back slope, south lip, due south of a point middle of original U18i and U18j.	Approximately 20-foot-diameter area centered approximately 30 feet south of crater rim. Stem material in this area was completely crushed, indicating compressive or tensile spalling failure.
18	U18j Green	Back slope, south lip, due south of a point 15 feet east of original U18j.	Approximately 40-foot-diameter area centered approximately 80 feet south of crater rim. Extensive amount of stem ranging in size from completely crushed to 2 feet. Appearance indicates tensile spalling failure.
19	U18h Green (Surface collar)	Back slope, southeast lip, due south of a point 25 feet east of original U18g.	Complete section of 4-foot-diameter stem contained in corrugated metal. Located approximately 25 feet from crater lip. Apparently popped out of overburden at detonation.
20	U18g Green (Surface collar)	Approximately 20 feet east of east end crater rim.	Extensive amount of stem including 4-foot-diameter surface section in corrugated metal covered an area approximately 25 feet in diameter. Appearance indicated surface pop-out and tensile spalling of stem below the surface.
21	U18j	Back slope, north lip.	Band of concrete stem and steel approximately 90 feet wide (beginning due north of U18i) extending west down the back slope of the crater lip. Location of particular points within this band and description of the pieces in this area are as follows:
21-A	U18j Brown	3 feet north of crater rim, north of original U18k.	Small amount of concrete stem ranging in size from 6 inches to completely pulverized. Apparent compressive failure.

Position No.	Location		Remarks
	Preshot	Postshot	
21-B	U18j Brown	8 feet north of crater rim, north of original U18i.	Area of concrete stem ranged in size from 6 inches to completely pulverized; majority pulverized. Six-inch pieces extensively cracked and could be broken by hand.
21-F	U18j Yellow	85 feet north of crater rim, north of original U18i.	Small amount of stem ranged in size from 6 inches to completely crushed, indicating compressive failure.
21-J	U18j Brown	150 feet north of crater rim, north of a point middle of origi- nal U18i and U18j.	Extensive amount of stem ranged in size from 1-1/2 feet to completely crushed. Appeared to be a com- pressive failure.
21-K	U18j Yellow	180 feet north of crater rim, north of original U18i.	One piece of stem approximately 1 by 2 feet with pieces of steel still intact. Also, an area of completely crushed stem.
21-L	U18j Yellow	210 feet north of crater rim, north of original U18j.	Area of concrete stem ranging in size from 6 inches to completely crushed. Apparent compressive failure.

### Steel Ejecta

Position No.	Location		Length	Bar Size (No.)	Remarks
	Preshot	Postshot			
2	U18i	See concrete stem, same position.		10	Several pieces of steel partially covered with basalt which made it impossible to determine any lengths. Visible breaks were as follows: 4 - horizontal shear. 1 - 45-degree break (necking). 1 - 45-degree break (no necking).
21-B	U18j	See concrete, same position.	2 feet 6 inches	10	Tension (slight necking) and horizontal shear.
			2 feet 8 inches	10	Horizontal shear.
			2 feet 9 inches	10	Tension (necking) and horizontal shear.
			3 feet 9 inches	10	Horizontal shear.
			5 feet 0 inches	10	Horizontal shear.
21-C	U18j	45 feet north of crater rim, north of a point midway between original U18i and U18j.	6 feet 4 inches	10	Apparent whole rod.
			4 feet 8 inches	11	Horizontal shear.
			4 feet 4 inches	11	Horizontal shear each end.
			1 foot 7 inches	10	45-degree shear each end.
21-D	U18j	85 feet north of crater rim, north of original U18j.	2 feet 8 inches	11	Horizontal shear.
			1 foot 4 inches	11	45-degree shear and tension (necking).
			1 foot 1 inch	11	45-degree shear and tension (necking).
			3 feet 9 inches	11	Horizontal shear.
			3 feet 2 inches	10	Horizontal shear.
21-E	U18j	75 feet north of crater rim,	6 feet 5 inches	10	Apparent whole rod.

Position No.	Location		Length	Bar Size (No.)	Remarks
	Preshot	Postshot			
21-E (Cont'd)		north of a point midway between original U18i and U18j.			
21-F	U18j	See concrete, same position.	3 feet 2 inches	10	Horizontal shear.
21-G	U18j	85 feet north of crater rim, north point midway between original U18i and U18j.	2 feet 8 inches	10	Horizontal shear.
			4 feet 7 inches	12	Horizontal shear and tension (tensile necking).
21-H	U18j	100 feet north of crater rim, north of original U18j.	3 feet 4 inches	12	Horizontal shear.
			0 feet 7 inches	10	45-degree shear each end.
21-I	U18j	45 feet north of crater rim, north of original U18k.	6 feet 7 inches	11	Apparent whole rod.
21-J	U18j	See concrete, same position.	3 feet 0 inches	11	45-degree shear each end.
			1 foot 0 inches	10	45-degree shear each end.
			6 feet 4 inches	11	Apparent whole rod.
			6 feet 0 inches	11	Apparent whole rod.
			6 feet 0 inches	12	Apparent whole rod.
			6 feet 3 inches	10	Apparent whole rod.
			5 feet 8 inches	11	Apparent whole rod.
			6 feet 0 inches	10	Apparent whole rod.
			6 feet 4 inches	10	Apparent whole rod.
			6 feet 0 inches	10	Apparent whole rod.
			7 feet 6 inches	10	Apparent whole rod.
			5 feet 0 inches	10	45-degree break (necking).

Position No.	Location		Length	Bar Size (No.)	Remarks
	Preshot	Postshot			
21-J (Cont'd)			3 feet 8 inches	10	45-degree break (necking).
			2 feet 8 inches	10	Horizontal shear and tension.
			6 feet 0 inches	10	Horizontal shear and 45-degree break (necking).
21-K	U18j	See concrete, same position.	0 feet 11 inches	10	Tension each end.
			0 feet 7 inches	10	45-degree shear each end.
			0 feet 9 inches	10	45-degree shear each end.
			1 foot 7 inches	10	45-degree shear each end.
			1 foot 3 inches	11	45-degree shear each end.
			1 foot 9 inches	11	Horizontal and 45-degree shear.
			1 foot 9 inches	11	Horizontal and 45-degree shear.
			1 foot 10 inches	11	Horizontal and 45-degree shear.
21-L	U18j	See concrete, same position.	2 feet 2 inches	12	Horizontal shear and tension.
			2 feet 9 inches	11	Horizontal shear (necking).
			2 feet 7 inches	10	Horizontal shear and 45-degree shear.
			1 foot 7 inches	11	Horizontal shear and 45-degree shear.
21-M		100 feet north of crater rim, north of a point midway between original U18j and U18k.	3 feet 4 inches	12	Horizontal shear and tension.
21-N		170 feet north of	3 feet 0 inches	11	Horizontal shear and tension.

Position No.	Location		Length	Bar Size (No.)	Remarks
	Preshot	Postshot			
21-N (Cont'd)		crater rim, north of original U18j.	6 feet 4 inches	12	Apparent whole rod.
21-0	U18j	75 feet north of crater rim, north of original U18i.	1 foot 2 inches	11	45-degree shear each end.



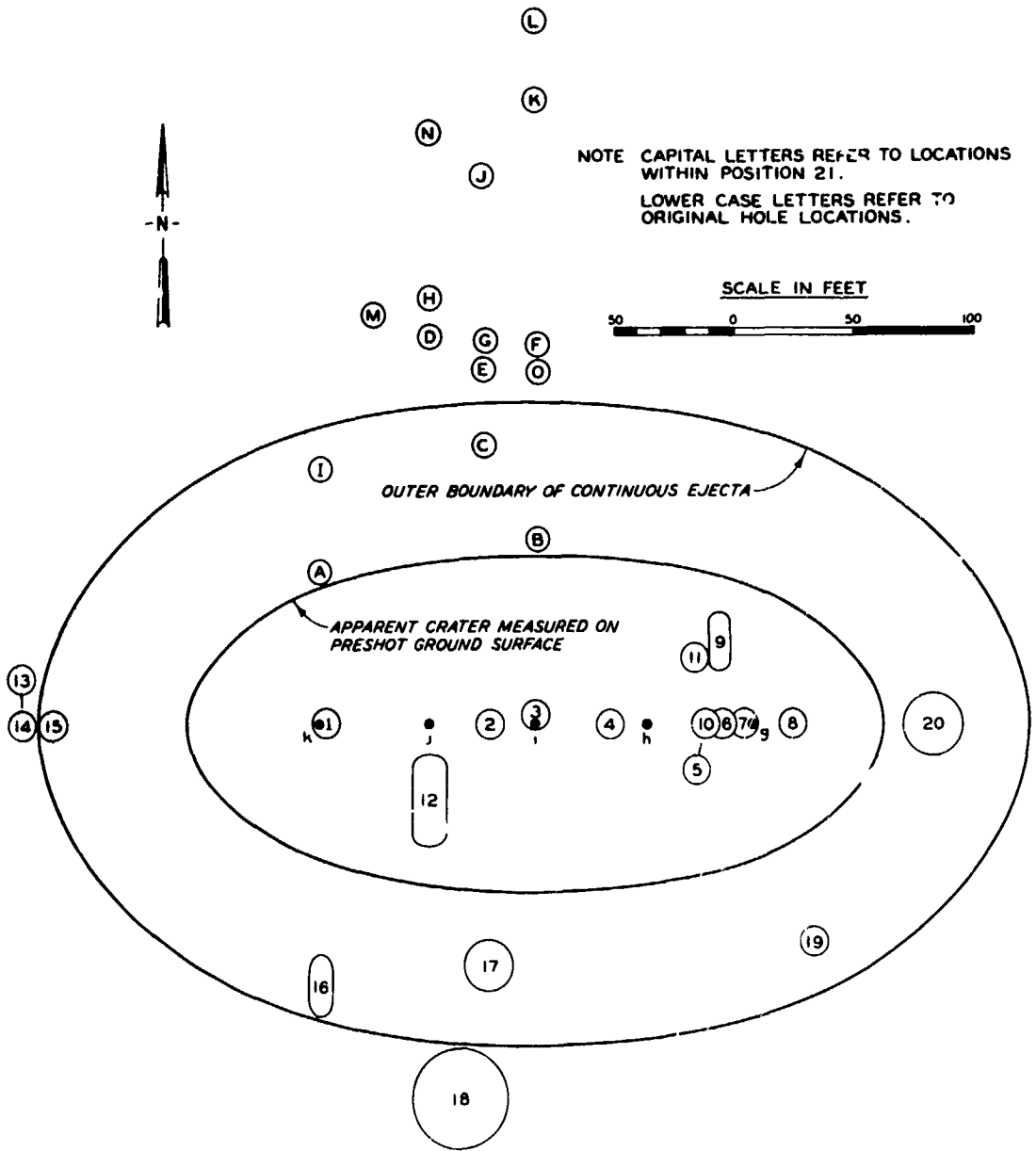

Figure A1. Layout of ejecta location positions.