

box # 231

DNA 6036F

OPERATION IVY 1952

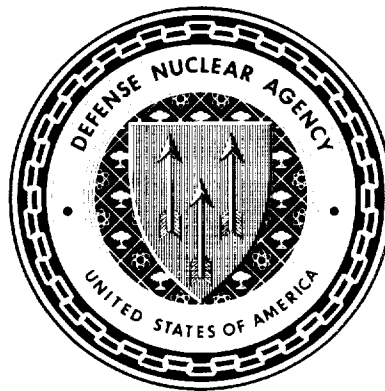

United States Atmospheric Nuclear Weapons Tests
Nuclear Test Personnel Review

Prepared by the Defense Nuclear Agency as Executive Agency
for the Department of Defense

DARE#
23589

Destroy this report when it is no longer
needed. Do not return to sender.

PLEASE NOTIFY THE DEFENSE NUCLEAR AGENCY,
ATTN: STTI, WASHINGTON, D.C. 20305, IF
YOUR ADDRESS IS INCORRECT, IF YOU WISH TO
BE DELETED FROM THE DISTRIBUTION LIST, OR
IF THE ADDRESSEE IS NO LONGER EMPLOYED BY
YOUR ORGANIZATION.



UNCLASSIFIED

SECURITY CLASSIFICATION OF THIS PAGE (When Data Entered)

REPORT DOCUMENTATION PAGE		READ INSTRUCTIONS BEFORE COMPLETING FORM
1. REPORT NUMBER DNA 6036F	2. GOVT ACCESSION NO.	3. RECIPIENT'S CATALOG NUMBER
4. TITLE (and Subtitle) OPERATION IVY: 1952		5. TYPE OF REPORT & PERIOD COVERED Technical Report
		6. PERFORMING ORG. REPORT NUMBER KT-82-026(R)
7. AUTHOR(s) F.R. Gladeck, J.H. Hallowell, E.J. Martin, F.W. McMullan, R.H. Miller, R. Pozega, W.E. Rogers, R.H. Rowland, C.F. Shelton, L. Berkhouse (continued)		8. CONTRACT OR GRANT NUMBER(s) DNA 001-79-C-0472
9. PERFORMING ORGANIZATION NAME AND ADDRESS Kaman Tempo P.O. Drawer QQ (816 State Street) Santa Barbara, CA 93102		10. PROGRAM ELEMENT, PROJECT, TASK AREA & WORK UNIT NUMBERS Subtask U99QAXMK506-09
11. CONTROLLING OFFICE NAME AND ADDRESS Director Defense Nuclear Agency Washington, D.C. 20305		12. REPORT DATE 1 December 1982
		13. NUMBER OF PAGES 364
14. MONITORING AGENCY NAME & ADDRESS (if different from Controlling Office)		15. SECURITY CLASS. (of this report) UNCLASSIFIED
		15a. DECLASSIFICATION/DOWNGRADING SCHEDULE N/A since UNCLASSIFIED
16. DISTRIBUTION STATEMENT (of this Report) Approved for public release; distribution unlimited.		
17. DISTRIBUTION STATEMENT (of the abstract entered in Block 20, if different from Report)		
18. SUPPLEMENTARY NOTES This work was sponsored by the Defense Nuclear Agency under RDT&E RMSS Code B350079464 U99QAXMK50609 H2590D. For sale by the National Technical Information Service, Springfield, Virginia 22161		
19. KEY WORDS (Continue on reverse side if necessary and identify by block number) Nuclear testing Nuclear Test Personnel Review (NTPR) IVY Pacific Proving Ground Enewetak MIKE KING		
20. ABSTRACT (Continue on reverse side if necessary and identify by block number) IVY was a two-detonation atmospheric nuclear weapon test series conducted during October and November of 1952 at Enewetak Atoll in the Marshall Islands. One of the two events was designated MIKE and was the first thermonuclear or hydrogen bomb. Report emphasis is on the radiological safety of the personnel. Available records on personnel exposure are summarized.		

DD FORM 1473
1 JAN 73

EDITION OF 1 NOV 65 IS OBSOLETE

UNCLASSIFIED

SECURITY CLASSIFICATION OF THIS PAGE (When Data Entered)

UNCLASSIFIED

SECURITY CLASSIFICATION OF THIS PAGE(When Data Entered)

7. Authors (continued)

S. Davis, M.K. Doyle, and C.B. Jones

UNCLASSIFIED

SECURITY CLASSIFICATION OF THIS PAGE(When Data Entered)

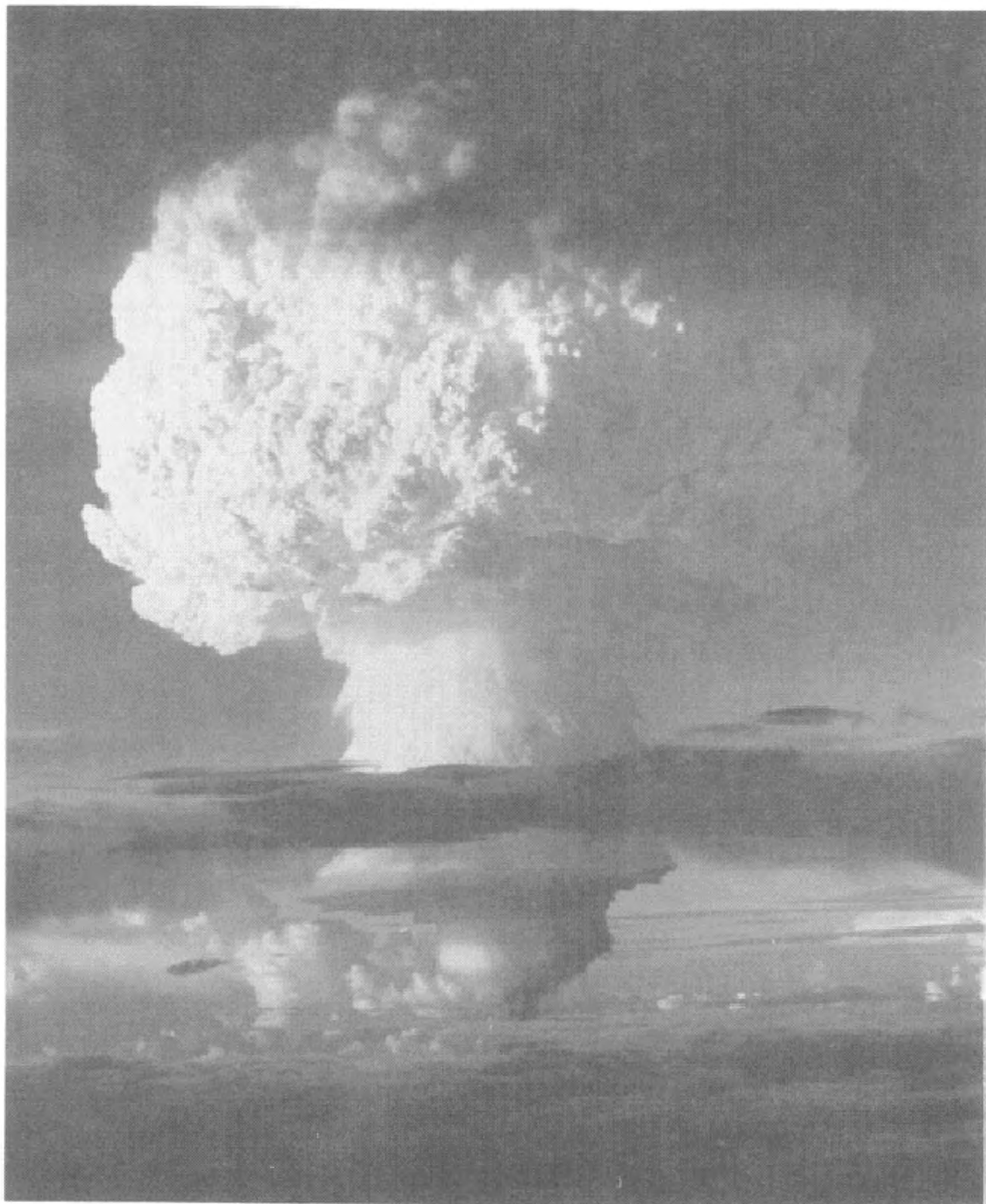

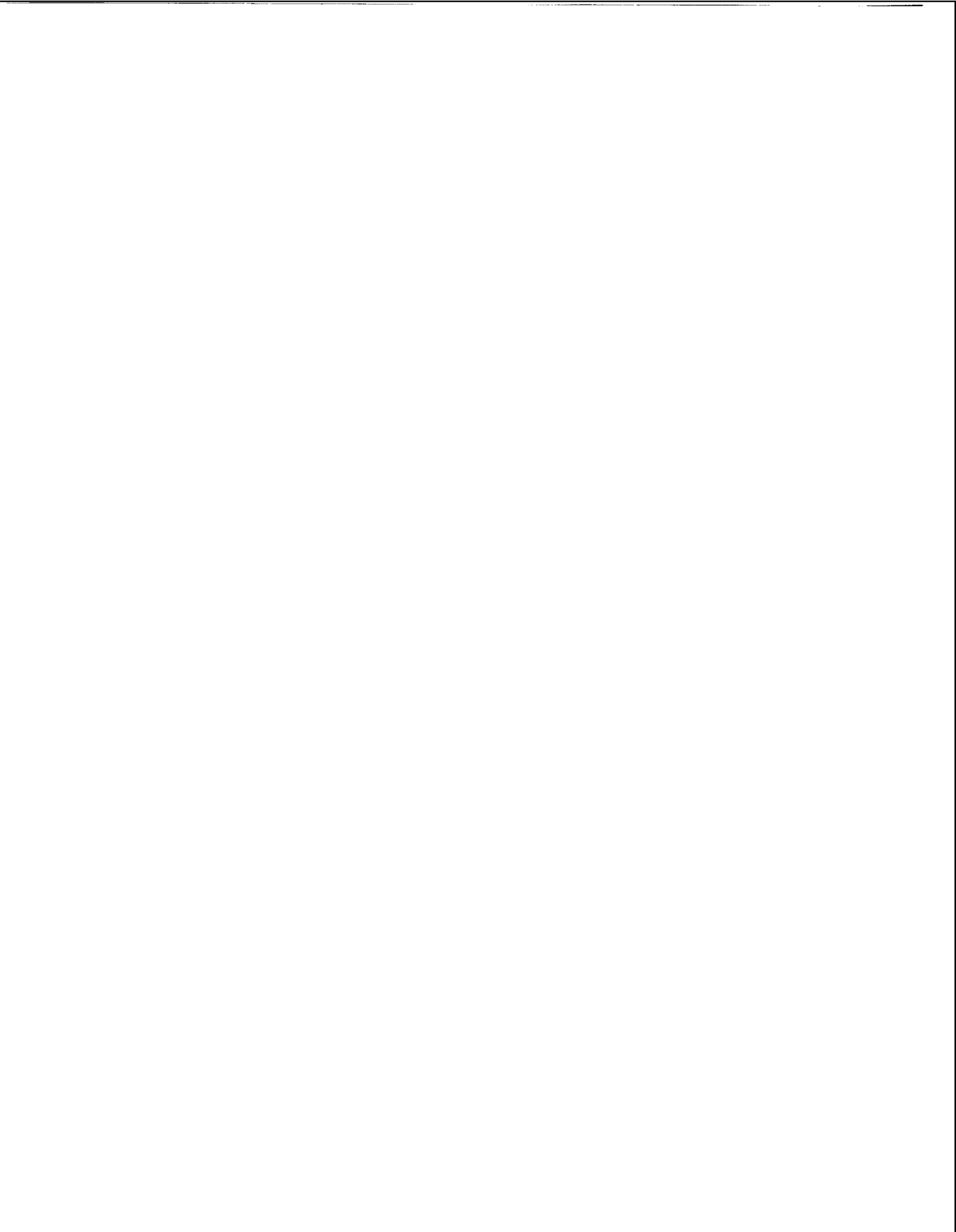

FACT SHEET

IVY was an atmospheric nuclear weapons test series held in the Atomic Energy Commission's (AEC) Pacific Proving Ground at Enewetak Atoll in the Marshall Islands during autumn 1952. The series consisted of the two detonations listed below.

Assigned Name	Local Date	Location	Yield ^a
MIKE	1 Nov	Eluklab Island; surface	10.4 MT
KING	16 Nov	Airburst (1,480 feet [440 meters]) over reef off Runit Island	500 KT

^aOne kiloton equals the approximate energy release of the explosion of one thousand tons of TNT; one megaton equals the approximate energy release of the explosion of one million tons of TNT.

HISTORICAL BACKGROUND

President Truman made the decision to pursue the development of thermonuclear weapons in 1950, and the IVY series was a key step in this development. MIKE was an experimental device and produced the first thermonuclear detonation, in which a substantial portion of its energy was generated by the fusion, or joining, of hydrogen atoms. KING was a stockpile weapon, modified to produce a large yield. It was dropped from a B-36 bomber. The energy from KING was generated by the fission, or splitting, of plutonium atoms. These were the largest nuclear explosions to that time.

JOINT TASK FORCE 132

Joint Task Force 132 (JTF 132) was the organization that conducted the IVY test series. Elements of the four services, the AEC and other Federal government agencies, and civilians from government laboratory organizations and contractors made up this organization. Commander JTF 132 reported to the Joint Chiefs of Staff, but was also designated the AEC's agent in conducting the

tests. The joint nature of this test organization resulted from the requirements of the Atomic Energy Act of 1946. This legislation placed atomic energy development under civilian control; however, the remoteness of the IVY Series test site required a military organization for physical security and technical and logistical support.

The total number of personnel involved in the task force was nearly 11,650, of which 9,350 were military and 2,300 were civilians. Most of the civilians and over 6,600 of the military personnel operated from Enewetak Atoll and from task force ships that were based there. Most of the remaining military were Air Force personnel who were based at Kwajalein, 360 nmi (667 km) southeast of Enewetak.

TEST PLANNING

The safety of the task force personnel conducting the test series was an important factor in planning the conduct of the tests. Pretest measures taken to ensure the safety of personnel were:

1. Modification of ships and aircraft, including the installation of "washdown" systems aboard ships to prevent radioactive fallout accumulation and the installation of filters on aircraft pressurization systems to prevent radioactive particles from entering aircraft.
2. Design of special protective clothing, including a lead-cloth shroud for aircraft pilots operating near the radioactive cloud.
3. A training program in radiation safety procedures.
4. The establishment of a technical support unit whose responsibility was to provide the task force with expert assistance in radiation safety, including monitoring of radiation, decontamination of personnel, laboratory support, maintenance of exposure records, and maintenance and calibration of radiation detection equipment.
5. The establishment of a meteorology group whose responsibility was to predict the direction of the winds aloft to avoid conducting the tests during times when radioactive fallout might be carried in the direction of the task force or inhabited islands.
6. The establishment of a program for the evacuation of all personnel from Enewetak Atoll for the MIKE test and the preparation of plans for emergency evacuation of task force personnel from Bikini and Kwajalein. Marshall Islanders living at Ujelang were placed aboard a Navy

ship just before the MIKE detonation in readiness for movement to safety if the fallout moved to the southwest.

7. The establishment of procedures for issuing film badges to individuals whose activities might expose them to nuclear radiation so that exposure records could be kept. About 2,100 of the task force personnel received these badges.

TEST OPERATIONS AND EXPOSURES

The conduct of the tests went essentially as planned. The experimental MIKE device performed successfully and the winds remained favorable, carrying the radioactive fallout northwesterly over the open ocean. The generally smooth MIKE operations were marred by an accident when a single-place aircraft used for cloud sampling was lost at sea with its pilot. This led to radiation exposures from 10 roentgens (R) to 17.8 R for the 7-man aircrew that flew to assist the downed plane, considerably greater than the maximum permissible exposure (MPE) (3.9 R) of the operation. This crew crossed a zone of fallout in order to reach the area of the downed plane as quickly as possible.

A crew of twelve in a second aircraft was also overexposed when caught in fallout debris while on a photographic mission during the MIKE shot. The highest exposure for this crew was 11.6 R. Other than these two events, no other cases exceeded the established MPE during IVY.

Fallout occurred on JTF 132 ships and on Parry and Enewetak islands following MIKE and KING. A recent calculation based on data collected aboard three ships, which were anchored near the islands, indicates that cumulative personnel exposures due to this fallout was at maximum from about 0.25 to 0.53 R for personnel continuously at Enewetak from 4 November to 31 December, but only if the effects of weathering on the deposited fallout and shielding by working and living quarters are ignored. Actual exposures were probably much lower.

Nearly 90 percent of the recorded IVY exposures were less than 1 roentgen. The exposures are summarized in the following table.

IVY, Joint Task Force 132 Personnel Exposures

	No. of Persons Badged	Exposure Ranges (roentgens)				High Recorded
		0	0.001-0.999	1.000-2.999	Over 3	
Total Army	164	39	98	26	1	3.3
% of Total		24	60	16	<1	
Total Navy	810	244	526	39	1	3.1
% of Total		30	65	5	<1	
Total Air Force	675	78	541	34	22	17.6
% of Total		12	80	5	3	
Total Marine Corps	14	2	4	8	0	2.8
% of Total		14	29	57	0	
Total Other Gov't	367	45	245	74	3	3.2
% of Total		12	67	20	<1	
Total	2,030	408	1,414	181	27	17.6
% of Total		20	70	9	<1	

PREFACE

Between 1945 and 1962, the U.S. Atomic Energy Commission (AEC) conducted 235 atmospheric nuclear weapon tests at sites in the United States and in the Pacific and Atlantic oceans. In all, about 220,000 Department of Defense (DOD) participants, both military and civilian, were present at the tests. Of these, approximately 142,000 participated in the Pacific test series and approximately another 4,000 in the single Atlantic test series.

In 1977, 15 years after the last aboveground nuclear weapon test, the Center for Disease Control (CDC) of the U.S. Department of Health and Human Services noted more leukemia cases than would normally be expected among about 3,200 soldiers who had been present at shot SMOKY, a test of the 1957 PLUMBBOB Series. Since that initial report by the CDC, the Veterans Administration (VA) has received a number of claims for medical benefits from former military personnel who believe their health may have been affected by their participation in the weapon testing program.

In late 1977, the DOD began a study that provided data to both the CDC and the VA on potential exposures to ionizing radiation among the military and civilian personnel who participated in the atmospheric testing 15 to 32 years earlier. In early 1978, the DOD also organized a Nuclear Test Personnel Review (NTPR) to:

- Identify DOD personnel who had taken part in the atmospheric nuclear weapon tests
- Determine the extent of the participants' exposure to ionizing radiation
- Provide public disclosure of information concerning participation by DOD personnel in the atmospheric nuclear weapon tests.

This report on Operation IVY is one of many volumes that are the product of the NTPR. The Defense Nuclear Agency (DNA), whose Director is the executive agent of the NTPR program, prepared the reports, which are based on

military and technical documents reporting various aspects of each of the tests. Reports of the NTPR provide a public record of the activities and associated radiation exposure risks of DOD personnel for interested former participants and for use in public health research and Federal policy studies.

Information from which this report was compiled was primarily extracted from planning and after-action reports of Joint Task Force 132 (JTF 132) and its subordinate organizations. Documents were desired that accurately placed personnel at the test sites so that their degree of exposure to the ionizing radiation resulting from the tests could be assessed. The search for this information was undertaken in archives and libraries of the Federal Government, in special collections supported by the Federal Government, and by discussion or review with participants.

For IVY, the most important archival source is the National Archives and Record Center, Modern Military Branch, Washington, D.C. The Naval Archives at the Washington Navy Yard also was helpful, as was the collection of documents assembled by the Air Force Weapons Laboratory (AFWL) Historian, the collection now being housed in the AFWL Technical Library at Kirtland Air Force Base, Albuquerque, New Mexico. Other archives searched were the Department of Energy (DOE) archives at Germantown, Maryland, its Nevada Operations Office (DOE/NV) archives at Las Vegas, and the archives of the Test Division of the Los Alamos National Laboratory.

JTF 132 exposure records were retrieved from the National Archives, and an additional file of exposure-related documents that had been microfilmed by the Reynolds Electrical and Engineering Company, Inc., support contractor for DOE/NV, was also useful.

There is little primary documentation of personnel movement in areas of potential radiation exposure. This has been compensated for, where possible, with inferences drawn from secondary sources and the exposure records themselves.

The work was performed under RDT&E RMSS B350079464 U99 QAXMK 506-09 H2590D for the Defense Nuclear Agency by personnel from Kaman Tempo and R.F. Cross Associates as subcontractor. Guidance was provided by Mr. Kenneth W. Kaye of Defense Nuclear Agency.

CONTENTS

	<u>Page</u>
FACT SHEET	1
PREFACE	5
ILLUSTRATIONS	13
TABLES	15
<u>Chapter</u>	
1 OVERVIEW	17
Introduction	17
Purpose	17
Historical Background	18
Report Organization	19
Nuclear Tests and Radiation Exposures	20
Experimental Program	22
Weapon Development	23
Yield Measurements	23
Diagnostic Measurements	24
Effects Experiments	26
Environmental Measurements	26
Systems Response Measurements	27
Oceanic Testing Operations	28
Marshall Islands Setting	28
Physical Condition in 1952	32
Radiological Conditions in 1952	32
Special Problems in Oceanic Testing	33
Joint Task Force 132	36
Pre-IVY Period	37
Military at the Pacific Proving Ground	38
Civilians at the Pacific Proving Ground	42

CONTENTS (continued)

<u>Chapter</u>		<u>Page</u>
1 (cont)	Buildup	42
	Construction	42
	Buildup of Personnel and Units	45
	The Task Force in Place	47
	Task Group 132.1 (Scientific)	56
	Task Group 132.2 (Army)	58
	Task Group 132.3 (Navy)	58
	Task Group 132.4 (Air Force)	60
2	RADIOLOGICAL SAFETY	64
	Radiological Safety Planning	64
	Task Group 132.1 (Scientific)	67
	Radiation Control Group	70
	Laboratory and Analysis Group	72
	Decontamination Group	73
	Special Monitoring Group	73
	Task Group 132.2 (Army)	73
	Task Group 132.3 (Navy)	75
	Task Group 132.4 (Air Force)	76
	Indoctrination and Training	77
	Personnel Protection	83
	Pretest Physical Examinations	83
	Radiological Safety Standards	84
	Radsafe Instrumentation	91
	Film Badges	93
	Major Equipment Modification	95
	Ship Modification	95
	Aircraft Modification	96
	Pre-event Safety	102
	Security Perimeter	102
	Weather and Fallout Prediction	103
	Radiation Exclusion Area	107

CONTENTS (continued)

<u>Chapter</u>		<u>Page</u>
2 (cont)	Offsite Safety and Monitoring	107
	Evacuation	109
	Postevent Safety	109
	Early Radiation Surveys	110
	Sample Recovery Techniques	111
	Particle Sample Removal	111
	Gas Sample Removal	113
	Decontamination	114
	Shipments from the Pacific Proving Ground	117
	Release of Naval Vessels from the Pacific Proving Ground	117
3	DOD EXPERIMENTAL PROGRAM	118
	Task Unit 132.1.1 Activities	122
	Helicopter Support	125
	Boat Support	128
	Program 1 -- Radiochemistry	128
	Program 2 -- Progress of the Nuclear Reaction	134
	Program 3 -- Scientific Photography	139
	Program 4 -- Neutron Measurements	146
	Program 5 -- Gamma-Ray Measurements	148
	Program 6 -- Blast Measurements	155
	Program 7 -- Long-Range Detection	164
	Program 8 -- Thermal Radiation Measurements	168
	Program 9 -- Electromagnetic Phenomena	170
	Program 10 -- Timing and Firing	172
	Program 11 -- Preliminary Geophysical and Marine Survey of the Test Area	172
	Task Unit 132.1.7 Activities	174
	Task Unit 132.1.9 Activities	176

CONTENTS (continued)

<u>Chapter</u>		<u>Page</u>
7	SUMMARY OF U.S. AIR FORCE PARTICIPATION IN IVY	238
	Headquarters Joint Task Force 132	239
	Task Group 132.1 (Scientific)	239
	Task Group 132.2 (Army)	239
	Task Group 132.4 (Air Force)	244
	Headquarters Task Group 132.4	244
	Test Support Unit	244
	Test Aircraft Unit	244
	Headquarters Test Aircraft Unit	244
	TAU Sampler Element	244
	TAU Drop Element	245
	TAU Control and Tanker Elements	245
	TAU Effects Element	245
	Test Services Element	246
	TSU Weather Reconnaissance Element	246
	TSU Weather Reporting Element	246
	TSU Communications Element	246
	TSU Search and Rescue Element	247
	TSU Photo Element	247
	Miscellaneous	247
8	SUMMARY OF U.S. MARINE CORPS PARTICIPATION IN IVY	248
9	SUMMARY OF JOINT DEFENSE, ATOMIC ENERGY COMMISSION, OTHER GOVERNMENT AGENCIES, AND CONTRACTOR PARTICIPATION IN IVY	250
	Joint Defense Agency	250
	Atomic Energy Commission	250
	Other Government Agencies	252
	Contractors and Other Organizations	252
10	SUMMARY OF PERSONNEL EXPOSURES	255
	BIBLIOGRAPHY AND REFERENCES	261

CONTENTS (continued)

<u>Appendix</u>		<u>Page</u>
A	ISLAND SYNONYMS	275
B	RADIOLOGICAL SAFETY AND RELATED DOCUMENTS	279
C	RADIOLOGICAL EXPOSURE DATA FOR ISLANDS OF ENEWETAK ATOLL, IVY	301
D	TERMS, ABBREVIATIONS, ACRONYMS, AND UNITS	327
E	INDEX OF PARTICIPATING ORGANIZATIONS	339

ILLUSTRATIONS

Frontispiece: IVY, MIKE thermonuclear detonation, November 1952

<u>Figure</u>		<u>Page</u>
1	The Central Pacific.	29
2	Enewetak Atoll, 1952, with pre-IVY test sites.	30
3	Causeway construction, IVY, MIKE.	35
4	Looking down causeway toward IVY, MIKE ground zero.	35
5	Organization of Joint Task Force 132.	38
6	IVY, MIKE cab.	43
7	Krause-Ogle Box at Station 200 on Boken Island, IVY.	44
8	Organization of Task Group 132.1, IVY.	57
9	Organization of Task Group 132.2, IVY.	59
10	Organization of Task Group 132.3, IVY.	60
11	Organization of Task Group 132.4, IVY.	63
12	Radiological safety organization of Task Group 132.1.1, IVY.	71
13	F-84G sampler aircraft, IVY.	97
14	F-84G sampling panel, IVY.	99
15	Protective lead-glass cloth shroud being placed on sampler pilot, IVY.	100
16	Sample recovery schematic illustration, IVY.	112
17	Plastic ballonet being unrolled inside the Krause-Ogle Box, IVY, MIKE.	136
18	Ballonet inflated with helium, IVY, MIKE.	137
19	Welder attaching hot-spot tubes to IVY, MIKE device.	142
20	Hot-spot tubes leaving IVY, MIKE device.	143
21	IVY, MIKE recovery on Kirunu 5 November 1952.	151
22	IVY, MIKE recovery team inside bunker on Kirunu 5 November 1952.	151
23	Radex areas, project instrumentation locations, and positions of task force ships, IVY, MIKE.	183
24	Aircraft and position paths for IVY, MIKE.	185

ILLUSTRATIONS (continued)

<u>Figure</u>		<u>Page</u>
25	Radex areas, project instrumentation locations, and positions of task force ships, IVY, KING.	201
26	Aircraft positions and paths for IVY, KING.	203
27	IVY, KING cloud viewed from Japtan.	205
28	Estimate of IVY maximum exposure due to secondary fallout with no shielding and no weathering at Enewetak base islands.	256

TABLES

<u>Table</u>	<u>Page</u>	
1	IVY detonations, Enewetak, 1952.	17
2	Strength of Task Group 132.2 as of 1 August 1951.	42
3	Headquarters, JTF 132 staffing for IVY.	45
4	Planned Task Group 132.1 staffing for IVY.	46
5	Task Group 132.2 manning levels and locations as of 8 October 1952, IVY.	48
6	Monthly personnel totals for Task Group 132.2, IVY.	49
7	Arrival of components of Task Group 132.3 in the forward area, IVY.	50
8	Task Group 132.3 strength during IVY.	51
9	Planned buildup of Task Group 132.4 in the forward area, IVY.	52
10	Actual buildup of Task Group 132.4 in the forward area, IVY.	54
11	Expected distribution of task force personnel, October 1952.	55
12	Elements and functions of Task Group 132.3, IVY.	61
13	Radiological safety personnel support requested by Commander, Task Group 132.1, IVY.	69
14	Radiological safety course attendees, IVY.	79
15	Task Group 132.3 allowance for radiac equipment, IVY.	92
16	Sources of Task Group 132.1 personnel, IVY.	119
17	Islands of Enewetak Atoll, their distances from surface zero, their radiation environment, and planned IVY, MIKE recovery missions.	123
18	Planned schedule for IVY, MIKE recovery missions.	124
19	IVY personnel exposures, Task Group 132.1.	126
20	IVY, KING radiation levels and planned reentry missions.	129
21	Details of planned IVY, KING recovery missions.	130
22	Air Force mission aircraft participation for IVY, MIKE.	186
23	Lagoon contamination, IVY, MIKE.	193
24	Secondary fallout on gummed paper collectors, IVY, MIKE.	197
25	Mission aircraft participating in IVY, KING.	207
26	IVY personnel exposure, U.S. Army organizations.	210

TABLES (continued)

<u>Table</u>		<u>Page</u>
27	Naval personnel in IVY.	215
28	IVY personnel exposure, U.S. Navy organizations.	217
29	Task Group 132.3 ship and aircraft scientific project support, Operation IVY.	222
30	Operation IVY, Task Group 132.3 arrivals and departures, Pacific Proving Ground.	235
31	Air Force personnel badged for IVY and task group assignment.	240
32	IVY personnel exposure, U.S. Air Force organizations.	243
33	IVY personnel exposure, U.S. Marine Corps organizations.	249
34	IVY personnel exposure, joint defense, AEC, other government agencies, and contractor organizations.	251
35	Summary of IVY personnel exposure by service.	258
36	Summary of IVY personnel exposure by task force organization.	259

CHAPTER 1
OVERVIEW

INTRODUCTION

Purpose

IVY was a test series in which two nuclear devices were detonated at the Atomic Energy Commission's (AEC) Pacific Proving Ground (PPG) at Enewetak* Atoll in the fall of 1952. Table 1 lists the detonations.

Table 1. IVY detonations, Enewetak, 1952.

Assigned Name	Local Date	Location	Yield ^a
MIKE	1 Nov	Eluklab Island; surface	10.4 MT
KING	16 Nov	Airburst (1,480 feet [440 meters]) over reef off Runit Island;	500 KT

Note:

^aOne kiloton equals the approximate energy release of the explosion of one thousand tons of TNT; one megaton equals the approximate energy release of the explosion of one million tons of TNT.

This report documents the participation of Department of Defense (DOD) personnel in this test series. Its purpose is to bring together the available information about this atmospheric nuclear test series pertinent to the radiation exposure of DOD personnel, both uniformed and civilian employees. The report lists the DOD organizations represented and describes their activities. It discusses the potential radiation exposure involved in these activities and the measures taken for the protection of DOD personnel. It presents the exposures recorded by the participating DOD units.

* A better understanding of the Marshall Islands language has permitted a more accurate transliteration of Marshall Islands names into English language spelling. These newer transliterations are used in this report with few exceptions. Appendix A is a list of the names and their variant spellings.

Historical Background

The two detonations of the IVY series were MIKE and KING. MIKE was the first nuclear fusion device. Although the novelty of the experiment made yield prediction difficult, the device designers expected a yield of at least 4 MT and perhaps as much as 10 MT, assuming a fusion reaction could be triggered. Even at the lower yield, MIKE would be by far the most powerful nuclear device ever detonated. The yield for KING, an airdropped weapon, was predicted to be about 500 KT, making it the most powerful fission weapon ever detonated. Consequently, planning for both shots was dominated by concern to avoid injury to task force personnel and damage to the PPG's main camps on Enewetak and Parry islands by the huge blasts, their thermal effects, and the resulting fallout. For MIKE, only evacuation of the entire atoll seemed to offer an adequate margin of safety.

The test program for Operation IVY was the result not only of scientific and technical considerations, but also of an intense controversy within the elements of the U.S. Government concerned with foreign policy and defense matters. The successful explosion of the first Soviet nuclear device in the fall of 1949 was extremely unsettling to many in the United States, even though nuclear scientists had predicted in 1945 that an energetic Soviet effort to develop nuclear weapons might well bear first fruit within 4 to 6 years.

Various plans to meet the challenge of the Soviet detonation rapidly evolved. Most called for stepped-up development and production of fission weapons and the required delivery systems. One plan called for the development of fusion, or thermonuclear, weapons with vastly greater explosive power. Opponents of fusion weapons argued that the Soviets could be persuaded not to develop these weapons if the United States would refrain. They further argued that such weapons were not much more effective than high-yield fission weapons. Finally, they argued that given the dynamism of the U.S. nuclear program, the Soviets could be quickly overtaken if they pushed ahead with fusion weapons.

The advocates of fusion weapons won the dispute, and MIKE became the centerpiece of Operation IVY and the proof test of the new concept. Nevertheless, KING represented a test of the kind of high-yield fission weapon some of the fusion opponents had in mind. To a degree, the KING weapon also offered a

backup to help ease the national sense of vulnerability, if the initial attempt at a fusion reaction detonation was unsuccessful (Reference D.3, pp. 106 and 111).

Report Organization

Subsequent sections of this chapter discuss the form of experimental nuclear weapon test programs with emphasis on the potential radiation exposure of participating DOD personnel. The experimental activities are considered first, without particular reference to the geographic location of the testing, and are then related to the geographic limitations on such activities at the PPG. The portion of the experimental program with heaviest DOD participation is emphasized. The chapter concludes with a description of Joint Task Force 132 (JTF 132), the organization that conducted Operation IVY, and indicates how the DOD elements within JTF 132 functioned.

Chapter 2 is concerned with the radiological safety (radsafe) aspects of the tests. It documents the procedures, training, and equipment used to protect participants from the radiation exposure potential inherent in the test operations.

Chapter 3 focuses on the role of the DOD in the experimental program of IVY in general, leading to a discussion of the DOD operations for the two test events in particular. Chapter 4 is a narrative discussion of the operations that took place during these events.

Chapters 5 through 8 summarize participation by the Army, Navy, Air Force, and Marine Corps. Chapter 9 summarizes the participation of other government agencies and contractors. A listing of participating units and a statistical characterization of their personnel exposures are included in these chapters. The personnel exposures are discussed in Chapter 10.

NUCLEAR TESTS AND RADIATION EXPOSURES

Nuclear testing before 1963 consisted mostly of the unconfined detonation of nuclear devices in the atmosphere. The devices might be placed on a platform or a barge on the surface, placed atop a tower, supported by a balloon, dropped from an airplane, or flown on a rocket. A few were detonated underwater or buried in the earth or in underground tunnels and shafts.

In theory, personnel could be exposed either by the radiation emitted at the time of explosion and for about 1 minute thereafter -- usually referred to as initial radiation -- or the radiation emitted later (residual radiation). In practice, however, there was no involuntary, direct exposure of personnel to initial radiation during testing. This is part of the violent nuclear explosion process itself, and to be close enough for initial radiation exposure would place an observer within the area swept by lethal blast and thermal effects.

The neutron component of initial radiation did indirectly contribute to the possibility of personnel exposure. Neutrons are emitted in large numbers by nuclear weapon explosions. They have the property of altering certain non-radioactive materials so that they become radioactive. This process, called activation, works on some forms of sodium, silicon, calcium, manganese, and iron, as well as other common materials. Activation products thus formed are added to the inventory of the radioactive products produced in the explosion process. The radiation emitted by this inventory more than 1 minute after detonation is referred to as residual radiation.

The potential for personnel exposure to residual radiation was much greater than the potential for exposure to initial radiation. In the nuclear explosion process, fissioning atoms of the heavy elements, uranium and plutonium, split into lighter elements, releasing energy. These lighter atoms are themselves radioactive and decay, forming another generation of descendants from the original fissions. This process is rapid immediately after the explosion but slows later and continues for years at very low levels of radioactivity.

Overall radioactivity of all the fission products formed decays at a rate that is closely approximated by a rule that states that for each sevenfold increase in time, the intensity of the radiation will decrease by a factor of

ten. Thus, a radiation rate of 1 roentgen per hour (R/hr) at 1 hour after the detonation would be expected to be 0.1 R/hr after 7 hours and 0.01 R/hr after 49 hours. This rule seems to be valid for about 6 months following an explosion, after which the observed decay is somewhat faster than that predicted by this relationship. Activation products, in general, decay at a faster rate than the fission products.

Fission products and activation products, along with unfissioned uranium or plutonium from the device, are the components of the radioactive material in the debris cloud, and this cloud and its fallout are the primary sources of the potential exposure to residual radiation.

In a nuclear airburst in which the central core of intensely hot material, or fireball, does not touch the surface, the device residues (including the fission products, the activation products resulting from neutron interaction with device materials, and unfissioned uranium and/or plutonium) are vaporized. These vapors condense as the fireball rises and cools, and the particles formed by the condensation are small and smoke-like. They are carried up with the cloud to the altitude at which its rise stops, usually called the cloud stabilization altitude. Spread of this material then depends on the winds and weather. If the detonation size is small, the cloud stabilization altitude will be in the lower atmosphere and the material will act like dust and return to the Earth's surface in a matter of weeks. Essentially all debris from detonations with yields equivalent to kilotons of TNT will be down within 2 months (Reference A.6). Areas in which this fallout material will be deposited will appear on maps as bands following the wind's direction. Larger detonations (yields equivalent to megatons of TNT) will have cloud stabilization altitudes in the stratosphere (above about 10 miles [16 km] in the tropics); the radioactive material from such altitudes will not return to Earth for many months and its distribution will be much wider. Thus, airbursts contribute little potential for radiation exposure to personnel at the testing area, although there may be some residual and short-lived radiation coming from activated surface materials under the burst if the burst altitude is sufficiently low for neutrons to reach the surface.

Surface and near-surface bursts pose larger potential radiation exposure problems. These detonations create more radioactive debris because more material is available for activation within range of the neutrons generated by the explosion. In such explosions the extreme heat vaporizes device materials and activated Earth materials as well. These materials cool in the presence of additional material gouged out of the burst crater. This extra material causes the particles formed as the fireball cools to be larger in size, with radioactivity embedded in them or coating their surfaces. The rising cloud will lift these particles to altitudes that will depend on the particle size and shape and the power of the rising air currents in the cloud, which in turn depend on the yield of the detonation. The largest particles will fall back into the crater or very near the burst area with the next largest falling nearby. It has been estimated that as much as 80 percent of the radioactive debris from a land-surface burst falls out within the first day following the burst (Reference A.6).

Bursts on the surface of the seawater generate particles consisting mainly of salt and water drops that are smaller and lighter than the fallout particles from a land-surface burst. As a consequence, water-surface bursts produce less early fallout than similar devices detonated on land. Large-yield surface bursts in the PPG over relatively shallow lagoon waters or on very little truly dry land probably formed a complex combination of land-surface- and water-surface-burst particle-size characteristics.

EXPERIMENTAL PROGRAM

Central to the test series was the experimental program. This program and its requirements dictated the form of the test organization and the detail of personnel participation. Like most of the preceding nuclear test series, IVY's experimental program incorporated two aspects, the most important of which were the diagnostic measurements of the devices; the secondary experiments involved the measurement of the explosive and radiation effects.

These two aspects can serve as a rough measure of differentiation of interest between the major participants: the AEC interest in weapon development, and the DOD interest in the military application of the effects of the explosions. In IVY, however, the AEC was still sponsoring experiments in areas

that later became of DOD interest exclusively. These were measurements of airblast and thermal radiation, for example, that were termed "field variable" measurements (Reference C.1.2, Jan Inst). These measurements were used to construct the hostile environment for studies of the response of military systems and have been termed "environmental measurements" in this report.

The several parts of the weapon development and the effects studies each had particular features that led to the possibility of radiation exposure.

Weapon Development

In testing devices, weapon designers are interested in two classes of measurements: the total energy release of the device, and the rate of release. Total energy release measurements are called yield measurements, and the rate of release measurements are called diagnostic measurements.

YIELD MEASUREMENTS. Device yield is usually determined by several methods, two of which involve photo-optical techniques. Growth of the intensely hot and radiating mass of device debris and air that constitute the nuclear fireball varies with its yield. Very-high-speed cameras were therefore used to record this growth, and film records subsequently analyzed to infer yield. Duration and intensity of the energy pulse in the optical-thermal spectral region also vary with yield; thus, light detectors coupled to recorders were also used to derive yield.

In addition, yield may be determined by collecting and analyzing a representative sample of the device debris. Inferences are then drawn regarding the yield, based on knowledge of the materials in the device.

Construction, instrumentation placement, and data recovery for the photo-optical yield determinations did not usually require personnel to be in areas with a high potential for exposure to radiation. Cameras and light detectors need only a clear field of view of the burst point and enough breadth of view to encompass the fireball. Camera placement did not involve personnel activities at times and places of high radiation levels. Film recovery generally did not involve high exposure potential, as the photo stations were usually at ranges and in directions not heavily contaminated by fallout.

Sampling of device debris, however, necessitated much closer contact with higher levels of radioactivity. The technique used in IVY and most atmospheric tests was to fly aircraft with collectors directly through portions of the radioactive (or "mushroom") cloud, although for some shots during some tests, rockets and drone aircraft were used. About 90 percent of the fission debris was usually considered to be in the upper or cap portion of the mushroom cloud (Reference A.6). Several aircraft were used to obtain a representative sample. Aircrews were exposed to the radiation emitted by the radioactive particles in the cloud as they flew through. Aircraft flying these sampling missions picked up significant amounts of radioactive material on their surfaces, posing additional and continuing radiation exposures to aircrews as they returned to base, as well as to decontamination ground crews. Samples collected were radiologically "hot" and required special handling as they were taken from the aircraft and prepared for shipment to the laboratory for analysis.

DIAGNOSTIC MEASUREMENTS. The explosion of a nuclear device is a progressive release of increasing amounts of nuclear radiation, some of which directly escapes the device. The rest of the radiant energy interacts with the associated material of the device itself and is converted into differing forms of radiation and into the kinetic energy of the remaining materials in a small fraction of a second. The intensely hot core then reradiates, heating the surrounding air and creating a shock wave that propagates outward from the burst point.

Weapon diagnosticians used sophisticated techniques to follow the processes that occur during the device explosion. Detectors and collectors were run up to, and sometimes inside, the device case so that the radiation being sampled could be directly channeled some distance away and there be recorded by instrumentation designed to survive the ensuing blast. To enhance its transport, radiation was conducted through pipes (often evacuated or filled with special gases) from the device to stations where recording instrumentation was located or where the information could be retransmitted to a survivable recording station.

Radiation measurements are based upon the effects that result from the interaction of the radiation with matter. Fluorescence is one such effect.

Materials that fluoresce with radiation exposure were placed in view of cameras or light detectors to provide a record of the variation of fluorescent intensity with time, thereby providing an indirect measurement of the radiation environment.

Other methods of detecting radiation involve the shielding (attenuation) properties of Earth materials, water, and other substances. These materials are also used to baffle or collimate radiation to ensure that radiation is directed toward the detecting instrument.

Radiofrequency energy produced by the explosion can be detected by radio receivers and, with the addition of filtering and processing circuitry, can also provide information about the energy flow from the explosion. Such measurements permit remote placement of receiving and recording instruments.

Preshot preparation included the hazards normally associated with heavy construction, laboratory experiments, and recreation. These included the accidental swimming deaths of two sailors, workers bitten by barracuda, coral burn infections, the accidental electrocution of a scientist, and tritium exposure. The residual radioactivity from previous tests had decayed to nonhazardous levels (Reference C.1.7.5).

The potential for radiation exposure of personnel associated with weapon diagnostic experiments depended upon the proximity of the measurement or data recovery point to ground zero and the time lapse between the detonation and the data collection.

The primary radiation exposure potential is from fission* products and materials made radioactive by neutron activation of device and Earth materials in the vicinity of ground zero. Thus, the distance from ground zero is a principal factor in assessing exposure to persons engaged in the experimental program.

* Although MIKE was a thermonuclear, or fusion, device, a significant portion of its energy release resulted from fission processes.

Since radiation decays with time, the time lapse between the explosion and exposure is a critical factor in exposure assessment. Primary recording media for these experiments were photographic films from oscilloscope, streak, or framing cameras located in survivable bunkers near the detonation point. Because radiation fogs film in time, these films and other time-sensitive data were removed from the bunkers by helicopter-borne personnel within hours of the detonation to minimize damage by fogging. This recovery constituted the main potential for exposure of weapon diagnostics participants.

Effects Experiments

Both IVY shots tested new weapon developments. Priorities of time and space and go or no-go considerations favored the weapon development experiments over the effects experiments. Although the effects experiments were clearly secondary, they directly involved a relatively large number of DOD organizations and individuals and are therefore of prime importance for this report.

Effects experiments were intended to acquire urgently needed military data that could not be obtained from the smaller yield tests at the Nevada Proving Ground, now called the Nevada Test Site. These experiments may be classed into two general kinds. The first class of measurements was made to document the hostile environment created by the nuclear detonation. The second class of effects experiments documented the response of systems to the hostile environment; these measurements are termed systems response experiments.

ENVIRONMENTAL MEASUREMENTS. The purpose of environmental effects measurements was to gain a comprehensive view of the hostile environment created by a nuclear detonation to allow military planners to design survivable military hardware and systems and train personnel to survive. Examples of environmental measurements include static (crushing) and dynamic (blast wind) air pressures in the blast wave, heat generated by the detonation, and fallout radiation. Measurement techniques employed for IVY varied with the effect being measured, but usually measuring devices or gauges were placed at a variety of ranges from ground zero and their measurement recorded in some way. A wide variety of gauges and data-recording techniques was used. In some cases, measurements were similar to those being made by the weapon designers,

but at greater distances or longer after the detonation, which simplified the recording of the data, although the recovery problems were by no means trivial.

Rugged, self-recording gauges had been developed for blast and thermal radiation measurements by 1952 so that complete loss of data from a project would not occur if instrument recovery were delayed, for example, by heavy fallout. For nuclear radiation measurements, however, prompt data recovery was still desirable as the gauges used might be thin foils of some material that would be made radioactive by the burst-time neutrons; hence early observation was necessary, before the information contained in the induced radiation pattern decayed away.

The potential for radiation exposure of personnel responsible for environmental measurements in general depended on the proximity of the instruments to the device and the time that elapsed between detonation and instrument recovery, as was the case for weapon development experimentation: the nearer in space or time to the detonation, the greater the potential for exposure.

SYSTEMS RESPONSE EXPERIMENTS. To document the response of systems to the hostile environment, military hardware (such as aircraft or naval mines) was exposed to the effects of nuclear detonations.

The techniques used for the systems response experiments were conceptually simple: exposure of the system of interest and observation of its response. Actual conduct of the experiments was far more complex. The level of the threat to which the system was exposed almost always required documentation so that the response could be properly understood, necessitating an environmental experiment along with the systems response experiment. It was often not enough to know whether the system survived, but rather the response of the component parts and their interactions was required, entailing the placement of sophisticated instrumentation and recording devices.

While the potential radiological exposure for these systems response experiments was governed primarily by the closeness in space or time, an additional problem arose. Often, when the subject of the exposure itself was recovered for closer examination, it might be contaminated by device debris or even be radioactive because of the activating effects of the device's neutron output.

OCEANIC TESTING OPERATIONS

Implications of oceanic testing have only incidentally been remarked upon. These are now discussed, especially as they relate to DOD operations during IVY.

Marshall Islands Setting

The Marshall Islands are in the easternmost part of the area known as Micronesia ("tiny islands"). The Marshalls encompass about 770 thousand mi^2 (2 million km^2) of the Earth's surface, but the total land area is only about 70 mi^2 (180 km^2). Two parallel chains form the islands: Ratak (or Sunrise) to the east, and Ralik (or Sunset) to the west; Enewetak is in the Ralik chain at its northern extremity. Figure 1 shows the Marshalls in the Central Pacific; and Figure 2 is a map of Enewetak Atoll and also shows pre-IVY detonation sites.

A typical atoll, Enewetak is a coral cap set on truncated, submerged volcanic peaks that rise to considerable heights from the ocean floor. Coral and sand have gradually built up narrow islands into a ring-like formation with open ocean on the outside and a relatively sheltered lagoon on the inside. Enewetak has three passages, Southwest Passage, Wide Entrance, and Deep Entrance, that permit access to its lagoon from the sea. All the islands are low-lying, with elevations seldom over 20 feet (6 meters) above high tide.

Elliptically shaped, Enewetak is approximately 550 nmi (1,020 km) southwest of Wake Island and 2,380 nmi (4,410 km) southwest of Honolulu. It encloses a lagoon of 17 by 23 miles (27 by 37 km) and has a total land area of 2.75 mi^2 (7.12 km^2), with elevations averaging 10 feet (3 meters) above mean sea level. The support section of Enewetak (Enewetak, Parry, and Japtan islands) constitutes about 34 percent of the atoll's land surface. The string of islands from Runit to Bokoluo, the detonation area, constitutes about 32 percent. The various names used for the islands of the atoll are listed in Appendix A, "Island Synonyms."

The climate of Enewetak is tropical marine, generally warm and humid. Temperature changes are slight, ranging from 70^o to 90^oF (21^o to 32^oC). Rainfall is moderate, and prolonged droughts may occur. North of Enewetak is open

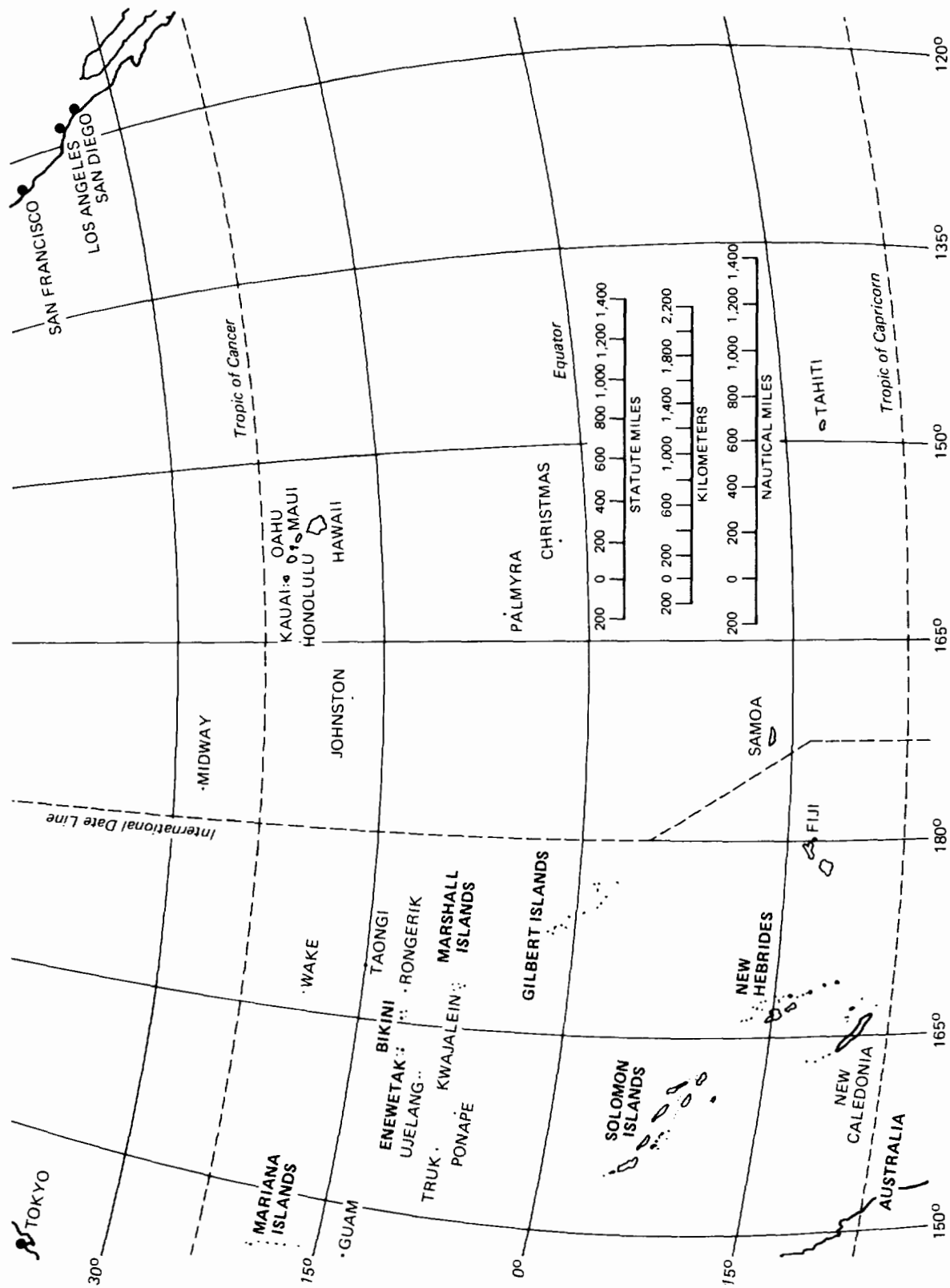

Figure 1. The Central Pacific.

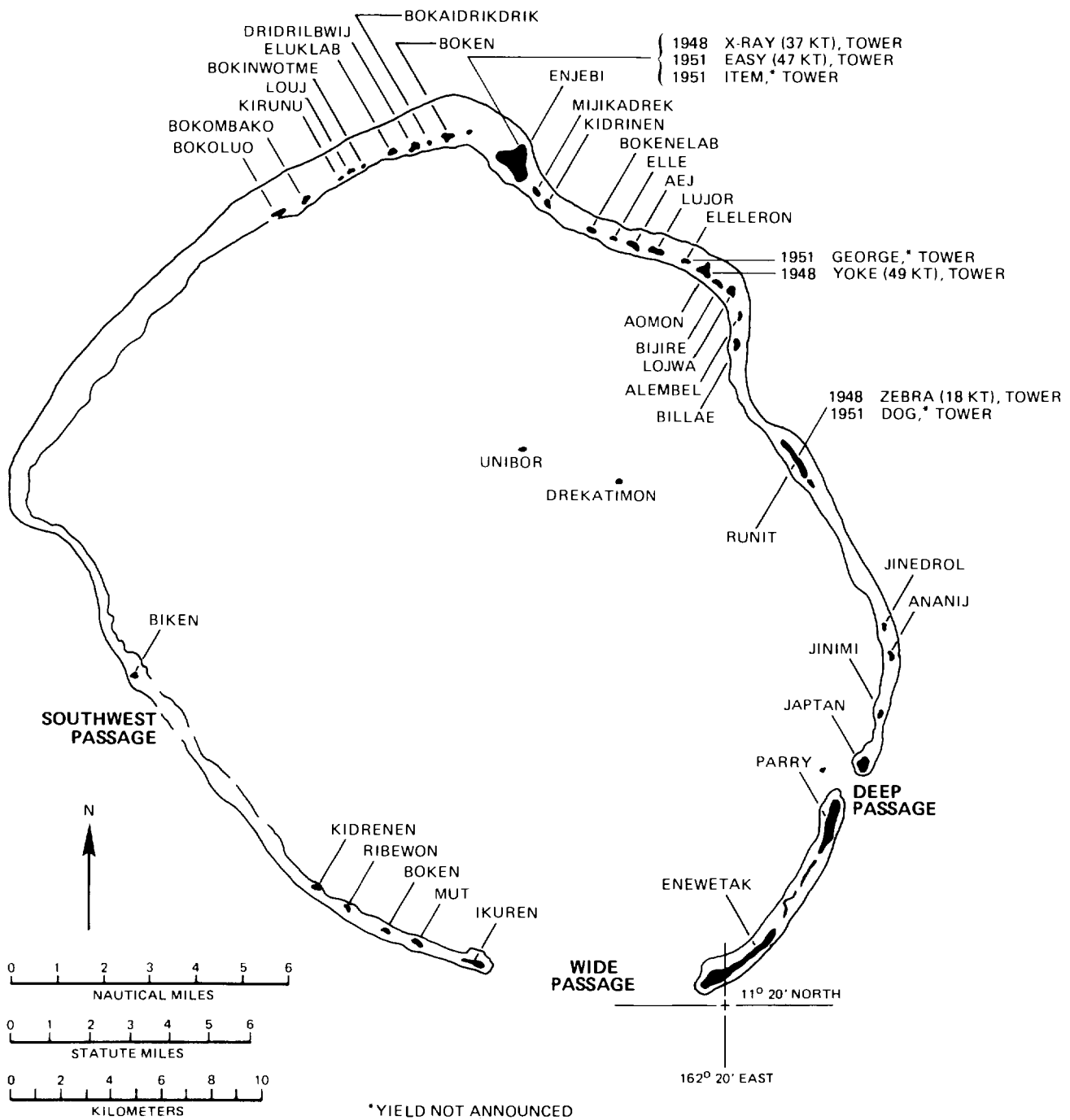

Figure 2. Enewetak Atoll, 1952, with pre-IVY test sites.

ocean for a thousand miles, with the only inhabited island being Wake. Storms are infrequent, although typhoons occur; nevertheless, both wind and sea are continuous erosional agents. Although possible at any time, most tropical storms occur from September to December. Much cumulus cloud cover exists in the area.

The Enewetak region incorporates three basic wind systems. The northeast trade winds extend from the surface to 25,000 or 30,000 feet (7.6 or 9.1 km), the upper westerlies from the top of the trades to the base of the tropopause at 55,000 to 60,000 feet (16.8 to 18.3 km), and the Krakatoa easterlies from the tropopause into the stratosphere. These systems are all basically east-to-west or west-to-east currents. Day-to-day changes reflect the relatively small north-south components, which are markedly variable. Greatest variation occurs in the upper westerlies, particularly during late summer and fall.

The steady northeast trade winds in the lower levels cause the water at the surface of the lagoon to flow from northeast to southwest, where it sinks to the bottom and returns along the lower levels of the lagoon, rises to the surface along the eastern arc of the reefs and islands, and is moved by the winds to the southwest again. The lagoon waters moving in this closed loop also mix with those of the open ocean, resulting in a flushing action. The flushing is rapid and has two major routes. The first is directly through the eastern reefs to the western reefs; the second is through Deep Entrance between Japtan and Parry and out Wide Entrance west of Enewetak. These two routes also function to keep the waters of the northern part of the lagoon separate from the southern waters.

Land areas of Enewetak and Bikini Atolls, their lagoons, and the waters within 3 miles (5 km) of their seaward sides constituted the PPG.* These islands are part of the Trust Territory of the Pacific Islands, a strategic area trusteeship of the United Nations, administered by the United States. The U.S. agency in charge of the PPG itself was the AEC.

* After 1956, the PPG was designated the Eniwetok Proving Ground, or EPG.

The Test Division of the AEC Division of Military Applications, Santa Fe Operations Office, administered the test site through its Enewetak Branch Office, which supervised engineering, construction, maintenance, operation, and management activities performed by its contractor, Holmes & Narver, Inc. (H&N).

PHYSICAL CONDITIONS IN 1952. Enewetak had been the site of nuclear testing in 1948 and 1951: the islands in the southeast quadrant served as the base for the task forces, and the islands from north through east-northeast were used for the tests themselves. The principal base islands were Enewetak, which bordered Wide Entrance, and Parry, northeast of Enewetak, which bordered Deep Entrance. These two islands account for about 30 percent of the atoll's land area.

The following facilities had been constructed on Enewetak Island by mid-October 1950 (Reference D.2, pp. 149-150):

- One hundred thirty-six buildings with floor space totaling about 403,000 ft² (37,440 m²)
- An airfield with a 7,000-foot (2,134-meter) runway and 58.4 acres (23.6 hectares) of taxiways and parking areas
- Paved roads totaling 5.38 miles (8.66 km)
- Three piers
- Utilities, including sewers, salt- and freshwater systems, a telephone system, and a 3,000-kW electric power system.

In the northeastern arc of the atoll, causeways and temporary camps had been built for use in the two previous test series. The islands of Aomon and Bijire had been joined by a causeway for SANDSTONE (1948), and the causeway had been extended from Eleleron to Lojwa for GREENHOUSE.

The northern and eastern islands involved in the shot or shot-support activities had been graded extensively. But Japtan, lying just across Deep Entrance from Parry, still contained a considerable stand of coconut palms and other vegetation.

RADIOLOGICAL CONDITIONS IN 1952. SANDSTONE detonations on Enjebi, Aomon, and Runit left portions of these islands radioactive. Figure 2 shows these detonation sites. In October 1948, an H&N reconnaissance party described an

area of ground with a radius of about 1,000 feet (305 meters) centered on the location of each shot tower. Radioactivity within each area would have resulted in exposure beyond the then accepted daily limit of 0.1 R. Apparently, at some time after the major preparations for GREENHOUSE began, these areas were covered with uncontaminated soil (Reference D.2, p. 42).

GREENHOUSE detonations were on Enjebi, Eleleron, and Runit (see Figure 2) and left these islands and other areas contaminated. DOG and ITEM tower residues were left in place on Enjebi after GREENHOUSE. Information, however, is lacking on the exact extent of the radiation area. Entry onto Enjebi, Mijikadrek, Eleleron, and Runit was controlled by the AEC through 31 October 1951 (Reference C.2.3, First Installment, p. 9). Enjebi was still considered "quite hot" in March 1953 (possibly from further contamination by MIKE), although the GREENHOUSE surface zeroes would have contributed localized hot spots that could potentially lead to radiation exposures to personnel working on these islands during the IVY preparations.

Shot GEORGE of GREENHOUSE (1951) left a large crater on Eleleron. In February 1953, readings, primarily from the crater, were between 0.050 and 0.095 R/hr, with little, if any, contribution from the IVY (1952) shots. These readings would have been higher in 1952 during the preparations for and execution of IVY. IVY preparations focused on the MIKE experiments, which were concentrated on the islands from Boken west, as the zero point was on Eluklab. Some projects, however, had instrumentation sites on Enjebi, Eleleron, and Runit. The reef just north of Runit was also the surface zero for KING, and the island was heavily instrumented. Some exposure to residual radiation from the GREENHOUSE tests obviously occurred, but as these areas were controlled such exposures would have been reflected in the film badge listings in the Consolidated List (Reference C.1.7.2).

Special Problems in Oceanic Testing

Enewetak Atoll and its surrounding waters offered a relatively isolated area for nuclear testing and for the favorable disposition of test debris if the winds were in the right direction. The very limited land area, however, presented problems for the test program. Space for housing test personnel and for storage of supplies was at a premium. Wind direction dictated that testing

be conducted on the atoll's northern islands. Conveniently, Enewetak and Parry, two of the three largest islands, were located in the atoll's south-eastern quadrant. Two major camps were built on them to house the portion (approximately 40 percent) of the task force at Enewetak Atoll not afloat. But Enewetak, the largest island, had only about 320 acres (130 hectares) and half of this area was used for an airstrip and its related facilities.

The smaller northern islands were not arranged in a pattern that facilitated the placement of instruments, so various actions had to be taken to meet the requirements of the IVY experimental program. A causeway about 9,000 feet (2,800 meters) long was built from Eluklab across Dridrilbwiij and Bokaidrikdrik to Boken. The causeway provided a road between ground zero on Eluklab, the temporary support camp on Dridrilbwiij, and major scientific stations on Boken. It also supported a plywood, helium-filled conduit (the Krause-Ogle Box) extending from the MIKE cab (the structure housing the device) to the scientific stations on Boken and carried coaxial cable leading from the cab. Figure 3 shows a load of fill being dumped during the construction of the causeway, and Figure 4 shows the view down the causeway from Boken looking toward the MIKE detonation point.

Floating data-collection stations helped compensate for the lack of appropriately located land. Fallout stations were mounted on twenty 60-man life floats anchored in the atoll's lagoon. In addition, fallout stations were mounted on 10 task force ships, USS Curtiss (AV-4), USS Estes (AGC-12), USS Leo (AKA-20), USS Oak Hill (LSD-7), USS Agawam (AOG-6), USS Carpenter (DDE-825), USS Fletcher (DDE-445), USS Radford (DDE-446), USS O'Bannon (DDE-450), and USS Rendova (CVE-114). Fallout stations were also mounted on 19 dan buoys that were placed in a pie-slice pattern eastward from the atoll.

The testing process used up much of the limited land space that was available. An extreme case was the IVY, MIKE shot, which eliminated Eluklab, the island on which the device was detonated, and left a large underwater crater.

Finally, Enewetak Atoll was not sufficiently large to permit detonation of a device of MIKE's yield without significant risk of blast damage or radioactive contamination of the main camps on Enewetak and Parry islands. Evacuation of Enewetak Atoll was no small task, so Ujelang Atoll and, especially, Bikini Atoll, were considered as alternative sites for MIKE.

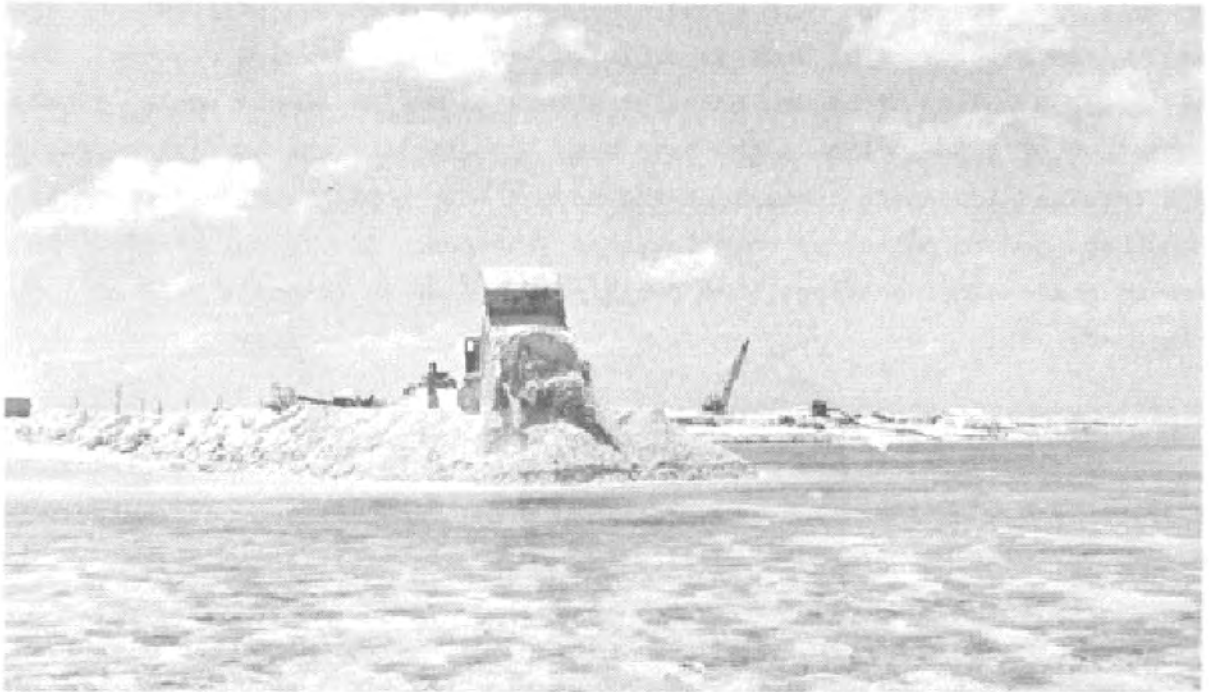

Figure 3. Causeway construction, IVY, MIKE.



Figure 4. Looking down causeway toward IVY, MIKE ground zero.

Detailed study revealed, however, that little would have been gained by use of either location. Both would have required extensive preparation, virtually from scratch -- at best an expensive and time-consuming process. Given very tight supplies of needed materials, such as marine signal cable, timely completion of construction might have been impossible. Use of Ujelang would have required long-term removal of the Marshallese population, and probably would have led to political complications (Reference C.0.1, pp. 49-50). In view of these considerations, the decision was made to detonate MIKE at Enewetak.

JOINT TASK FORCE 132

Successive joint task forces conducted the U.S. nuclear test series in the Pacific. These organizations incorporated elements of the armed services, other government agencies (especially the AEC), and civilian contractors. JTF 132 was the successor to JTF 3, which conducted GREENHOUSE in 1951.

Before IVY, each task force was deactivated after its test series was finished. The AEC continued to develop weapons, but the continuity of testing operations in the Pacific and of the DOD role in those operations was broken after each series. This was inefficient for several reasons: (1) facilities in the PPG were not adequately maintained; (2) military personnel experienced in nuclear testing or the support thereof were assigned to other duties and their skills lost to later stages of the program; (3) planning was interrupted, leading to the need to re-solve previously solved problems as preparations for the next series began; and (4) aircraft and ships modified for nuclear test operations were returned to their previous configuration and put back in the general inventory.

By May 1951 at least two sets of factors were increasing the pressure for a new organizational structure for conducting nuclear tests in the Pacific. First, the international situation and the quickening pace of work in the AEC laboratories indicated that test series might be more frequent in the future; and second, the approaching conclusion of the GREENHOUSE Series raised the question of the disposition of the human and material assets of JTF 3. If, as appeared increasingly probable, the next Pacific test series would involve a fusion device, then a whole new set of problems would be presented because of the anticipated very high yield.

Of course, a new joint task force was one possible solution to the organizational problem, but other ideas were on the table. The interested parties, including the AEC, the Joint Chiefs of Staff (JCS), the Armed Forces Special Weapons Project (AFSWP), and senior officials of the four services considered the problem at length. Although a new joint task force for each series would be inefficient, JTF 3 was too large and expensive for long-term operation, and some believed that military requirements for future Pacific tests would be smaller. In the end, a new joint task force was established, absorbing key personnel from JTF 3 and taking control of U.S. forces rolling up Operation GREENHOUSE at Enewetak. The organization, JTF 132, was activated in Washington, D.C., on 9 July 1951.

The Commander JTF 132 (CJTF 132) reported to the JCS through the Army Chief of Staff. As the command of the permanent task force rotated among the services, the reporting channel rotated in the same sequence. The joint task force also was a subordinate command of the Commander in Chief Pacific (CINCPAC), who provided overall security and logistics support.

Charged with responsibility for nuclear energy development by the Atomic Energy Act of 1946, the AEC designated CJTF 132 as its representative during the operational period of the test series. Thus, the commander had the authority to conduct the tests without the AEC relinquishing its responsibilities under the law.

For IVY, the task force was composed of four task groups: Task Group (TG) 132.1 (AEC scientific activities and base facilities), TG 132.2 (Army), TG 132.3 (Navy), and TG 132.4 (Air Force). All task groups supported the experimental program in one way or another. The organization of JTF 132 and its relationship to higher authority are depicted in Figure 5. The functions of the four task groups are described subsequently.

Pre-IVY Period

After its activation on 9 July 1951, JTF 132 moved quickly to prepare for IVY, the next test series, and to lay a comprehensive base for Pacific testing over the long term.

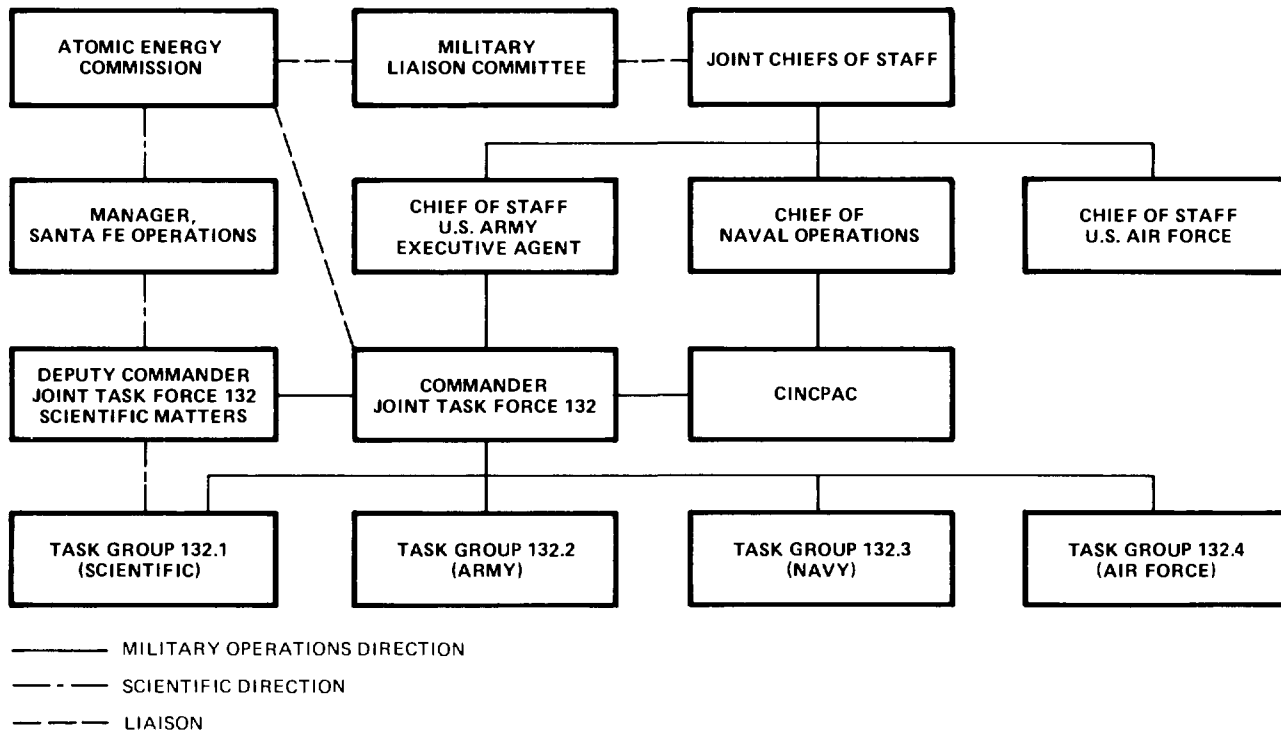

Figure 5. Organization of Joint Task Force 132.

Personnel of TG 3.1, the GREENHOUSE scientific task group, returned to their Los Alamos and Livermore laboratories to analyze the data collected. TG 132.1, the scientific task group for JTF 132, was activated on 2 January 1952 (Reference B.0.4, p. 1). Shortly after activation, the task group commander told members of the task force staff that November 1952 should be used as the planning date for the MIKE shot (Reference C.0.1, pp. 34-35).

MILITARY AT THE PACIFIC PROVING GROUND. By 20 June 1951, after the last test of the GREENHOUSE series, only a military garrison and H&N maintenance personnel remained on Enewetak Atoll (Reference D.2, pp. 164-165). The garrison was largely made up of Army personnel and retained the designation of TG 3.2, the Army task group during Operation GREENHOUSE. On 1 August 1951 TG 3.2 was deactivated and reactivated as TG 132.2. The task group commander represented the CJTF 132 at Enewetak and had operational control of all joint task force elements present. The task group commander also was Commander Enewetak Atoll, reporting to CINCPAC.

TG 3.3 was disbanded completely at the end of GREENHOUSE, although a small naval detachment remained as the boat pool at Enewetak under the operational control of Commander TG 132.2 (CTG 132.2), and a naval deputy was on the staff for the joint task force.

After GREENHOUSE, TG 3.4 was deactivated, but an Air Force detachment remained at Enewetak Island to operate the airfield under the operational control of CTG 132.2. On 19 June 1951, this unit was designated 4931st Test Support Squadron. At the same time the 4930th Test Support Group was established at Kirtland AFB under Special Weapons Command as a cadre for future Air Force activities in the PPG (Reference C.0.1, p. 38).

When TG 3.2 was redesignated TG 132.2 of JTF 132, it consisted of the following units (Reference C.2.3, First Installment, p. 12):

- 7126th Army Unit
- 4931st Test Support Squadron (Air Force), in turn supported by the 1500th Air Transportation Group, Detachment 1500-1 (Military Air Transport Service), the 1960th Airways and Air Communications Squadron, Detachment 1960-1, and the 31st Weather Squadron, Detachment 31-1
- Navy Boat Pool Detachment.

In addition, a small Coast Guard detachment that ran the Loran system station on Enewetak Island was attached to TG 132.2 for base facilities support (Reference C.2.2, p. IV-2).

During the summer of 1951, the garrison force put much effort into cocooning and storing equipment left behind by JTF 3. At the time, it was believed that the next Pacific test series would be held in the spring of 1952, with the buildup beginning in the fall of 1951. When it became clear that a spring series was unlikely, much equipment had to be reprocessed for long-term storage. This task was largely completed in the fall of 1951 (Reference C.0.1, p. 20).

On 16 August 1951, CJTF 132 visited the garrison. Because the size and mission of TG 3.2 had fluctuated widely in the previous 2 years, TG 132.2 had inherited a hodgepodge of orders and directives. CJTF 132 decided a unified operational directive was required, and the result was Operation Order 1-51,

dated 26 November 1951 (Reference B.0.3). Under this order, CTG 132.2 was responsible to CJTF 132 for:

1. Organizing all Army, Navy, and Air Force personnel under his command in a manner best suited to accomplish his assigned mission
2. Maintaining all active military equipment on the atoll in a state of repair and readiness
3. Maintaining all stored military equipment in protective cover as required for minimal deterioration
4. Shipping all surplus equipment and materiel in accordance with instructions from CJTF 132
5. Operating port and stevedoring facilities on Enewetak Atoll in coordination with the AEC contractor, H&N
6. Providing atoll surface and air transportation within the atoll area
7. Maintaining minimum airbase facilities consisting of
 - a. Airbase headquarters
 - b. Airbase operations
 - c. Air Force supply
 - d. Communication and control tower facilities
 - e. Weather observation and forecasting facilities
 - f. Military Air Transport Service (MATS) turnaround station and air passenger and freight terminal facilities
8. Providing for the radiological safety of task force units and visiting military personnel
9. Maintaining and operating the signal communications system on Enewetak
10. Organizing, training, and equipping a combat-type unit
11. Conducting a training program as prescribed in training memoranda of Headquarters JTF 132
12. Preparing a natural disaster plan for use in the event of a typhoon or tidal wave
13. Preparing emergency plans to include the defense of the atoll
14. Supplying and supporting all authorized tenant units, including the U.S. Coast Guard (Loran) detachment.

As Commander Enewetak Atoll, CTG 132.2 also was responsible to CINCPAC for security of the atoll. This meant maintaining the status of the atoll as a closed area, denying entry into the danger area by unauthorized vessels and

aircraft, denying entry into the atoll by personnel lacking proper clearances, and providing surveillance of the atoll to prevent trespassing, photography, or sample removal by unauthorized persons.

During this period, most of the work of the 7126th Army Unit was done on Enewetak Island, but military police of the unit conducted ground security sweeps of the atoll every 4 days or as directed by CJTF 132 (Reference C.0.1, p. 172). The Navy Boat Pool was used to support the surface security sweeps (Reference C.2.1, pp. xii-4; Reference C.0.1, p. 118). Although TG 132.2 was charged with providing stevedoring services on Enewetak Atoll and the 7126th was the unit with this capability, it appears that H&N did most of the work, and it is doubtful whether personnel from the 7126th did any stevedoring on the shot islands or on Parry (Reference C.2.3, First Installment, p. 28). On at least one occasion, ordnance experts of the 7126th were called to the northern islands of the atoll to deal with World War II shells uncovered during construction operations. The Protestant chaplain of the unit conducted services on Enewetak and Parry islands. A Catholic chaplain arrived at a later date. (Reference C.2.2, p. IV-8).

The mission of the Air Force 4931st Test Support Squadron was to provide air transportation within Enewetak Atoll, maintenance facilities for stored Air Force equipment and supplies, and airbase facilities. The squadron had six L-13 aircraft in commission to provide local transportation. H&N generated most of the air traffic in support of their operations on the atoll's northern islands (Reference C.0.1, pp. 112-113; Reference C.2.3, First Installment, p. 28).

According to the CTG 132.2 Final Report, the strength of TG 132.2 as of 1 August 1951 was 335 personnel, distributed as shown in Table 2. The authorized strength of the 7126th Army Unit was 27 officers, 2 warrant officers, and 290 enlisted men (Reference C.2.1, p. IV-2).

The tour of duty on Enewetak Atoll for members of TG 132.2 was 12 months, although many remained longer because replacements were slow to arrive (Reference C.2.3, First Installment, p. 12).

Table 2. Strength of Task Group 132.2 as of 1 August 1951.

	Officers	Enlisted	Total
Army	18	213	231
Navy	1	16	17
Air Force	10	68	78
Coast Guard	1	8	9

CIVILIANS AT THE PACIFIC PROVING GROUND. The other major group of personnel at the PPG during the early part of the garrison phase were employees of the AEC contractor, H&N. H&N was responsible for providing utilities on Enewetak Island, for maintaining some facilities there, and for all construction, maintenance and base support elsewhere on the atoll. Company personnel, under directives from the AEC, provided rad-safe services for the areas of the atoll other than Enewetak Island until the task force arrived in the proving ground (Reference B.0.4, p. 2).

Buildup

CONSTRUCTION. To prepare for IVY, H&N completed numerous construction projects. These projects can be divided into two broad categories: expendable test facilities, and improvements to permanent camps on Enewetak and Parry islands. Expendable test facilities (Reference C.0.1, pp. 129-135) included several classes of projects:

1. Temporary camps and related support facilities. The focus of activity for MIKE was the ground zero on Eluklab Island. The contractor built the causeway connecting Eluklab, Dridrilbwi, Bokaidrikdik, and Boken islands.
2. Scientific stations. Altogether about 500 scientific stations had to be built or renovated for IVY. Some were quite simple, but some were massive and complex. Most of the stations requiring major construction were located on the islands joined by the causeway. Station 1, the MIKE shot cab, was a large building measuring 88 x 46 x 61 feet (26.8 x 14.0 x 18.6 meters) to the eaves, with elaborate equipment to support and monitor MIKE (see Figure 6). Stretching from the shot cab to Boken Island was Station 204, a helium-filled conduit 8 x 8 x 9,000 feet (2.44 x 2.44 x 2,743 meters), known less formally as the "Krause-Ogle Box." At the Boken end of the Krause-Ogle Box were stations 200 and 202, both of thick reinforced

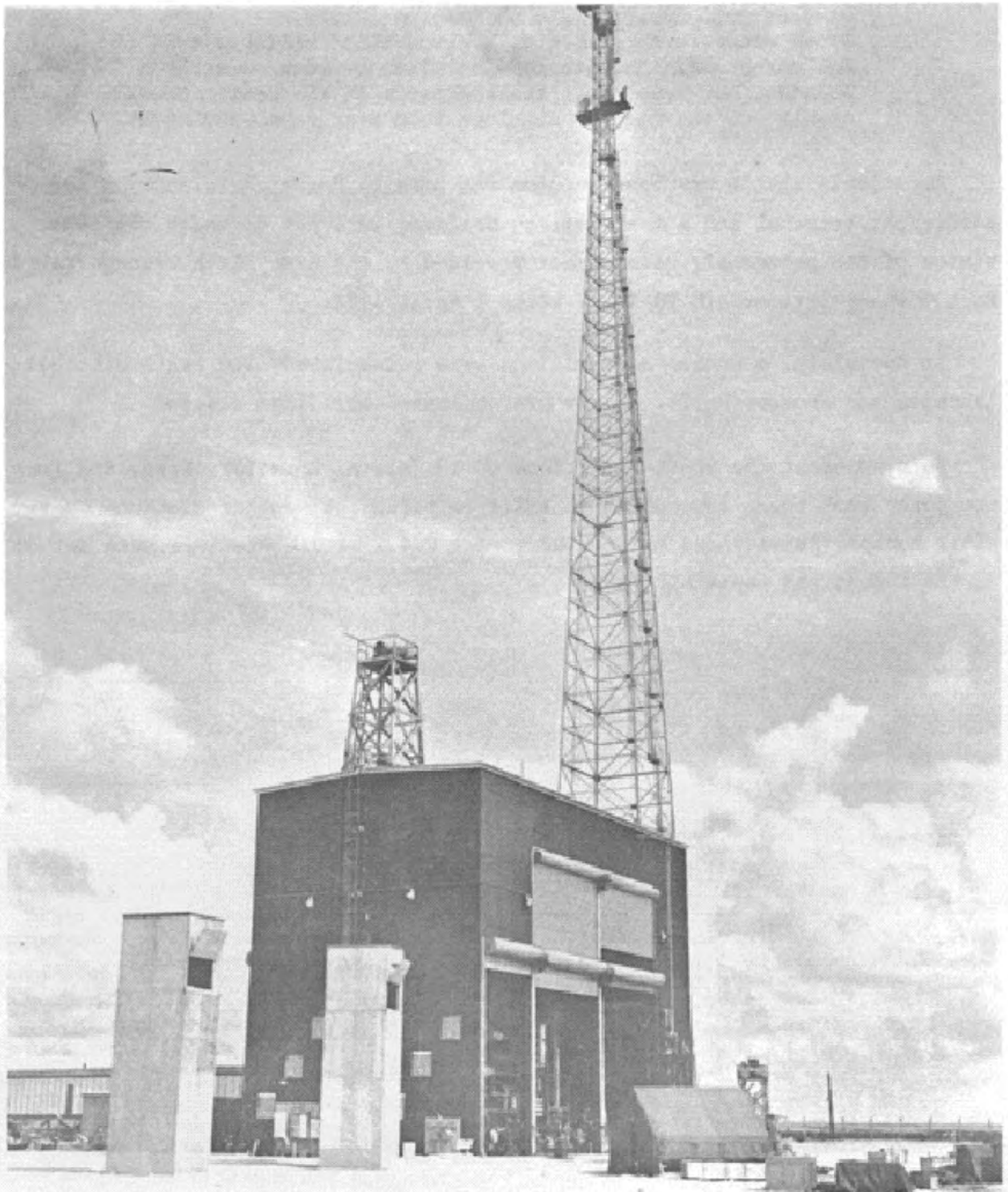

Figure 6. IVY, MIKE cab.

concrete. Figure 7 shows the Krause-Ogle Box entering Station 200. Station 300 on Bokoluo Island was a two-story concrete structure with extra-thick walls to make it fallout-proof. The stations noted above were on various islands, but many small stations were on the reef. Considerable use was made of stations left over from GREENHOUSE.

Relatively little new construction was done on Enewetak Island. A new airfreight terminal and a meat-cutting building were put up under the supervision of H&N personnel, using labor provided by the Army 511th Transportation Port Company attached to TG 132.2 after 1 April 1952.

At Kwajalein, a number of buildings were refurbished, 210 tents erected, latrines and showers built, and 18 prefabricated buildings erected.

To supplement the weather stations on Kwajalein, Enewetak, Wake, and Truk, the joint task force instructed TG 132.4 to establish weather stations on Bikini, Ponape, Kusaie, and Majuro (Reference C.4.1). The stations were set up during August and September 1952.



Figure 7. Krause-Ogle Box at Station 200 on Boken Island, IVY.

BUILDUP OF PERSONNEL AND UNITS. According to task force planning, personnel assigned to task force headquarters were to be in the proving ground by 15 September 1952, with the exception of the small scientific contingent scheduled to be present by 3 October (see Table 3). Most elements of the task group were to be at their posts in the forward area by late October 1952.

Table 3. Headquarters Joint Task Force 132 staffing, IVY.

Service Element	Operational Strength			Operational Location	Date of Arrival in Forward Area
	Officers	Enlisted Men	Civilians		
Army	21	19		Parry	15 Sep 52
Navy	12	12		Parry	15 Sep 52
Air Force	15	19		Parry	15 Sep 52
Scientific	—	—	3	Parry	3 Oct 52
Total	48	50	3		

Source: Reference B.0.2, Change No. 3, p. C-1.

Most, if not all, H&N personnel were assigned either to Test Facilities or Base Facilities Units of TG 132.1. The TG 132.1 population on Enewetak Atoll reached its peak on 24 October 1952 with 556 staff and scientific personnel and 1,129 H&N employees (Reference C.1.1, p. 23). These peak figures are reasonably close to the planned numbers shown in Table 4.

As preparations for IVY proceeded, the authorized strength of the 7126th Army Unit, the core of TG 132.2, was increased to 39 officers, 6 warrant officers, and 441 enlisted men. Several units were added to the task group to help perform its test series missions. The order of their arrival was (Reference C.2.1, p. IV-3):

7131st Army Unit Signal Detachment

First Increment 1 Apr 1952

Second Increment 6 May 1952

511th Transportation Port Company

First Increment 1 Apr 1952

Second Increment 6 May 1952

Table 4. Planned Task Group 132.1 staffing for IVY.

Unit	Operational Strength			Operational Location	Date of Arrival in Forward Area
	Officers	Enlisted Men	Civilians		
Headquarters Task Group 132.1					
Civilian			23	Parry	22 Oct 52
Army	10	20		Parry	22 Oct 52
Navy	5	6		Parry	22 Oct 52
Air Force	6	19		Parry	22 Oct 52
Task Group 132.1 (Scientific Programs)					
	25	24	39	Kwajalein	22 Oct 52
	1	8	5	Bikini	22 Oct 52
			1	Hawaii	22 Oct 52
		3	1	Wake	22 Oct 52
			1	Midway	22 Oct 52
			1	Guam	22 Oct 52
	1	3		Johnston	22 Oct 52
	28	45	239	Parry	22 Oct 52
Task Unit					
132.1.2 (Production)			48	Parry	22 Oct 52
132.1.3 (Special Materials Facilities)			56	Parry	17 Sep 52
132.1.4 (LASL Assembly)	1	1	76	Northern Islands	12 Sep 52
132.1.5 (Sandia Assembly)			6	Kwajalein	12 Nov 52
132.1.6 (Firing Party) ^a				Parry	
132.1.7 (Radsafe)	25	22	5	Parry	29 Oct 52
132.1.8 (Technical Photography)			9	Parry	29 Oct 52
132.1.9 (Documentary Photography)	6	16	2	Kwajalein	22 Oct 52
	5	3	15	Parry	22 Oct 52
132.1.10 (Test Facilities)	1	5		Parry	15 Oct 52
132.1.11 (Base Facilities)		13		Parry	12 Nov 52
Holmes & Narver			789	Parry	In Place
			49	Enewetak	In Place
			428	Northern Islands	In Place
			39	Bikini	In Place
Total	114	188	1,832		

Note:

^aPersonnel drawn from other task units.

Source: Reference B.O.2, Change No. 3, pp. C-1 and C-2.

4th Transportation Truck Company	
First Increment	1 Apr 1952
Second Increment	6 May 1952
Counterintelligence Corps, Provisional, Sub-detachment C	16 Jun 1952
125th Military Police Provost Marshal Detachment	16 Aug 1952
516th Military Police Service Company	19 Aug 1952
Communications Security Detachment 1, 8607th AAU (Army)	19 Aug 1952
18th Military Police Criminal Investigation Division	19 Aug 1952
A group of Army stevedores, electricians, carpenters, mechanics, and officers posted from Hawaii to the proving ground for temporary duty by the Commanding General, U.S. Army, Pacific	Began arriving 9 Sep 1952 and departed by 27 Oct 1952

The Communications Security Detachment and Sub-detachment C of the Counter-intelligence Corps were attached to TG 132.2 for administrative and logistics support only.

Planned manning levels and locations of the elements of TG 132.2 are given in Table 5 as of 8 October 1952, after the Air Force component, the 4931st Test Support Squadron, had been transferred to TG 132.4. Actual monthly totals for the task group, apparently less the Coast Guard Loran station detachment and the three officers and 95 men on temporary duty from Hawaii, were as shown in Table 6.

TG 132.3 was activated in Washington, D.C., on 8 February 1952. Components of the task group arrived in the forward area as shown in Table 7. Total strength during the operational period is shown in Table 8.

TG 132.4 was activated on 2 January 1952 at Kirtland AFB, Albuquerque, New Mexico (Reference B.0.4, p. 2). Planned arrival times and size of the task group elements as of 8 October can be seen from Table 9. Actual buildup (by location) is shown in Table 10.

The Task Force in Place

As of October 1952, Hq JTF 132 expected the task force personnel to be distributed as shown in Table 11.

Table 5. Task Group 132.2 manning levels and locations as of 8 October 1952, IVY.

Unit	Operational Strength		Operational Location
	Officers	Enlisted Men	
Headquarters Task Group 132.2 (7126th AU)	44	446	Enewetak Island
Temporary duty from U.S. Army, Pacific	3	95	Enewetak Island
Navy Boat Pool Detachment	1	24	Enewetak Island
Loran station USCG Detachment	1	8	Enewetak Island
7131st Army Unit Signal Detachment	4	53	Enewetak Island
	2	40	Parry Island
		1	Northern islands
516th Military Police Company	1	50	Enewetak Island
	2	50	Parry Island
	3	61	Northern islands
Communications Security Detachment 1, 8607th AAU	4	31	Enewetak Island ^a
18th Military Police Criminal Investigation Division	1	2	Enewetak Island
Counterintelligence Corps, Provisional, Sub-Detachment C	1	2	Enewetak Island
		2	Parry Island
		3	Northern islands
125th Military Police, Provost Marshal Detachment	2	5	Enewetak Island
511th Transport Port Company	5	155	Enewetak Island
4th Transport Truck Company	3	125	Enewetak Island
Total	77	1,153	

Note:

^aAboard USS Estes (AGC-12).

Source: Reference C.O.2, p. 82.

Table 6. Monthly personnel totals for Task Group 132.2, IVY.

Date	Army		Air Force		Navy		Total
	Officers	Enlisted Men	Officers	Enlisted Men	Officers	Enlisted Men	
1 Sep 51	17	246	12	67	1	18	361
1 Oct 51	20	247	10	65	1	18	361
1 Nov 51	16	218	11	68	1	25	339
1 Dec 51	18	201	11	69	1	40	340
1 Jan 52	19	245	11	84	1	39	399
1 Feb 52	20	275	13	117	1	22	448
1 Mar 52	22	251	14	73	1	25	386
1 Apr 52	36	512	11	70	1	26	656
1 May 52	37	499	22	106	1	27	692
1 Jun 52	46	670	20	129	1	27	893
1 Jul 52	55	757	26	142	1	26	1,007
1 Aug 52	67	1,009	30	193	1	23	1,323
1 Sep 52	67	1,052	30	186	1	26	1,362
1 Oct 52	71	1,043	31	194	1	24	1,364
1 Nov 52	75	1,039	48	288	1	24	1,475

Source: Reference C.2.1, p. IV-2.

Table 7. Arrival of components of Task Group 132.3 in the forward area, IVY.

Date	Ship or Element	Number of Personnel
7 Jul 52	Gasoline tanker <u>USS Agawam</u> (AOG-6)	122
17 Jul 52	Underwater Detection Unit (arrived by air)	21
21 Jul 52	Fuel oil barge YON-146 arrived under tow by <u>USS Moctobi</u> (ATF-105), which left soon thereafter	0
	Boat pool (advance group of 1 officer and 21 enlisted men arrived by air, remainder 30 July)	---
26 Jul 52	Self-propelled gasoline barge YOG-69 arrived under tow by <u>USS Takekuma</u> (ATF-118), which left soon thereafter	0
30 Jul 52	Main body of boat pool arrived on <u>USS Oak Hill</u> (LSD-7) with their boats: 4 aircraft rescue vessels (AVR), 21 mechanized landing craft, 4 large personnel landing craft (LPC(LI)), 5 utility landing craft (LCU)	330
21 Aug 52	Patrol Squadron 2 (VP-2) with 8 P2V-4 patrol and antisubmarine search aircraft and 3 P2V-5 patrol and antisubmarine search aircraft	392
2 Sep 52	Two PBM-5A patrol flying boats belonging to VP-2	
12 Sep 52	Escort destroyer <u>USS Radford</u> (DDE-446)	259
	Escort destroyer <u>USS O'Bannon</u> (DDE-450)	251
	Escort destroyer <u>USS Carpenter</u> (DDE-825)	276 ^a
	Escort destroyer <u>USS Fletcher</u> (DDE-445)	258
	Seaplane tender <u>USS Curtiss</u> (AV-4)	729
	Troop landing ship <u>USS LST-836</u>	566
18 Sep 52	Amphibious force flagship <u>USS Estes</u> (AGC-12)	566
2 Oct 52	Escort aircraft carrier <u>USS Rendova</u> (CVE-114); on board were 6 F4U-5N carrier-based fighters, 4 TBM-3R torpedo bombers converted for transport, and 5 HRS-2 transport helicopters (34 men of Navy Helicopter Squadron [HS-2] detachment provided personnel for 3 HRS-2 helicopters, and 14 men of Marine Component Air Department provided personnel for 2 HRS-2 helicopters)	972 ^b
14 Oct 52	One P2V-4 aircraft from VP-2 ^c	
14 Oct 52	Auxiliary ocean tug <u>MV Horizon</u> , owned and operated by the Scripps Institution of Oceanography as a research ship	40
18 Oct 52	Transport <u>USNS David C. Shanks</u> (T-AP-180)	191
20 Oct 52	Transport <u>USNS General E.T. Collins</u> (T-AP-147)	192
	Fleet ocean tug <u>USS Yuma</u> (ATF-94)	74
	Attack cargo ship <u>USS Leo</u> (AKA-60)	228
	Fleet ocean tug <u>USS Arikara</u> (ATF-98)	80
	Fleet ocean tug <u>USS Lipan</u> (ATF-85)	79
21 Oct 52	Net laying ship <u>USS Elder</u> (AN-20)	49
14 Nov 52	Auxiliary ocean tug <u>MV Spencer C. Baird</u> , owned and operated by Scripps Institution of Oceanography as a research ship (not present for MIKE; at Bikini for KING)	70

Notes:

^aPlus 10 comprising the escort division.

^bIncluding crews of fixed-wing aircraft and helicopter with personnel, totalling 48.

^cSee 21 August and 2 September.

Table 8. Task Group 132.3 strength during IVY.^a

Task Group Element	Officers	Enlisted Men	Civilians	Total
Headquarters	17	44	1	62
132.30 (Weapons Element)				
<u>USS Curtiss</u> (AV-4)	39	683		722
Marine Detachment	3	64		67
132.31 (Transport Element)				
<u>USS Estes</u> (AGC-12)	48	518		566
<u>USS LST-836</u>	6	123		129
<u>USNS David C. Shanks</u> (T-AP-180)	5	17	169	191
<u>USNS General E.T. Collins</u> (T-AP-147)	5	16	171	192
<u>USS Leo</u> (AKA-60)	12	216		228
132.32 (Service and Harbor Control Element)				
<u>USS Oak Hill</u> (LSD-7)	19	211		230
Boat Pool Detachment	4	198		202
<u>USS Agawam</u> (AOG-6)	8	114		122
YOG-69		14		14
<u>USS Lipan</u> (ATF-85)	5	74		79
<u>USS Yuma</u> (ATF-94)	5	71		76
Underwater Detection Unit	1	20		21
<u>USS Arikara</u> (ATF-98)	5	75		80
MV Horizon		1	36	37
<u>USS Elder</u> (AN-20)	4	45		49
132.33 (Destroyer Element)				
Commander and Staff, Division 11	5	5		10
<u>USS Carpenter</u> (DDE-825)	15	261		276
<u>USS Fletcher</u> (DDE-445)	17	241		258
<u>USS Radford</u> (DDE-446)	18	238		256
<u>USS O'Bannon</u> (DDE-450)	17	234		251
132.34 (Convoy and Escort Element)				
<u>USS Rendova</u> (CVE-114)	72	804		876
Composite Squadron Three (VC-3)	9	33		42
Service Squadron Seven (FASRON-7)	6			6
Helicopter ASW Squadron Two (HS-2)	12	22		34
Marine Component Air Department	8	6		14
Patrol Plane Unit				
Patrol Squadron Two (VP-2) and FASRON-110	47	298		345
Total Task Group 132.3	412	4,646	377	5,435

Note:

^aThe disagreement with Table 7 in number of personnel for some units is because the totals were extracted at different times during the operation. Also, crews of other units were aboard Oak Hill (LSD-7) when it arrived in the Pacific Proving Ground.

Source: Reference C.3.1.

Table 9. Planned buildup of Task Group 132.4 in the forward area, IVY.

Unit	Operational Strength			Equipment	Arrival in Forward Area
	Officers	Enlisted Men	Civilians		
Kwajalein					
Hq Task Group 132.4	43	75	1		30 Sep
Test Support Unit	27	341		4 C-47	3 Oct
Housekeeping	3	279		1 B-25 (ZI only) ^a	
Test Aircraft Unit					
Flight "A"				2 B-50	26 Sep
Control-tanker-bomb	68	154		10 KB-29	3 Oct
Drop instrumentation				2 B-29	3 Oct
Maintenance element	8	164	1		29 Sep
Effects element	19	71		1 B-36 1 B-47 1 B-29	26 Sep 28 Sep 6 Oct
Flight "B"					
Sampler element	34	121	3	16 F-84G	1 Oct
Flight "C"					
Drop element	22	66		2 B-36H	17 Oct
Test Service Unit					
Weather reconnaissance	56	253		10 WB-29	5 Oct
Weather reporting	2	9			30 Sep
Communications	11	143			30 Sep
Search and rescue	8	9		2 SA-16	10 Jun
	8	12		2 SB-29	
	1	2		1 H-19	2 Oct
Photo Element	32	32		3 C-54 1 RB-50	12 Oct 15 Oct
Sample Return (transient element, not included in totals)	9	9		3 R6D	25 Oct
Kwajalein Total	342	1,731	5	58 aircraft	

(continued)

Table 9. Planned buildup of Task Group 132.4 in the forward area, IVY (continued).

Unit	Operational Strength			Equipment	Arrival in Forward Area
	Officers	Enlisted Men	Civilians		
Enewetak					
Test Support Unit	31	187	1	15 L-13 (liaison)	In place
		20		2 H-19 (helicopters)	3 Jun
		15		1 B-17 (CJTF)	24 Sep
				3 H-13 (Army helicopters)	
Test Services Unit					
Weather reporting	10	26			30 Sep
Communications	3	63			15 Sep
Enewetak total	44	311	1	21 Intra-atoll aircraft	
Weather islands					
Test Services Unit					
Weather reporting	4	64			30 Sep
Communications		16			30 Sep
Weather islands total	4	80			
Task Group 132.4 Totals					
Kwajalein	342	1,731	5	58 aircraft	
Enewetak	44	311	1	21 aircraft	
Weather Islands	<u>4</u>	<u>80</u>	<u>—</u>	<u> </u>	
	390	2,122	6	79 aircraft	

Notes:

^aZI - Zone of the Interior (continental United States; not included in Kwajalein totals).

Source: Reference C.O.2, Change No. 3, p. C-5.

Table 10. Actual buildup of Task Group 132.4 in the forward area, IVY.

Date	Rear Echelon	Kwajalein	Enewetak	Weather Islands	Total
1 Feb	78	0	79	0	157
1 Mar	233	0	79	0	312
1 Apr	365	1	79	0	445
1 May	464	1	128	0	593
1 Jun	880	274	191	0	1,345
1 Jul	2,007	274	281	0	2,562
1 Aug	1,854	421	201	6	2,482
1 Sep	1,688	62	281	63	2,094
1 Oct	1,210	946	23	83	2,262
1 Nov	85	2,100	3	84	2,272

Source: Reference C.4.2.

Table 11. Expected distribution of IVY task force personnel, October 1952.

Service Element	Enewetak Atoll			Kwajalein		
	Officers	Enlisted Men	Civilians	Officers	Enlisted Men	Civilians
Hq JTF 132	48	50	3	1	0	0
TG 132.1	80	117	1,745	31	40	47
TG 132.2	77	1,153	0	0	0	0
TG 132.3	340	4,303	442	61	341	0
TG 132.4	0	0	0	386	2,042	6
Total	545	5,623	2,190	479	2,423	53

Service Element	Other			Total		
	Officers	Enlisted Men	Civilians	Officers	Enlisted Men	Civilians
Hq JTF 132	27 ^a	39 ^a	1	76	89	4
TG 132.1	2 ^b	14 ^b	48 ^c	113	171	1,840
TG 132.2	0	0	0	77	1,153	0
TG 132.3	0	0	0	401	4,644	442
TG 132.4	4 ^d	80 ^d	0	390	2,122	6
	5 ^e	13 ^e	0	5	13	0
	1 ^f	7 ^f	0	1	7	0
Total	39	153	49	1,063	8,199	2,292

Notes:

^aRear echelon, Washington, D.C., and task force personnel officers at Oakland and San Francisco, California; Hickam AFB, Hawaii; and Kwajalein.

^bLocated at Bikini, Wake, Guam, Midway, and Hawaii.

^cLocated at Bikini, Johnston, and Wake islands.

^dWeather islands.

^eRear echelon at Kirtland AFB, New Mexico.

^fPort Liaison Detachment to remain in the continental United States.

Source: Reference B.O.2, Change No. 3, p. C-6.

TASK GROUP 132.1 (SCIENTIFIC). The scientific task group was organized as shown in Figure 8. TG 132.1 work in the forward area was performed by 11 task units (TU) (Reference C.1.1, pp. 26-27, 39, 55-60):

- TU 132.1.1 (Scientific Programs) -- Designed and carried out the experiments for weapon design and weapon effects in coordination with the DOD and the contractors of both DOD and AEC.
- TU 132.1.2 (Production) -- Primary mission was production of special materials in the large amounts required for the MIKE shot.
- TU 132.1.3 (Special Materials Facilities) -- Tasked with moving the special materials from Parry to the shot cab on Eluklab and handling them there. Specially designed trucks were used. The task unit was directed by employees of the Cambridge Corporation.
- TU 132.1.4 (MIKE Assembly) -- Prepared the components of the MIKE device for shipment and assembled the device on Eluklab.
- TU 132.1.5, (KING Assembly) -- Assembled the KING weapon in the United States, supervised its transportation by air to Kwajalein, and its loading into the drop aircraft.
- TU 123.1.6 (Firing Party) -- Consisted of a team that armed the MIKE device, and a team that fired the device from a control room on the Estes.
- TU 132.1.7 (Radiological Safety) -- Responsible for technical support to the entire task force. This included training, monitoring, instruments, equipment, and supplies. This unit also procured, issued, and processed the film badges for the entire task force and kept the exposure records. (Radiological safety is treated in detail in Chapter 2.)
- TU 132.1.8 (Technical Photography) -- Photographed the shots and scientific equipment as required to illustrate reports. The unit maintained darkroom facilities for the rest of the task group.
- TU 132.1.9 (Documentary Photography) -- Organized and supported by the Air Force Lookout Mountain Laboratory. The unit obtained the still photographs and motion pictures needed to document the test series.
- TU 132.1.10 (Test Facilities) and TU 132.1.11 (Base Facilities) -- Essentially the H&N organization in the proving ground, overseen by a number of AEC officials for the operational period. TU 132.1.10 was responsible for the test facilities, and TU 132.1.11 ran the four H&N camps.

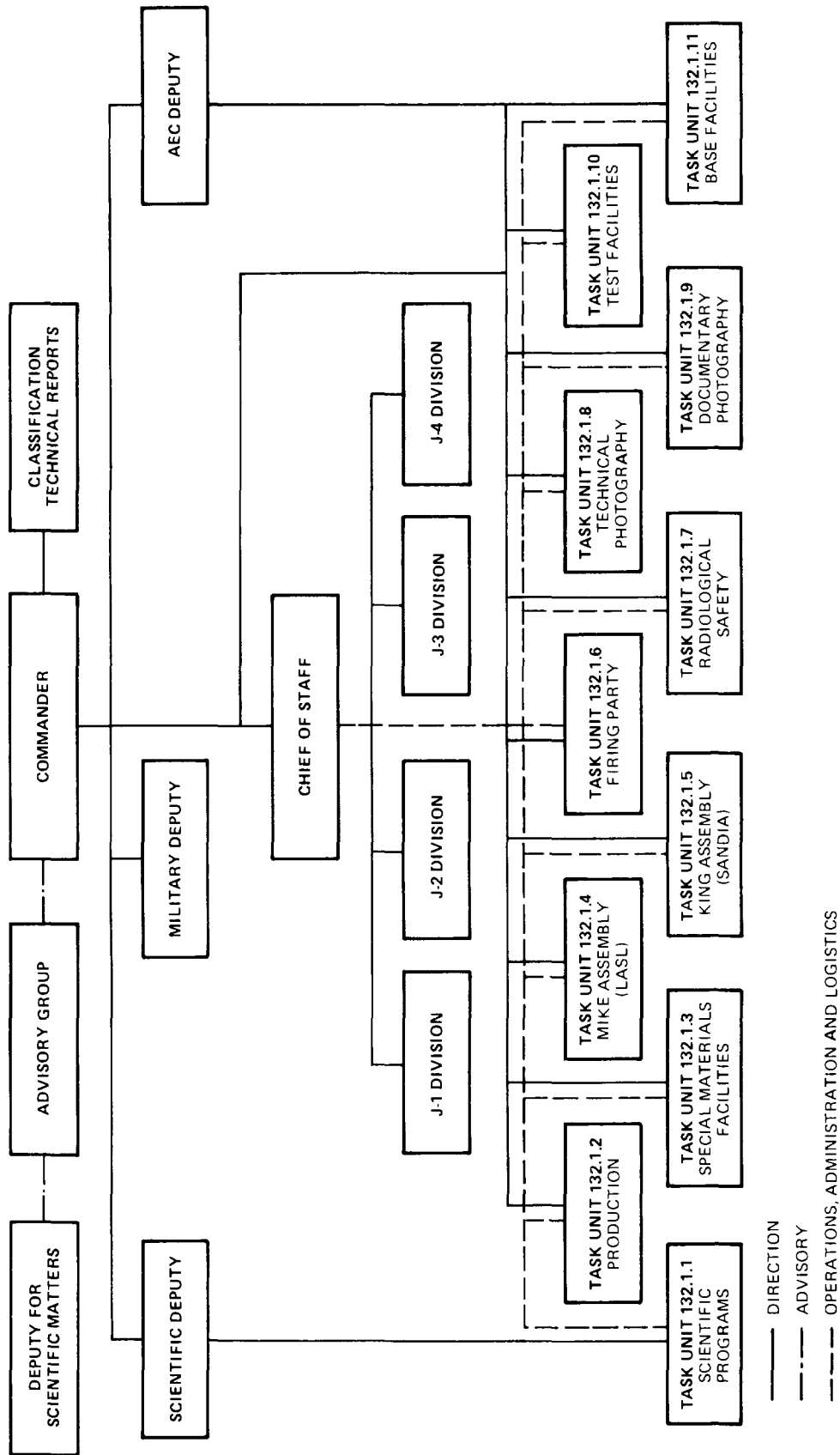

Figure 8. Organization of Task Group 132.1, IVY.

TASK GROUP 132.2 (ARMY). Figure 9 shows the Army task group organization. It was assigned the following broad missions (Reference B.0.2, p. 3):

1. Provide for the ground security of Enewetak Atoll
2. Maintain and operate the signal communications system
3. Maintain and operate Enewetak Atoll port facilities, including stevedoring, in coordination with TG 132.1
4. Maintain all base facilities on Enewetak Island except those specifically allocated to TG 132.1 and TG 132.4.

Military police work probably accounted for much of the time members of TG 132.2 spent off Enewetak Island. Within the limits of radiological safety, surface security sweeps were conducted every 4 days or as directed by CJTF 132. Air sweeps were conducted daily, although it is not clear whose aircraft were used. The military police of the 7126th Army Unit and the 516th Military Police Service Company were combined to man police posts on Enewetak, Parry, Runit, and Dridrilbwiij as follows:

Enewetak	3 officers and 84 enlisted men
Parry	2 officers and 58 enlisted men
Dridrilbwiij	2 officers and 38 enlisted men
Runit	1 officer and 19 enlisted men.

Vessels of the task group boat pool were used for the surface security sweeps. Moreover, the boat pool's DUKWs were used extensively to support the off-island reef activities of TG 132.1 (Reference C.0.1, p. 118; Reference C.2.1, pp. xiii-4).

TASK GROUP 132.3 (NAVY). The naval task group had the following missions (Reference B.0.2, p. 3):

1. Provide for the security of the Enewetak danger area by:
 - a. Maintaining the status of the closed area
 - b. Detecting, warning, and escorting unauthorized vessels and aircraft out of the danger area
2. Meet the requirements of TG 132.1 for suitable water transportation and shipboard assembly facilities for the MIKE device
3. Provide shipboard command facilities for the task force commander and administrative space for the headquarters of TG 132.1 and TG 132.2

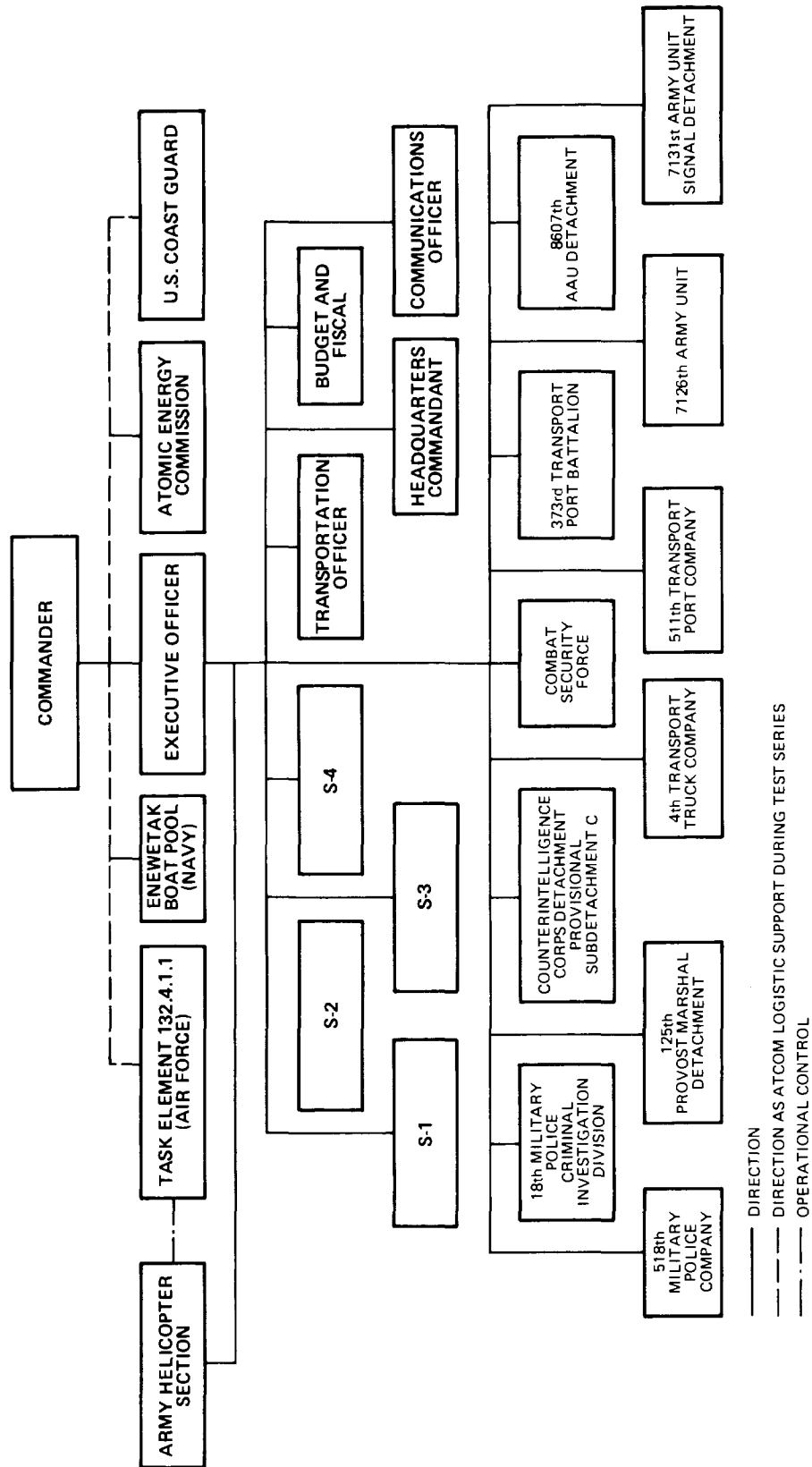

Figure 9. Organization of Task Group 132.2, IVY.

4. Provide ship-to-shore and intra-atoll surface and helicopter transportation, including flights for damage survey and recovery of scientific samples and film
5. Provide shipboard facilities to house the joint task force while afloat.

In the proving ground, CTG 132.3 organized his forces into seven major components (see Figure 10). Their functions are detailed in Table 12. With the exception of the members of the Patrol Plane Unit, which was based on Kwajalein, all task group personnel apparently were housed aboard the task group's ships.

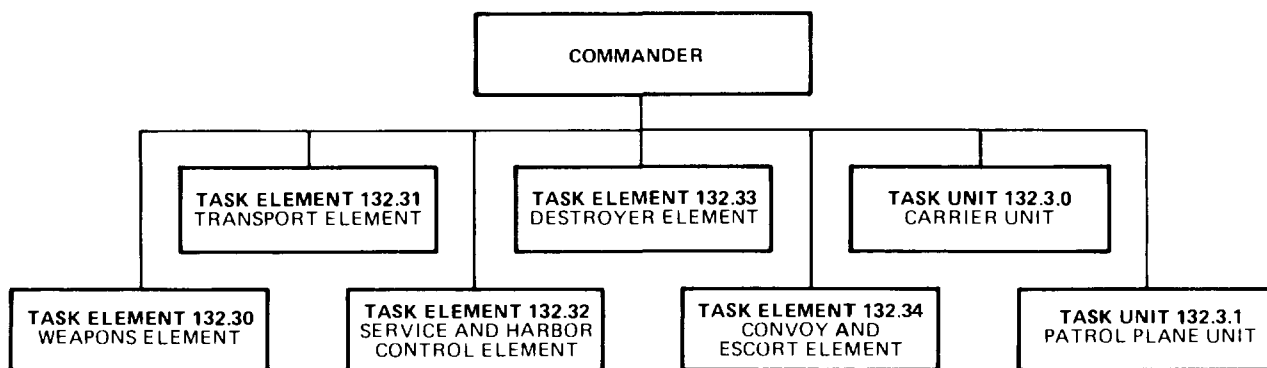

Figure 10. Organization of Task Group 132.3, IVY.

TASK GROUP 132.4 (AIR FORCE). The main body of the Air Force task group was based on Kwajalein Atoll. The task group organization of its elements is shown in Figure 11.

The task group's primary mission was to provide the aircraft and personnel for collecting and recording data as required by the scientific programs. In addition, the task group was to:

1. Augment existing and base facilities at Kwajalein and operate adequate airbase facilities at Enewetak
2. Operate both intra-atoll and interatoll air transportation at Enewetak
3. Provide weather reconnaissance, analysis, and forecasting
4. Augment existing search and rescue (SAR) activity at Kwajalein
5. Provide tactical and administrative communications.

Table 12. Elements and functions of Task Group 132.3, IVY.

Task Element/Unit	Ship Name/ Hull Number	Function
Headquarters Staff TG 132.3		Overall command responsibility for TG 132.3; located aboard <u>USS Rendova</u> (CVE-114)
TE 132.30 (Weapons Element)		
TU 132.30.0	<u>USS Curtiss</u> (AV-4) and Marine detachment	Transported MIKE device to Enewetak; provided laboratory facilities for TG 132.1; evacuated key scientists; involved in Projects 5.4a, 6.2, 6.7a, and 7.5 during MIKE; at Kwajalein for KING
TU 132.30.1	DDE as assigned from TE 132.33	See TU 132.33.1
TU 132.30.2	DDE as assigned from TE 132.33	See TU 132.33.2
TE 132.31 (Transport Element)		
TU 132.31.0	<u>USS Estes</u> (AGC-12)	Command and firing ship on MIKE with CTG 132.1, scientists, and senior air controller embarked; provided air control for KING flight operations; supported Projects 5.4a and 7.5 during MIKE
TU 132.31.1	<u>USS LST-836</u>	On independent duty at Bikini Atoll to assist construction during MIKE and KING
TU 132.31.2	<u>USNS David C. Shanks</u> (T-AP-180)	Evacuated task force personnel for MIKE; not present for KING
TU 132.31.3	<u>USNS General E.T. Collins</u> (T-AP-147)	Evacuated task force personnel for MIKE; provided KING emergency evacuation capability
TU 132.31.4	<u>USS Leo</u> (AKA-60)	Evacuated task force personnel for MIKE; not present at KING
TE 132.32 (Service and Harbor Control Element)		
TU 132.32.0	<u>USS Oak Hill</u> (LSD-7)	Maintained boat pool; evacuated boat pool for MIKE shot; supported Projects 5.4a and 11.5 on MIKE, Project 7.5 on KING, and Project 6.11 on both shots
TU 132.32.1	Boat Pool (3 AVRs, 19 LCMs, 4 LCP(L)s, and 5 LCUs)	Supplied intra-atoll surface transportation
TU 132.32.2 (Fueling Unit)	<u>USS Agawam</u> (AOG-6), YOG-69, YON-146	Provided fueling services to the task group; <u>Agawam</u> supported Project 5.4a on MIKE shot
TU 132.32.3 (Towing Unit)	<u>USS Lipan</u> (ATF-85)	Provided towing and harbor services; supported Projects 5.4a, 6.4b, and 11.4; contaminated while operating in the lagoon after MIKE
TU 132.32.4 (Towing Unit)	<u>USS Yuma</u> (ATF-94)	Provided towing and harbor services; supported Projects 5.4a and 6.7a for MIKE

(continued)

Table 12. Elements and functions of Task Group 132.3, IVY (continued).

Task Element/Unit	Ship Name/ Hull Number	Function
TU 132.32.5 (Underwater Detection Unit)		Operated hydrophone system across lagoon entrances for atoll security
TU 132.32.6 (Towing Unit)	<u>USS Arikara (ATF-98)</u>	Provided towing and harbor services
TU 132.32.7 (Seismographic Unit)	<u>MV Spencer F. Baird</u>	Not in area for MIKE; at Bikini for KING; supported Project 11.4 following KING shot
TU 132.32.9 (Special Mooring Unit)	<u>USS Elder (AN-20)</u>	Supported Project 6.7a on MIKE; departed before KING
TE 132.33 (Destroyer Element) Commander and Staff, Escort Division 11		
TU 132.33.0	<u>USS Carpenter (DDE-825)</u>	Overall command responsibility for TE 132.33; located aboard <u>USS Carpenter (DDE-825)</u>
TU 132.33.1	<u>USS Fletcher (DDE-445)</u>	Patrolled in vicinity of Enewetak Atoll; served as plane guard for <u>Rendova</u> during shots; escorted <u>Curtiss</u> to and from the Pacific Proving Ground (PPG); involved in Project 5.4a
TU 132.33.2	<u>USS Radford (DDE-446)</u>	Patrolled in vicinity of Enewetak Atoll; guarded <u>Curtiss</u> at Enewetak; escorted <u>Curtiss</u> during sorties, trips to and from the PPG; involved in Project 5.4a
TU 132.33.3	<u>USS O'Bannon (DDE-450)</u>	Patrolled in vicinity of Enewetak Atoll; involved in Project 5.4a, served as air control destroyer between Enewetak and Kwajalein atolls for TG 132.4 aircraft during shots; escorted <u>Curtiss</u> to and from the PPG
TE 132.34 (Convoy and Escort Element)		See TE 132.30 and TE 132.33
TU 132.3.0 (Carrier Unit)	<u>USS Rendova (CVE-114)</u> , 6 <u>F4U-5Ns</u> , 4 <u>TBM-3Rs</u> , HS-2	Flagship for CTG 132.3; hosted mobile radiological laboratory and safety unit of TG 132.1; fighter combat air patrol; ship-to-shore helicopter transportation; assisted in Projects 5.4a, 7.5 and 9.2
TU 132.3.1 (Patrol Plane Unit)	9 <u>P2V-4s</u> , 3 <u>P2V-5s</u> , 2 <u>PBM-5As</u> (Kwajalein based)	Air search and antisubmarine patrol; air escort unit for weapons unit; resupply of weather stations; AEC Worldwide Fallout Monitoring Program; supported Projects 5.4a, 6.7a, and 9.2

Sources: Reference C.3.1, pp. 148-149; Reference B.0.2, pp. C-3 and C-4.

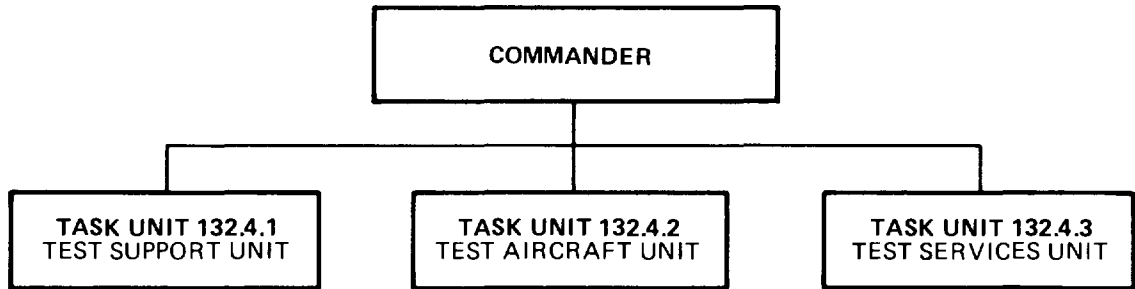

Figure 11. Organization of Task Group 132.4, IVY.

The major elements of the task group had the following missions:

- Test Support Unit (TU 132.4.1)
 - Administer task group headquarters
 - Establish or augment airbase and support services and facilities at Enewetak and Kwajalein for the operation and maintenance of TG 132.4 aircraft
 - Furnish administrative support aircraft for TG 132.4 requirements including documentary photography
 - Provide aircraft and personnel decontamination services and facilities at Kwajalein
 - Furnish both intra-atoll and interatoll airlift at Enewetak
 - Augment existing housekeeping services and facilities in support of TG 132.2 at Enewetak and TG 132.3 at Kwajalein
- Test Aircraft Unit (TU 132.4.2)
 - Provide a minimum of 12 airborne cloud-sampler fighter aircraft in the target area for 1 to 3 hours during each shot at altitudes of 43,000 to 46,000 feet (13.11 to 14.02 km)
 - Airdrop a nuclear device
 - Provide airborne refueling capabilities
 - Provide airborne flight controller aircraft
- Test Services Unit (TU 132.4.3)
 - Provide weather service at Enewetak and Kwajalein and reporting stations at Ponape, Majuro, Bikini, and Kusaie
 - Provide a Weather Central at Enewetak
 - Conduct weather reconnaissance and operate and maintain necessary weather reconnaissance aircraft
 - Provide air rescue service in the Marshall Islands area.

CHAPTER 2 RADIOLOGICAL SAFETY

Operation IVY posed some unique problems to the Joint Task Force 132 (JTF 132) staff and the Atomic Energy Commission (AEC) because of the predicted large size of the detonations. The MIKE shot was expected to produce a yield far surpassing that of any earlier test, and the radioactive fallout might be a more serious problem both to participants and off-island inhabitants. There was concern that a device detonated in the atmosphere might significantly contaminate the lagoon and restrict its use by fleet ships. The shot would be detonated without benefit of near-shot-time, shot-island weather data because of personnel evacuation requirements. Thus, during the 5 hours between evacuation and detonation, unpredicted shifts in forecast favorable winds could increase the potential of exposing the fleet to fallout.

Two other distinct radiation concerns existed:

- Initial radiations emitted by the detonation and thermal effects. This was controlled by completely evacuating personnel to safe distances from the atoll for shot MIKE
- Residual radiation near the detonation site that posed a problem for recovery of scientific instrumentation and other work. Exposure was controlled by radiological safety (radsafe) personnel using counters and dosimeters.

RADIOLOGICAL SAFETY PLANNING

The Chief JTF 132 Technical Operations Branch (J-3) was also the Chief Radsafe Officer. As such, he was responsible for advising Commander JTF 132 (CJTF 132) on the measures necessary to ensure the radiological safety of all test personnel. The major technical radsafe element of the task force was Task Unit 132.1.7 (TU 132.1.7) of the Scientific Task Group (TG 132.1). The Chief Radsafe Officer was the commander of this unit. Radiological safety of all military and civilian personnel was specified as a command responsibility in Annex H, Operation Plan No. 1-52, and in the later Annex P to Operation Plan 2-52 (B.0.2), and radsafe activities were to be performed through normal command channels. The annex with its three appendixes from the second operation

plan is reproduced in Appendix B of this report. TU 132.1.7 had responsibilities that affected the entire task force, while the other three task groups possessed essentially self-contained radsafe units. Each task group commander was responsible for providing the necessary radsafe personnel for his group.

It was necessary to plan a radsafe program that would take into account the increased size of the detonations. This plan had two major aspects:

- A more intensive radsafe effort for those participating in areas close to the detonations
- A much enlarged program for protection of personnel remote from ground zero.

Although the environmental effects of large yields were not absolutely known, radsafe precautions were established to maintain the levels of personnel exposure at or below limits set within the atomic energy industry (Reference B.0.2).

In February 1952, while the task groups were being organized, CJTF 132 published Operation Order 1-52 (Reference B.0.4), which specified the radsafe responsibilities.

- CJTF 132 was to:
 1. Specify the measures necessary to ensure the radiological safety of task force personnel and furnish technical advisory assistance to task group radsafe officers
 2. Inform the Commander in Chief Pacific (CINCPAC) of the potential for radiological exposure of those living within a radius of 600 nmi (1,110 km) or personnel flying within a radius of 1,000 nmi (1,850 km) of the test site.
- Before the onsite operational phase, task group commanders were to:
 1. Organize radsafe units or elements within their task groups
 2. Require radsafe personnel to review radsafe procedures employed on previous operations and become thoroughly acquainted with existing training measures through attendance at appropriate service schools
 3. Require radsafe personnel to become qualified in the calibration and testing of standard radiac equipment

4. Establish lists of names of all personnel required by the nature of their duties to use dosimeters
 5. Determine those personnel (civilian and military) required to undergo physical examinations
 6. Procure complete allowances of radiac equipment and special clothing.
- The task group commanders were also to require physical examinations of civilian personnel who had to handle radioactive material, or who had to be in the forward areas (i.e., any island or lagoon area north of Parry Island) during or after a shot, of military personnel who might have to work in contaminated areas on shot islands after detonation or on contaminated aircraft, and of all radiological monitors.

The task force radsafe officer detailed uniform radsafe regulations and requirements for the services. Each service, in turn, developed its own radsafe plan based on CJTF regulations. The CJTF regulations appeared in Appendix II to Annex P of Operation Plan 2-52 (see Appendix B of this report) and specified that:

1. Individuals or details working in radiation areas or with contaminated equipment would be accompanied by radsafe monitors to inform them of radiological conditions and of reaching maximum permissible exposure (MPE) levels.
2. A list of all individuals who were expected to enter radioactive areas would be submitted to CTG 132.1 2 weeks before the tests.
3. All islands in the atoll were to be considered surface radiological exclusion (radex) areas after each shot until reported clear by CJTF 132.
4. No aircraft in the air at H-hour was to be closer than 20 nmi (37.1 km) slant range from the detonation point, and, after detonations, no aircraft was to operate inside the air radex area or closer than 10 nmi (18.5 km) from the rising column or visible cloud unless specifically directed otherwise. If a tactical situation arose that necessitated entry into the air radex area, tactical exposure allowance standards would apply.
5. All persons in aircraft at shot time, or at subsequent times when engaged in operations in or near the cloud or radex track, would wear film badges.
6. Pilots and copilots of aircraft would use modified all-purpose 4.5-density filter goggles at shot time; as an extra precaution, copilots were to cover their eyes at H-hour.

7. All airborne task force multiengine aircraft at H-hour within 100 nmi (185 km) of the detonation point would carry a radsafe monitor equipped with suitable radiac equipment as well as a radex area plot. The monitor was to be capable of calculating allowable exposures under both operational and tactical conditions.
8. Transportation of radioactive materials to and from the forward area would conform to AEC regulations for escorted shipment of such material. Monitoring of radioactive test materials en route would be the responsibility of escorting scientific personnel as directed by CTG 132.1.
9. No radioactive material would be removed from the test site except as authorized in the experimental programs.
10. No manned ships were to be permitted inside the lagoon or closer than 25 nmi (46.3 km) from shot islands at the time of detonation. (An exception to this occurred during the KING shot, when USS Estes remained in the lagoon.) Bearings threatening ships with immediate radioactive fallout would be established by CJTF 132 on the basis of forecast wind directions at the time of detonation, and this fallout sector would be designated as a surface radex area. All task force ships would remain outside the sector bearings and radial limitations, and be subject to time restrictions. However, if tactical conditions dictated directing ships into the radex area, their movement would be governed by tactical exposure guidelines.
11. Crews and passengers of task force ships would be protected from blast, heat, and radiation by moving the ships.
12. Boats operating in waters near shot islands after shot time were to be considered subject to contamination, and radsafe monitors would be required for all such craft operating north of Parry Island after shot time until such time as radiological restrictions were lifted.
13. Film badges were to be forwarded regularly to the photodosimetry laboratory of CTG 132.1 for processing and recording. Copies of exposure records were to be furnished to task group commanders.

Task Group 132.1 (Scientific)

TU 132.1.7, the radsafe unit, handled the radiological protection of TG 132.1 personnel and was assigned the following:

1. Technical assistance to task force and task group commanders on matters pertaining to radiological safety, and ensuring that all units complied with CJTF 132 radsafe regulations

2. All ground monitoring services associated with scientific missions, including monitoring of water supplies at inhabited, distant atolls; CTG 132.3 assisted CTG 132.1 in this
3. Establishment of tables of allowable residual radiation levels for equipment, personnel, vehicles, buildings, etc.
4. Laboratory services and technical assistance to all task groups, which included:
 - a. Procuring, storing, and issuing of all film badges and specified supplementary items of personnel radsafe equipment
 - b. Developing and interpreting film badges
 - c. Maintaining film badge exposure records and transmitting duplicate records to task groups
 - d. Providing facilities at the Parry Island Radsafe Building for the calibration, repair and maintenance of instruments, and storage of spare parts for radiac equipment
 - e. Monitoring the removal and packaging of radioactive sources and samples
5. Provision of postshot radsafe surface situation maps to CJTF 132 and task groups requiring such information
6. Procurement of radsafe clothing as necessary for TG 132.1 and other recovery personnel
7. Procurement and issuance of special high-density goggles to specified personnel of JTF 132
8. Assignment of technical personnel to all task groups to inspect radiologically contaminated items and to certify destruction, disposal, or unserviceability of such items as required
9. Provision of personnel decontamination facilities
10. Performance of necessary fallout studies for radsafe documentation
11. Establishment of a radsafe center on USS Rendova.

The personnel procurement problem facing CTG 132.1 was much greater than that of the other task groups since no single organization was capable of supplying a trained cadre of radsafe personnel. Personnel support, to be assigned on a temporary duty basis, was requested of each of the services. Table 13 lists the types and numbers of requested support (Reference C.1.7.1).

Table 13. Radiological safety personnel support requested by Commander, Task Group 132.1, IVY.

Function	Supplying Service			
	Army	Navy	Air Force	Marine Corps
Laboratory director	1			
Monitor -- officer	7	5	7	1
enlisted			2	4
Laboratory technician	4			
Electronics officer		1		
Instrument repairman		3		
Photodosimetry assistant			4	
Clerk	3	1	2	

All requested personnel, with the exception of the instrument repairmen, were actually provided by the services (Reference C.1.1). Most of the requested officer personnel were radsafe engineers and graduates of the 3-year military radsafe course. IVY was expected to provide field experience to these highly trained people. In addition, five civilians, qualified as radiation experts by background and training, operated with TU 132.1.7, three of whom were obtained from the staff of Los Alamos Scientific Laboratory (LASL), one from Evans Signal Laboratory, and one from Oak Ridge National Laboratory.

As the operational phase of IVY got underway, it became apparent that provisions for backup radsafe monitors were necessary, in case unexpected or unusually adverse radiological exposure conditions hindered the normal operations of monitor personnel. To cover such an eventuality, CJTF 132 dispatched a letter to each of the task group commanders on 29 September directing that volunteer commissioned or scientific personnel be selected and trained as backup monitors. The training was to consist primarily of familiarization with simple field-type radiac instruments and their operation and utility, background information, information on nuclear radiations, and field problems. The anticipated employment of these monitors was to be limited commensurately with their training. Nonetheless, they were expected to contribute to the accomplishment

of the mission within their allowed exposures. For planning purposes, the following number of backup monitors was suggested:

JTF 132 Headquarters	10 monitors
TG 132.1	20 monitors
TG 132.2	Participation of previously trained "Q"-cleared personnel
TG 132.3	5 monitors.

Toward the end of the post-MIKE period and just before the KING detonation, the services of the backup monitors were utilized. Some of these were men who acted specifically as monitors for missions, while others were volunteer scientific personnel on the project staff who acted as their own monitors for particular missions. This was quite helpful because many of the TU 132.1.7 monitor personnel had accumulated exposures of more than 2 R during the early post-MIKE period; thus, their services were made available on a standby basis rather than on an active basis. This also ensured an adequate supply of monitor personnel for the post-KING period (Reference C.1.3.614, p. 22).

By seeing a more complete picture of the operation, monitor personnel of TU 132.1.7 were able to plan their activities during the pre-MIKE period more effectively. This knowledge was carried over into the post-MIKE and pre-KING activities (Reference C.1.3.614, p. 22).

The organization of TU 132.1.7 is shown in Figure 12. Major functions of the unit were radiation control, laboratory and analysis, decontamination, and special monitoring.

RADIATION CONTROL GROUP. The Radiation Control Group was responsible for the radiological safety of all personnel entering contaminated areas. The group consisted of survey and escort monitors at Enewetak and monitors at Kwajalein. Survey monitors periodically checked all the islands of Enewetak Atoll for radiation levels, the escort monitors accompanied working parties, and the Kwajalein monitors had several functions that are described subsequently. Additionally, a monitor was stationed on the Scripps vessel MV Horizon, and on USS LST-827, which evacuated Ujelang for the MIKE shot.

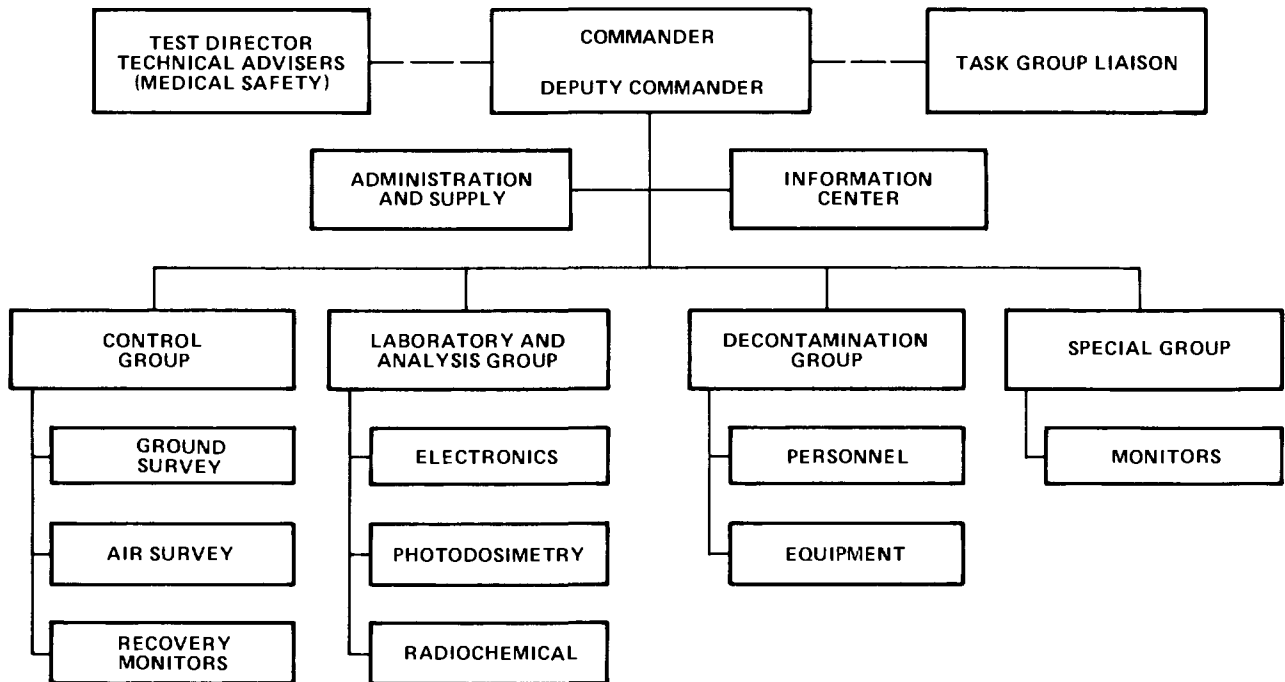

Figure 12. Radiological safety organization of Task Unit 132.1.7, IVY.

The control group officer met daily with the Scientific Deputy of TG 132.1 to plan operations for the following day. The control group station was established in the Radsafe Building on Parry and was transferred to the forward ready room of Rendova before each shot. Current radiological situation maps were maintained at the station for the information of project leaders and escort monitors. Monitors assigned to the various scientific parties were familiarized with the problems that could arise in each operation.

The station maintained a daily operations schedule for the Radsafe Information Center that detailed all missions into contaminated areas, including name of monitor, destination, general type of mission, transportation, and times of departure and arrival. The station was also the clearance point for all working parties before entry into contaminated areas.

Each morning all islands were surveyed by aerial reconnaissance teams and, when necessary, radiation-level signs were posted in specified areas to allow work teams to plan their activities without exceeding the allowable exposure. Areas with levels of radioactivity higher than 0.1 R/hr were delineated and

marked by warning signs. Frequent resurveys were made to reestablish the 0.1-R/hr line. Entries beyond the 0.1-R/hr line required escort by a monitor.

The Kwajalein radiation control group, located at the airstrip, assisted the AEC New York Operations Office (NYKOPO) in the preliminary phases of establishing a radiation survey system throughout the Marshall Islands. This group procured drinking water samples from Ponape, Kusaie, Majuro, and Kwajalein before and after both shots and forwarded them to the Radiological Field Laboratory for analysis.

Representatives of the control group at Kwajalein also supervised the monitoring of samples removed from aircraft of Project 1.3, snap-bag samples of Project 5.4b, and samples for Project 7.3. In addition, they conducted a special program of exposure measurements for pilots of the cloud-sampling aircraft.

Control group personnel served aboard Horizon as technical advisors. Overall radsafe supervision was a command responsibility of CTG 132.3. Horizon was to take station approximately 72 nmi (133.4 km) north of MIKE ground zero at H-hour. This position was of concern since wind predictions indicated that fallout would occur at this location. Consequently, three survey meters, one portable air sampler, eight sets of protective clothing, eight self-reading dosimeters, and enough film badges to supply the crew were placed aboard the ship (Reference C.1.3.624).

LABORATORY AND ANALYSIS GROUP. The Laboratory and Analysis Group furnished support services to the task group; it consisted of three sections -- Electronics, Photodosimetry, and Radiochemistry.

The Electronics Section procured, repaired, calibrated, and maintained the radsafe monitoring instruments for TU 132.1.7 and gave technical assistance to the instrument repair sections of the other task groups.

The Photodosimetry Section issued, processed, and interpreted the film badges and maintained exposure records. These records were on 5x8 cards (Reference C.1.7.3). Data from these records are listed on the Consolidated List of Exposures (Reference C.1.7.2) and are the basis for the exposure tabulations

in this report. Additionally, the section issued, read, and recorded the results of all TG 132.1 personnel dosimeters.

The Radiochemical Section operated a mobile radiological field laboratory (AN/MDR-1[XE-31]), designed and furnished by Evans Signal Laboratory. This laboratory analyzed the radioactivity of air, water, and contaminated objects. Samples were assayed for alpha, beta, and gamma radiation intensity and beta and gamma energy and decay rates. Because the island bases were evacuated for the MIKE shot, the field laboratory was located on the hangar deck of Rendova. The section regularly assayed the seawater at the swimming beach off Parry and the drinking water aboard ship, at Enewetak, and at other nearby inhabited atolls.

DECONTAMINATION GROUP. The Decontamination Group provided the necessary equipment, facilities, and support to avoid the spread of contamination outside the controlled areas. The group carried out this responsibility by providing personnel decontamination stations, equipment decontamination areas, and entry and exit checkpoints.

SPECIAL MONITORING GROUP. One TU 132.1.7 monitor was available for laboratory monitoring in connection with radiological problems that might arise during installation of the MIKE device.

Two additional functions of TU 132.1.7 were Administration and Supply, and an Information Center. The Administration and Supply Group supervised the laundering and issuance of protective clothing. The Information Center operated both afloat and ashore and correlated, as required, all information obtained into an overall picture of the radiological conditions of the operation. Daily situation maps were maintained that showed various radiation levels at all available sites. Records of lagoon sample assays were kept and used as required.

Task Group 132.2 (Army)

Normal staff procedure was used by TG 132.2 to implement all operational plans, orders, and directives issued by CJTF 132. CTG 132.2 was responsible for providing:

1. Basic radsafe indoctrination of all garrison force military personnel and the organization of appropriate radsafe units
2. Training of its own radsafe monitors
3. A laundry for low-level contaminated clothing
4. A contaminated equipment storage area with the necessary security
5. Military decontamination equipment and assistance to CTG 132.1
6. Evacuation of TG 132.2 personnel and equipment based on Enewetak Island
7. Compliance with Interstate Commerce Commission rules (Docket 3666) governing transportation of radioactive materials (this directive prescribed an MPE of 0.3 R per week on a lifetime basis).

A radsafe engineer from TU 132.1.7 was assigned to TG 132.2 as the TG 132.2 radsafe officer. He supervised training and operations of Army units (Reference C.1.7.5). CTG 132.2 specified that all task group personnel were to receive basic radsafe indoctrination. Specialized training in monitoring and decontamination was given to a relatively large number of the garrison force, implying that each company contained a cadre of trained radsafe personnel by the time the operation phase began. Specific extra assignments pertaining to radiological safety were known; for example, the 511th Transportation Port Company operated the personnel decontamination center.

History of Operation IVY (Reference C.0.1) indicates that in September 1951, CJTF 132 sent a letter to CTG 132.2 requesting information on the status of radsafe facilities at Enewetak Island. He was informed that no radiac equipment was available for use by TG 132.2, that no personnel trained in the use of radiac equipment were available in the task group, and that the AEC Resident Engineer had no technical facilities with which to advise CTG 132.2 or to establish radsafe criteria for granting access to the previously contaminated islands of Runit, Eleleron, Enjebi, and Mijikadrek. By late September, the Army was requested to furnish a limited amount of standard radiac equipment to provide CTG 132.2 with the means for fulfilling radsafe requirements during the buildup period. By December, CTG 132.2 was informed that radiac equipment was being procured and would be shipped as it became available. The first shipment, consisting of 12 portable survey meters and 20

low-range dosimeters, was made in late December. Monitors were trained in early 1952. No record of any radiological survey at that time has been found.

Task Group 132.3 (Navy)

Annex P to CJTF 132 Operation Plan 2-52 (Reference B.0.2) (see Appendix B of this report) directed CTG 132.3 to:

1. Ensure that appropriate radiac equipment and qualified personnel were aboard each task group unit, and that each unit was prepared to carry out the radsafe mission of the task group
2. Provide and train radsafe monitors, including one airborne monitor for each multiengine aircraft crew assigned to TG 132.3
3. Provide monitors and decontamination crews aboard each ship within the task group
4. Provide radiac equipment and protective clothing for TG 132.3
5. Provide repair, spare parts, and calibration facilities for TG 132.3
6. Provide a limited laboratory facility for radiochemistry techniques, fallout studies, and film badge development for use by TG 132.1 radsafe operations while the task force was embarked
7. Provide decontamination facilities for TG 132.3 aircraft not based on Kwajalein
8. Provide helicopter air service for postshot surveys by TG 132.1 monitors before task force reentry
9. Provide amphibious aircraft for fallout monitoring and water sample collection from adjacent inhabited islands and atolls.

Other than the protection of personnel, the Navy had two additional radsafe mission objectives: (1) training ship crews to operate in possibly contaminated environments, and (2) evaluating radsafe equipment, procedures, and training so as to be able to modify standard procedures if necessary (Reference B.0.4, Annex J).

Radiological safety was an express command responsibility for each ship. Normal ship staffing for radiological warfare was considered adequate for radsafe purposes. The radsafe function was a responsibility of the shipboard damage control parties.

Early task group planning was concerned mainly with securing the allowance of radsafe instruments and spares, and with ship modifications for washdown systems and personnel decontamination stations (Reference C.3.1, Section III). On 23 May 1952, CINCPAC stated that he considered the radiological safety requirements employed in TG 132.3 to be routine and that his commanders should obtain their radiac instruments through normal channels and train personnel in radiological safety through established training commands (Reference C.3.1, p. 33,).

Task Group 132.4 (Air Force)

CJTF Operation Plan 2-52 (Reference B.0.2) directed CTG 132.4 to:

1. Provide and train radsafe monitors, including one airborne monitor for each multiengine aircraft crew assigned to TG 132.4
2. Provide radiac equipment and protective clothing for TG 132.4
3. Provide repair, spare parts, and calibration facilities for radiac equipment for TG 132.4
4. Provide decontamination crews and facilities for aircraft at Kwajalein Island (only standby decontamination capabilities were required at Enewetak)
5. Assist in decontaminating TG 132.3 aircraft using TG 132.4 personnel at Kwajalein, if required
6. Provide cloud-tracking aircraft for postshot radsafe "situation data" up to a radius of 1,000 nmi (1,850 km) in the significant quadrant for a period of 48 hours after detonation
7. Prepare air radex zones to keep aircraft from unknowingly becoming contaminated.

In response to CJTF Operation Plan 2-52 (Reference B.0.2), TG 132.4 published its own Operation Plan 1-52 on 16 June 1952. The following radsafe tasks were assigned to the TG 132.4 subordinate units (Reference B.4.1, Para. 3):

- Test Support Unit
 1. Provision of aircraft and personnel decontamination services and facilities at Kwajalein, including preparation of sampler aircraft and sample removals
 2. Provision of intra-atoll airlift at Enewetak

3. Establishment of base operations for TG 132.3 and TG 132.4 aircraft and transients, and terminal facilities at Enewetak
 4. Execution of the Evacuation Plan and Reentry Plan at Enewetak
 5. Monitoring the return of samples via Military Air Transport Service (MATS) aircraft
 6. Maintenance of assigned aircraft
- Test Aircraft Unit
 1. Operation of aircraft necessary for the conduct of experimental programs
 2. Maintenance of assigned aircraft
 - Test Services Unit
 1. Provision of weather service
 2. Performance of sampling missions in connection with Air Force scientific programs
 3. Technical and documentary photography
 4. Performance of cloud tracking missions
 5. Maintenance of assigned aircraft.

All TG 132.4 units were directed to conduct training programs "as necessary to insure individual and unit proficiency in radiological safety and in the execution of the various operational and emergency plans" (Reference B.4.1).

INDOCTRINATION AND TRAINING

A primary responsibility of the scientific radsafe unit was training personnel in the concepts and principles of radiation safety. TU 132.1.7, as the principal technical radsafe organization, conducted a series of seminars relating to the technical operations involved in IVY. Recognized authorities within the task force were invited to address these seminars. The guest discussion leaders presented short lectures and then guided discussion periods.

The first indoctrination course was conducted in the forward area from 17 to 22 October 1952. The material discussed during these seminars included:

- Concept of Operation IVY
- Radsafe operations and responsibilities
- Radiological instrumentation
- Photodosimetry, dosimetry, and records

- Weather effects on fallout
- Scientific programs
- Weapon effects
- MIKE and KING descriptive material.

Since TG 132.1 was responsible for radSAFE assistance and technical support of the task force during Operation IVY, and because of the possibility that regularly assigned monitors might receive their prescribed exposure limits before the completion of the operation, availability of the services of a pool of reserve monitors was necessary. Personnel for this pool were made available from the various task groups of JTF 132. Those reserve monitors who did not possess credit for the Armed Forces 6-week training course on radiological safety attended a series of training seminars and practical exercises conducted from 7 to 11 October 1952. The course included:

- Introduction to atomic weapons
- Instrumentation
- Calibration procedures
- Protective clothing and practical decontamination
- Monitoring responsibilities and special instructions applicable to Operation IVY.

The radSAFE training requirements for TG 132.2 were carried out on two levels: basic indoctrination, and instructor and monitor training. The first-level requirement was that all military personnel receive a basic radSAFE indoctrination to ensure intelligent cooperation with decontamination crews. A 6-hour orientation course in radiological safety was presented to most of the TG 132.2 military personnel present in April and May 1952. The course was designed to emphasize the practical aspects of radiological safety and was presented by an officer instructor from the U.S. Army Pacific (USARPAC). The April and May attendance record for this course is listed in Table 14.

Additionally, all newly arrived personnel were shown the SANDSTONE-GREENHOUSE indoctrination film as part of the briefing procedure. In August 1952, a 4-hour basic radiological indoctrination course was conducted by the task group radSAFE officer, which was repeated for all new arrivals. One-hundred-percent troop participation was attained.

Table 14. Radiological safety course attendees, IVY.

Date of Class	Enlisted	Officers
28 April 1952	36	1
29 April 1952	38	4
30 April 1952	51	3
1 May 1952	39	2
2 May 1952	28	3
5 May 1952	45	3
6 May 1952	31	2
7 May 1952	51	7
8 May 1952	63	3
9 May 1952	36	4
Totals	418	32

The second level of instruction was for radsafe specialists trained as unit radsafe officers, monitors, and decontamination technicians. This specialized training was completed in two stages. First, selected officers and enlisted men were sent either to the Fleet Training Center at Pearl Harbor to take practical Atomic Defense Course No. 425, or to the USARPAC Chemical, Biological, and Radiological Defense School at Schofield Barracks in Hawaii to take the advanced course for noncommissioned officers in chemical, biological, and radiological warfare. This practice began in early 1952, and training of unit personnel was well underway by the time the task group radsafe officer arrived. During July, 20 men attended these courses, and 18 men attended during August.

The second stage of specialized training consisted of training these appointed personnel for the specific problems that might be encountered by the task group radsafe officer. Practical training was given in the use, care, and maintenance of radiac instruments, and intensified instruction was provided for monitors in such duties as making ground surveys, monitoring for groups, and personnel monitoring. Six field problems were conducted at Enjebi to provide more realistic training scenarios. A task group decontamination

team was organized and given special training in mobile equipment and aircraft decontamination procedures. Personnel for this team were selected mainly from the Post Fire Department and Motor Maintenance Section.

On 17 September 1952, Operation Plan 2-52 (Reference B.0.2) was implemented and operational control of those Air Force units stationed on Enewetak passed from CTG 132.2 to CTG 132.4. Nevertheless, all task group elements on Enewetak Island were trained in a coordinated effort, and all radiac equipment was divided on a pro rata basis.

Throughout September and October 1952, the training of all TG 132.2 elements centered on preparation for the evacuation and reentry missions for the MIKE event. It was believed that Enewetak Island could become contaminated by fallout if the weather conditions following MIKE were unfavorable. Because of this possibility, preshot monitoring and decontamination training were intensified so that each unit would be capable of detecting the extent and intensity of contamination and establishing effective decontamination techniques. The training subjects and methods of instruction were designed to improve individual radsafe proficiency, and emphasized the practical application of these skills.

Three reentry monitoring teams, each consisting of one control officer and six monitors, were organized and trained in the specific measures to be taken if TG 132.2 returned to a contaminated island after the MIKE shot. This planning included the preparation of maps of Enewetak Island and the assignment of segments of responsibility to each team of monitors. Points at which readings were to be taken were designated, and practice surveys of the island were conducted. It was determined that a detailed survey of Enewetak Island could be made in approximately 30 minutes.

A personnel decontamination center was set up in Building 125. This center was to be operated by the 511th Transportation Port Company, which received specific instruction regarding its duties. Two mobile laundry units were designated for radsafe use, and laundry personnel were trained in the precautions to be taken while washing contaminated clothing.

The commanding officers of surface and air units of TG 132.3 were directed to take every opportunity to train key officer and enlisted personnel of the unit radsafe organizations, using the facilities available at regular training centers such as the Damage Control School, Treasure Island, San Francisco, and at fleet training centers at San Diego and Pearl Harbor. On-the-job training, consisting principally of lectures and drills, was emphasized. The objective of this training was to develop the operational efficiency necessary to carry out the radiological defense mission of the fleet. Satisfactory radiological defense was assumed to require satisfactory radsafe procedures.

The earliest TG 132.4 training was for sampler pilots and their ground crews. On 2 March 1952, LASL decided to use the radioactive clouds of Operation TUMBLER-SNAPPER at the Nevada Proving Ground (NPG) for training. Aircraft and crews were to participate in the final six shots, according to a request made by LASL to the Air Force Special Weapons Center (AFSWC); AFSWC approved on 26 March. From 7 to 11 April, classroom training for 30 F-84G pilots was conducted at Kirtland AFB by the 4925th Test Group Rad Section. Eleven officers and three airmen from the 4925th also completed this classroom training (Reference C.4.4, May-June Inst, p. 50).

The 30 F84-G pilots who had received classroom training at Kirtland AFB and 60 maintenance men participated in Operation TUMBLER-SNAPPER shots using five F-84Gs based at Indian Springs AFB, Nevada. Details concerning sampler penetrations of atomic clouds during TUMBLER-SNAPPER are contained in the report of atmospheric testing conducted at the NPG, Operation TUMBLER-SNAPPER (DNA 6019F).

On 16 June 1952, TG 132.4 published Training Directive No. 2, which established minimum requirements for individual training. Provisions of that directive pertaining to individual radiological training include (quoted from Reference C.4.6, Enc., pp. 1-2):

- The minimum requirements set forth herein are to be used as a guide only. Unit commanders should place emphasis on the quality of training rather than a minimum hourly requirement. Subjects to be covered and suggested hourly minimum to be devoted to each are noted below:

- Radiological Training:
 - Orientation Minimum - 5 Hours
 - Decontamination Minimum - 5 Hours
 - Monthly Refresher - 1 Hour
 - Decontamination Refresher - Frequent Drills

- Each unit will appoint a Radiological Training Officer whose responsibility it will be to carry out the training programs as directed. The Radiological Safety Officer, TG 132.4. will function in a supervisory capacity.
- Orientation of all personnel in radiological safety factors and decontamination training will be a continuous activity after the initial indoctrination.

The Test Support Unit (TSU) conducted a radsafe orientation for TG 132.4 personnel at Kirtland AFB during the week of 14 July. Training of personnel at Kwajalein was started on 6 August. Eight men of the 11th Air Rescue Service and the 6th Weather Squadron attended a 5-day radiological training course at the Navy Fleet Underway School, Pearl Harbor. Distribution of informational radsafe manuals was started on 19 August. This manual was prepared by the TG 132.4 Radsafe Officer and was packaged for shipment to Kwajalein and distribution to TG 132.4 personnel (Reference C.4.4, pp. 44-45).

Operation Texan, a full-scale rehearsal for IVY involving the same distance (369 nmi [683 km]) between the planned KING shot and Kwajalein, was conducted out of Bergstrom AFB, Texas, on 13 August 1952. The rehearsal allowed crews of effects aircraft, drop aircraft, samplers, sampler controllers, and tankers to practice mission and communications procedures.

By the end of August 1952, the required 5-hour training course on radiological safety had been completed by 99 percent of all assigned TSU personnel at Kwajalein. Plans were also formulated to hold special make-up classes for anyone who missed the course (Reference B.4.7, p. 69). All personnel (100 percent) of the Test Aircraft Unit (TAU) were trained. Training ceased by 25 August 1952 in preparation for movement to the forward area (Reference B.4.7, p. 75).

On 18 October 1952, TG 132.4 executed Operation Order 2-52 (Reference B.4.2), a rehearsal for MIKE staged out of Kwajalein to the exact point planned

for MIKE at Enewetak Atoll. TG 132.3 furnished Rendova for radar backup and Estes to exercise the Air Operations Center (AOC) in its Combat Information Center. At Kwajalein, decontamination operations were rehearsed by all TG 132.4 units with special emphasis on protecting personnel against radiological conditions. The AOC at Kwajalein also practiced the preparation of an air radex area using forecast winds at 40,000 feet (12.19 km) for H-6 on 18 October (Reference C.4.4, 1 Sept-31 Oct Inst, p. 60).

The Test Support Unit (TSU) conducted a training course for Navy radsafe monitors on 22 to 25 September at Kwajalein. It also conducted a radsafe orientation for Navy personnel on 13 to 15 October. During October, the training of fallout-monitoring weather personnel on the weather islands was completed (Reference C.4.10, Oct Inst).

PERSONNEL PROTECTION

Pretest Physical Examinations

All IVY radsafe operations were treated as routine and complied with the established permissible radiological exposures for routine work, except for those activities designated specifically as special operations by CJTF 132 (Reference C.0.1).

In order to better control and record these routine exposures, criteria governing radiological physical examinations for task force personnel were promulgated by the task force headquarters early in 1952. It was stipulated that:

1. Physical examinations would be required for all civilian task force personnel who handled radioactive material, or who would be in the forward area (north of Parry) during or after shot time. In addition, physical examinations would be required for military radsafe monitors, and all military personnel who were to work in areas containing radioactivity or be on shot islands after detonation, work on contaminated aircraft, or work with radioactive products. Enewetak Island and other administrative and housing islands, however, were not to be considered as contaminated areas.
2. Examinations were to be given within 3 months of movement to the forward area, except in the case of civilian personnel employed at LASL, for whom special arrangements had previously been made. One copy of the physical

examination results -- including analysis of chest X-ray, complete blood count, and urinalysis -- was to be forwarded to CJTF 132, and one copy retained by the task group concerned.

3. Personnel required to have such examinations would not be allowed to leave the continental United States before compliance.

Radiation Safety Standards

Radiation criteria were based on AEC industrial safeguards. Two types of radsafe protection standards were used in Operation IVY: a maximum permissible exposure (MPE), which related to an individual's accumulated whole-body exposure over the entire operation, and a maximum permissible limit (MPL), which referred to the amount of radioactive contamination allowed to remain on personnel or equipment.

Radsafe criteria based on AEC industrial safeguards were approved by the Surgeons General of the Army and Air Force, the chief of the Navy Bureau of Medicine and Surgery, and the Director, AEC Division of Biology and Medicine. CJTF 132 disseminated operational rules for radiological situations as Annex P to JTF 132 Operation Plan 2-52 (Reference B.0.2). Each task group implemented the annex with its own orders or plans.

The radsafe criteria measuring units were the roentgen (R) and the rem. The roentgen, a measure of radiation in air, denotes an exposure intensity. The rem is a unit of radiation dose, i.e., a measure of radiation energy deposited within the body that takes into account its capability of causing an effect in human tissue. Both units are measurable in fractions, such as a milliroentgen (mR) or a millirem (mrem). These units are 1/1,000th of the roentgen or the rem. For most forms of ionizing radiation, such as beta and gamma, the rem dose is less than the roentgen exposure, for not all of the energy measurable in air penetrates body tissues. Another unit often used in discussing radiation doses is the rad. The rad is a measure of radiation energy deposited in any material; for biological tissue, a rad of the "quality" of radiation as gamma- or X-rays essentially equals a rem.

At the time of the IVY series the distinction was usually not made between exposure (properly expressed in units of roentgens) and absorbed dose (properly

expressed in units of rem, although at the time often expressed in roentgens); presumably external whole-body exposure and absorbed dose were assumed equivalent. This report expresses the measured data in exposure units (roentgens). Although the original references often referred to dose, there is no evidence that whole-body energy deposition was determined, nor that the dose was indeed measured.

In this report all measurements of exposure intensity (roentgen) are given in whole units and decimal fractions. This is not the way these are commonly reported in the source literature. The lower exposure intensities were usually reported in milliroentgens and the higher exposure intensities in roentgens. Some measuring devices could measure both the lower and higher intensities, but with different dial settings and thus differing accuracies.

Personnel records show the same sorts of differentiation. The lower individual exposures are usually recorded in milliroentgens, but the larger maximums allowed or permitted are stated in whole roentgens or whole rems. This use of different measuring units for different levels of radiation could cause some confusion to readers who are unfamiliar with the field; therefore, the whole-unit convention is used.

The only standard directly promulgated by CJTF 132 to all task groups was an MPE of 3.0 R for the entire operation (Reference B.0.2, Annex P). All of the radSAFE planning documents refer to the 3.0-R MPE; however, History of Operation IVY (Reference C.0.1) and Radiological Safety (Reference C.1.7.1) show that the MPE was 3.9 R. This MPE was based on an AEC Division of Biology and Medicine authorization (Reference C.1.7.5).

The change from 3.0 R to 3.9 R was also based on a quarterly dose (or 13-week) allowance. This was done to permit the operation to extend from 10 to 13 weeks. (In industry the maximum permissible dose per year was 15 R, assuming 2 weeks vacation per year, hence 3.9 R per quarter.) The only documentation for the change from 3.0 to 3.9 R was found in the TG 132.4 history (Reference C.4.6, p. 30), which states that the exposure was "later raised to 3.9 R." The TG 132.4 history cites a JTF TWX, "JTF 132 DTG 100615Z (TGAG#TX-1159)," as the authority for the change. The month and year of the TWX are undetermined.

At the time, the two limits were probably believed to represent about the same degree of safety. The military regulations on radiological safety in effect then were somewhat ambiguous. The military MPE for whole-body exposure was 0.3 R integrated over a period of a week,* but the level recommended for routine operations was 0.05 R (or less) per 24-hour period. If routine exposures exceeded 0.3 R per week, the individual was to be removed from further exposure until his total averaged less than the 0.3 R per week. The 0.3-R-per-week criterion was the same as the AEC criterion for atomic workers. That criterion would result in an exposure of 15.6 R per year, or 3.9 R per quarter year.

A slightly different limit was established for individuals who worked with external radiation for a period of less than 2 years. These individuals were allowed 1.25 R per month. The yearly total exposure for the 2-year limit was slightly smaller (15 R versus 15.6 R for the 0.3-R-per-week criterion, or 3.75 R per quarter), but this limit could be received in a single exposure, if no additional exposure to radiation occurred during that month.

A third limit was in effect for accidents or for individuals not regularly exposed to ionizing radiation. The "emergency" MPE was 5 R for one exposure if a total exposure of 15 R per year was not exceeded.

Before World War II, the Advisory Committee on X-Ray and Radium Protection, which in 1946 became the National Committee on Radiation Protection (NCRP), recommended a limit of 0.1 R per day for whole-body exposure for radiation workers. This criterion was used by the wartime Manhattan Project (A.6, p. 43). At that time, no evidence existed that individuals chronically exposed to this level were injured by radiation, and it was speculated that a "threshold" might exist, below which no injury could occur. Three years before Operation IVY, the NCRP recommended limit was reduced by one-half from 0.1 R per day to 0.05 R per day, not because the older value was found to be unsafe, but because the radiation to which people were being exposed in the atomic

* Regulations from NavMed P-1325, Radiological Safety Regulation, of 1951 are cited here (Reference A.7).

weapons research program was more penetrating than the medium-energy X-rays on which the older value was established. The 0.05 R per day (equal to 0.3 R per 6-day week; 0.35 R per 7-day week) was the maximum permissible exposure, to be measured at the depth of bone marrow. The IVY history (Reference C.0.1, p. 226) indicates that the allowable exposure of 3 R was for a 3-month period, or 12 R per year.

The JTF 132 report, Radiological Safety (Reference C.1.7.1), details the MPLs used. The MPLs were identical to the U.S. Navy standards (NavMed P-1325). Radiological Safety states:

Permissible contamination levels stated below are to be regarded as advisory limits for the general guidance of Rad-Safe Personnel attempting control of contamination under average conditions. These limits may be adjusted upward or downward under special circumstances, as directed by CTG 132.1.

All readings of contamination levels are to be made with side-window G-M counters, the counter tube walls of which are not substantially in excess of 30 mg/cm² with the beta shield open. When possible the surface of the probe should be held 1 to 6 in. from the surface under observation. The larger distance is preferable for preliminary survey; the smaller distance is preferable for detailed survey of maximum contamination areas.

Personnel and Clothing

Skin: Complete decontamination by bathing is to be attempted. If a reading in excess of 1 mr/hr is obtained after repeated washings, the decontamination supervisor will be consulted for appropriate advice.

Underclothing and Body-contact Equipment (Interior Linings of Boots and Respirators): The permissible limit is 2 mr/hr.

Outer Clothing and Body-proximity Equipment (Outer Surface of Boots and Protective Clothing): The permissible limit is 7 mr/hr.

Aircraft, Vehicles, and Small Boats

The permissible limits are as follows: interior surfaces, 2 mr/hr; exterior surfaces, 7 mr/hr; and distant exterior surfaces, 20 mr/hr.

Air and Water

The following continuous levels of radioisotope content in air and water are generally considered to be safe:

	Beta or gamma emitter	Alpha emitter
Air	10^{-9} $\mu\text{C}/\text{cc}^*$	5×10^{-12} $\mu\text{C}/\text{cc}$
Water	10^{-7} $\mu\text{C}/\text{cc}$	10^{-7} $\mu\text{C}/\text{cc}$

The contamination levels in air and water currently are measured in units of $\mu\text{Ci}/\text{cm}^3$ (microcurie per cubic centimeter). A curie is a measure of radioactivity (3.7×10^{10} disintegrations per second). Thus, for example, the maximum beta or gamma radioactivity permitted per cubic centimeter of air was 3.7×10^{-5} disintegration per second. The relationship of this number to exposure in roentgens depends upon the particular radionuclide, or mixture of radionuclides, since each may emit a different gamma photon energy.

As details of the cloud-sampling requirements became known, assurance of pilot safety in the F-84G cloud samplers continued to be a concern. Plans relative to permissible exposures for personnel participating in IVY had been based on the exposure of 3 R (measured gamma only) over a 3-month operational period. This limitation posed a serious problem in planning reasonable flexibility for the cloud-sampling operations because it was difficult to predict the exposures that might be incurred by the sampler pilots. At an informal meeting in the Division of Biology and Medicine, AEC, on 21 May 1952, it was concluded that the AEC would be receptive to a proposal from CJTF 132 to establish a special emergency exposure of 20 R, subject to several restrictions, for Operation IVY (Reference C.0.1, p. 226).

Because a one-time 20-R exposure would bar pilots from future tests, the AEC recommended that concurrence first be obtained from the Surgeon General, Headquarters, USAF. Therefore, on 29 May 1952, CJTF 132 requested the Air Force Surgeon General to submit his comments on the proposal. On 31 July 1952, in an endorsement to the basic communication, the Surgeon General indicated agreement with the opinion that no permanent physiological damage to individuals would result from a one-time exposure of 20 R. That office was of the opinion that the decision to allow the 20-R exposure could be a command

* The abbreviation "c" was commonly used in 1952 to represent "curie;" the currently used abbreviation is Ci. Similarly, "cc" means "cubic centimeter;" cm^3 is currently used.

decision and that a nominal modification of existing standards was unnecessary (Reference C.0.1, p. 226).

Early in June 1952, in a letter from JTF 132 headquarters to the School of Aviation Medicine, Randolph AFB (Reference C.4.6), some findings of a 13 May 1952 meeting with LASL scientists were presented. LASL estimated that sampler aircraft pilots, if completely unprotected, could receive an exposure of 100 to 125 R. A reduction to between 3.1 and 3.9 R was postulated for five half-thicknesses of absorbing material, or about 1 mm (0.039 inch) of lead. On 3 July 1952, a meeting at the AEC, Washington, D.C. was held to determine the necessity for and feasibility of providing protection against the radiation expected to be encountered by sampler pilots in the MIKE shot. Representatives of the AEC Division of Biology and Medicine, LASL, and the Air Force were present. General conclusions of the meeting were as follows (Reference B.4.9):

1. A two-fold increase in the size of sample collected per pilot would be permitted with 0.5 mm (0.020 inch) of lead protection
2. Sampling operations would be conducted on the basis of a 5-R planned dose to the pilot. An accident or unforeseen circumstance would not result in doses greater than 10 R
3. With specific limitations on reexposure, sampling pilots would be authorized to receive 20 R
4. No eye hazard was anticipated during MIKE sampling; a lead-glass visor was considered desirable from a psychological viewpoint
5. Body extremities presented no primary radiation concern
6. Protective materials equivalent to 0.5 mm (0.020 inch) of lead would be used in a manner operationally suitable to the sampler aircraft organizational commander.

The meeting led to the development and use of special protective clothing and lead-glass visors for sampler pilots.

A letter sent by CJTF 132 to the Director, Division of Biology and Medicine, AEC, proposed that a special, safe emergency exposure be permitted under the rad-safe regulations governing Operation IVY to allow a 20-R integrated exposure (measured gamma only), subject to the following conditions (Reference C.0.1, p. 226):

1. Personnel in the special category of the allowable 20-R exposure would be the pilots of the F-84G sampler aircraft
2. Personnel in the special category would be allowed a total exposure of 20 R for the entire Operation IVY
3. Personnel who received the maximum of 20 R would not be reexposed to a similar "one-shot" exposure of this extent for at least 2 years; this was not to preclude additional exposures on a lifetime basis of 0.3 R per week
4. Suitable medical records of such individuals would be maintained in their parent agencies to reflect the exposures to ensure compliance with the 20-R restrictions
5. Personnel expected to be in the 20-R category would be given the special rad-safe physical examination before exposure and at least once per year for 2 years after the exposure period
6. Results of medical examinations would be reported by the respective Department of Defense (DOD) services, or sponsoring agency if nonmilitary, to the AEC with suitable identifying data to maintain a central repository for exposure records of all personnel involved in atomic tests of the AEC.

Although early verbal approval of the AEC was received, it was not until 29 August that CJTF 132 received formal approval from the AEC to permit the 20-R exposure. This letter modified the proposals in the task force commander's letter to permit an upper limit of 25 R and recommended that pilots receiving the total allowable exposure not be used in subsequent operations involving more than normal permissible exposures to radiation unless their services were needed to avert an imminent threat to national security (Reference C.0.1, p. 226).

At least one other special limit may have been established. The TG 132.4 Weather Reconnaissance Element used an exposure rate of 9 R/hr as the maximum permitted for its airborne WB-29s (Reference B.4.6, Annex H).

The following quote from NavMed P-1325, Radiological Safety Regulations (Reference A.7), is representative of, at least, medical opinion about ionizing radiation at the time of Operation IVY.

Although the term "tolerance" is used in reference to dosage of radiation, there is no proof that living tissues are completely tolerant to ionizing radiation even in the

minute amounts everywhere present as normal background radiation (cosmic rays, radon, et cetera). The term "Maximum Permissible Exposure" is a better term. Accordingly, the word "tolerance" will be replaced by the term "Maximum Permissible Exposure (MPE) [emphasis added].

The MPE's do not represent limits within which there can be a complete disregard of exposure. (The exposure to ionizing radiation should be kept to an absolute minimum in all circumstances.) [emphasis added]

Radsafe Instrumentation

Most of the TU 132.1.7 monitoring was done with the AN/PDR-T1B ion chamber. Fifty-five of these instruments were on loan from the Armed Forces Special Weapons Project (AFSWP). The instrument electronics had been modified at the NPG to eliminate switching transients resulting from changes in scale. A new ion-chamber instrument developed by the Army Signal Corps, IM-71/PD(XE-1), called the "Jasper," was tested and used after humidity leaks were corrected. Twenty-five of these instruments were available to the task force. A letter to CTG 132.4 indicated that "for some instruments" the meter needle would not return to zero when subjected to high temperature. This would not affect the reading above 1 R/hr but could cause some inaccuracies in the lower ranges. Personnel monitoring was done with the Beckman MX-5 and AN/PDR-27C Geiger-Mueller instruments (Reference C.1.3.614). Table 15 lists the instruments used by TG 132.3.

To protect ships and small craft from contamination by radioactive material in lagoon waters, periodic samples were collected from the lagoon, analyzed in the laboratory van aboard Rendova, and, in the event contamination was indicated, CTG 132.3 was notified (Reference C.1.3.614, p. 31).

Two instruments were considered for aircraft installation to determine TG 132.4 pilot exposures. They were the Proteximeter, developed by Victoreen, and an integrating dosimeter, the Integron, developed by LASL. Due to the limited time for procurement of the instruments and the considerable modification requirements for the Proteximeter, it was decided in March that the LASL Integron would be used on the F-84G cloud sampler aircraft. It was redesigned to meet space requirements, and the prototype was received by TG 132.4 on 14 April. Twenty instruments were manufactured. Five of these instruments

Table 15. Task Group 132.3 allowance for radiaic equipment, IVV.

Unit Type	AN/PDR-T1B High-Range Survey Meter	Low-Range Survey Meter ^a	Alpha Survey Meter	IM/91PD 0-200 mR Dosimeter	IM/19/PDOR or IM/20/PD High-Range Dosimeters	PD-311-A Battery Dosimeter Charger	PD-354-D/PD Electrostatic Charger
AGC	12	6	2	6	12	1	2
CVE	24	12	2	12	24 ^b	2	3
DD	12	6	2	6	12	1	2
LSU	2	2	0	2	5	1	2
LSD	4	2	0	2	6	1	2
LST	2	2	0	2	5	1	2
AP	5	3	0	3	10	1	2
AV	6	3	0	3	8	1	2
P2V Squadron ^c	16	16	0	16	16 ^b	1	2
PBM Squadron ^c	2	2	0	2	2	1	2
Boat Pool ^c	6	3	0	6	6	1	2

Notes:

^aAN/PDR-27C and Beckman MX-5.

^bProbably available for these units only.

^cNot standard allowance; changed to fit operation.

were placed in F-84G cloud sampler training aircraft at Indian Springs, Nevada, 21 April, and tests proved them to be very satisfactory during Operation TUMBLER-SNAPPER.

An Operation IVY radsafe requirement to record gamma intensity under water necessitated procurement of special meters. This requirement was placed in April 1952 by the Deputy Commander of TG 132.1, who was of the opinion that the shallow parts of the reef near the shot island would be activated by slow neutrons from MIKE. He felt that the blast wave would clear the water from the reef and the slow neutrons that would be present in large quantities for about 10 seconds would then activate the temporarily exposed reef. In a matter of 3 or 4 days, the water in this area would be decontaminated by the normal flow of currents to the ocean, but the reef itself could remain fairly radioactive. If it became necessary for recovery parties to stand in the water in this area, the normal beta- or gamma-intensity-reading meters would indicate little reef contamination, if present, due to the shield of water. Hence, it was believed prudent to procure these special meters (Reference C.1.2, Sep Inst).

Personnel self-reading pocket dosimeters of at least three different ranges were used: 0.2 R (IM/91PD), 10 R (IM/19PD), and 100 R (IM/20PD). No indication of the accuracy of these instruments has been found.

Film Badges

Personnel dosimetry was determined from a combination of film badges and pocket dosimeters. Altogether, 5,000 film badges were utilized and processed during Operation IVY (Reference 1.7.1, p. 30). The intent of the badging program was to issue badges only to those people who might enter contaminated areas or be exposed to fallout.

Badges were issued and processed by the Photodosimetry Section of TU 132.1.7. The monitor assigned to each recovery or work party obtained film badges and recipient recording forms for the entire party from TG 132.1. Badges were issued daily for each party entering the radex area. Other exchange periods may have been used for other groups.

The standard film badge was a DuPont 558 containing one piece of No. 508 emulsion (range 0.015 R to 6 R) and one piece of No. 1290 emulsion (range 5 to 750 R) with a 20-mil- (0.51 mm) thick lead strap, 1/2-inch- (1.27 cm) wide covering about half the length of the packet on both sides. The lead was held on the paper-wrapped packet by an adhesive. The entire packet was enclosed in a heat-sealed envelope of 2-mil (0.051-mm) polyethylene. Each badge had an embossed serial number (Reference C.1.7.1).

An additional badge was worn by the sampler aircraft pilots. The films were No. 502 (reasonably accurate between 0.1 R and 3.0 R and usable to about 10 R), No. 510 (5 to 50 R), and No. 606 (10 to 300 R) in a DuPont No. 553 packet. Two types of holders for the packet were used: the LASL holder made of 20-mil (0.51-mm) sheet brass with openings on both sides, one exposed to the air and one covered with 20-mil (0.51-mm) cadmium; and the National Bureau of Standards holder which completely encased the film in layers of bakelite, tin, and lead. These films were identified by X-rayed numbers (Reference C.1.7.1, p. 79). The highest value recorded by any one of the badges worn by an individual was used in compiling the exposure records.

The personnel data exposure sheet used for issuing and receiving purposes contained the following information:

1. Date of issue
2. Film badge number
3. Name of person issued to
4. Name of person wearing badge
5. Project number
6. Wearer's home station
7. Date returned
8. Dosimeter number
9. Dosimeter reading.

The films were processed on Parry Island by TU 132.1.7, although there were plans to use a photo trailer on Rendova also. However, this was apparently not used (Reference C.3.11). Individual exposure records were kept on 5x8 cards containing the following information:

1. Name
2. Project
3. Home station
4. Date
5. Badge number
6. Exposure
7. Accumulated exposure
8. Dosimeter reading.

These cards form the basis of the exposure records summarized in the Consolidated List (Reference C.1.7.2) used as a standard reference in this report for personnel exposures. The file of the 5x8 cards themselves has been micro-filmed, and the microfilm file has also been used as a reference tool in preparing this report. It is cited as Personnel Radiation Exposure Record -- Microfilm (Reference C.1.7.3).

Daily reports of the accumulated exposure of monitors, helicopter pilots, and persons whose exposure exceeded 2 R were made (Reference C.1.7.1, p. 82). These reports were informally provided to the Control Group each morning so that appropriate duty assignments could be made (Reference C.1.7.5).

MAJOR EQUIPMENT MODIFICATION

Before the tests, task force ships and some aircraft were modified to reduce the potential for radiation exposure of the crews.

Ship Modification

To protect the surface units of TG 132.3 against fallout contamination, the Navy Bureau of Ships (BuShips) designed temporary washdown systems for installation on each ship. If fallout were detected, all topside openings were to be closed, the ventilation system shut down, and the washdown system started. The theory of the washdown system was that by covering the entire vessel with a spray of relatively uncontaminated seawater, descending fallout particles would not lodge in topside gutters or the pores of wood or paint surfaces, and the particles would be washed overboard. System components were procured by the Naval Radiological Defense Laboratory and shipped to the Pacific Proving Ground (PPG) for installation. Two civilian engineers from BuShips

assisted the crews with installation and checkout. Systems were installed and tested on all ships 3 days before MIKE (Reference C.3.7).

Before each shot all ships were directed to use low-range radiation survey meters to note the background radioactivity at several topside locations. The survey was to be repeated at frequent intervals for "about a week" after the detonation. If any indication of fallout was noted, the washdown systems were to be started and operated until the survey instruments indicated the fallout had ceased, or the vessel was clear of the fallout area (Reference B.3.1).

Aircraft Modification

In contrast to previous Pacific tests, IVY cloud sampling (for Project 1.3) involved manned aircraft penetrating the clouds produced by KING and MIKE. Two B-29s served as airborne navigation control (NAVAID) platforms for the samplers. A third aircraft, an RB-36H, served as flight controller for aircraft penetrating the cloud. In addition, several KB-29 tanker aircraft were used to refuel F-84G sampler aircraft because of the distance between their base at Kwajalein and the shot locations at Enewetak Atoll. Some weather reconnaissance WB-29s were also equipped for cloud sampling.

Planning for high-altitude cloud sampling was undertaken in 1951 by LASL and AFSWC. Several types of aircraft, including B-36, B-47, B-45, F-89, and F-84 models were considered for suitability. In early 1952, a decision was made to employ the F-84G single-place fighter-bomber. (The decision, however, added a task to the list of TG 132.4 requirements to plan for inflight refueling.) The F-84G had an ejection seat, anti-G suit provisions, windshield defroster system, automatic fuel transfer system, and an inflight refueling system. First accepted by the Air Force in June 1951, it was considered a first-line combat aircraft.

Beginning with the early planning phases, considerable thought was given to radsafe measures that would be required for the sampler aircraft. Planned pilot protection included filters in the cabin pressurization system to remove radioactive particles from the air taken into the aircraft, a pilot-visible rate meter and an integrating dosimeter to allow the pilot to judge his total exposure, and radiation shielding to protect him. Sixteen aircraft were specially modified for IVY sampling operations under the supervision of the Air

Materiel Command (Reference A.4, p. 66). Major modifications to these F-84G aircraft included four avionics systems: an ARA-8 homing device, an ARC-3 VHF radio transceiver, an AN/APX-6 IFF (Identification Friend or Foe) transponder, and an F-5 autopilot (see Figure 13). Dual-cloud-sampling systems were also included.

A preliminary inspection of an F-84G aircraft had revealed that the cockpit did not have sufficient space for installation of filters at the terminals of the pressurization system. Subsequent studies indicated that a filter could be placed in the pressurization line forward of the intercooler-regulator "Y" connection or in the defroster line, which was an independent system located under the windshield of the cockpit. A trial installation was made on the F-84Gs scheduled for IVY that were being used in Nevada for TUMBLER-SNAPPER. Later, the TAU requested that a filtering unit be installed in the aircraft

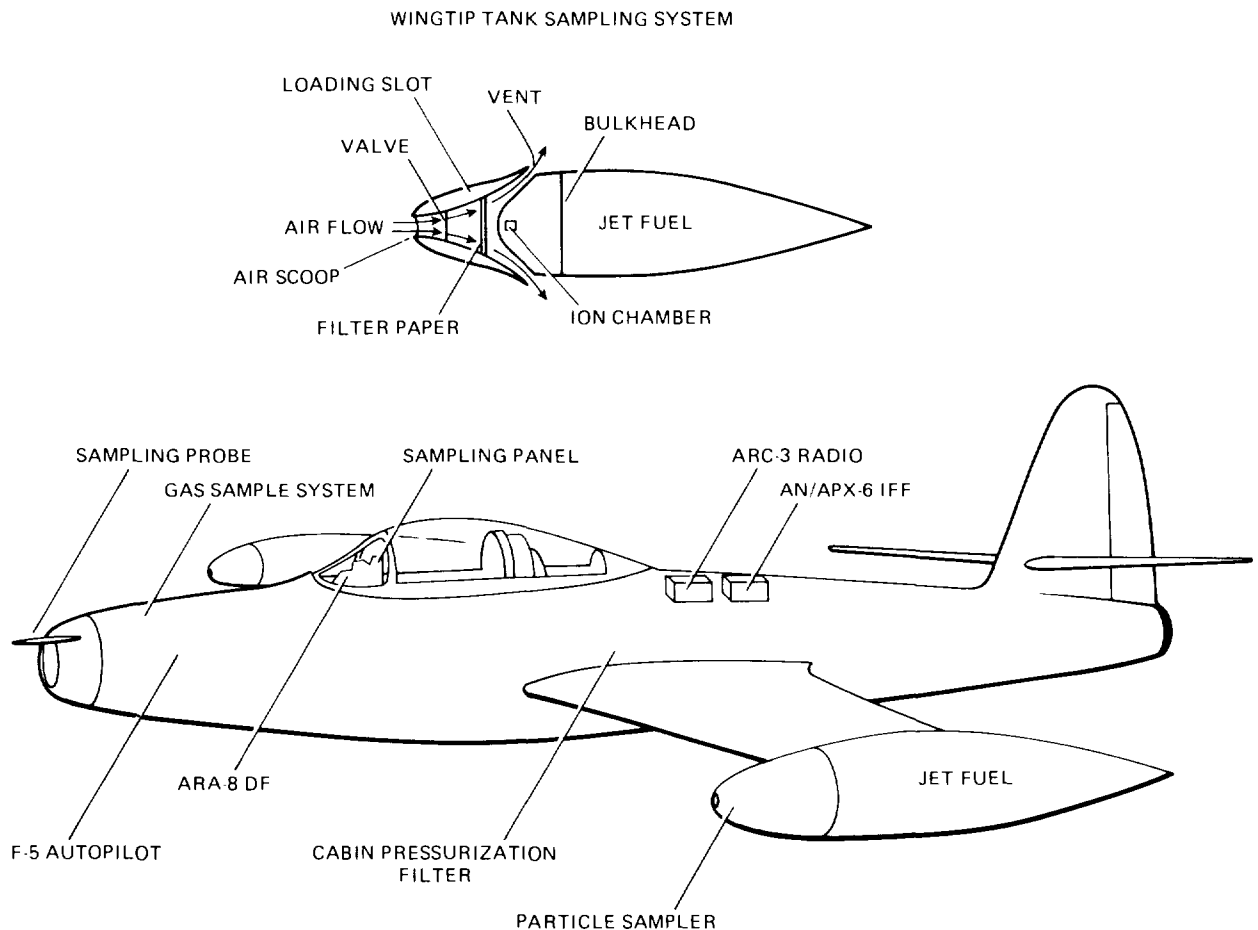

Figure 13. F-84G sampler aircraft.

oxygen system. The proposal met with objections as being unnecessary because pilots were to breathe 100 percent oxygen during the actual sampling operations and return to base. Difficulties were also experienced with the paper being used in the filters installed in the cabin pressurization system. The F-84G filtering problem was resolved when improved and thinner paper was chosen and installed in the pressurization filtering system. This increased the protection against contamination of air in the cockpit and the air that would be inhaled by the pilots (Reference C.0.1, p. 223).

One of the two types of sampling systems installed on the F-84Gs was called a "snap-bag." This consisted of a plastic bag mounted on the gundeck of the aircraft nose. The system was actuated by a trigger switch on the control stick, which enabled collection of gaseous samples through a sampling probe on the aircraft nose for 10 to 20 seconds. The second sampling system involved modifications to the wingtip fuel tanks to collect particulate matter from the nuclear clouds. A diagram of this wingtip system is shown in the inset of Figure 13. Operation was fairly simple; the pilot could open the valve behind the air scoop to admit air through the scoop. This air passed through filter paper, where particulate matter was collected, and then was vented. An ion chamber was mounted in the tiptank as a sensor to measure radioactivity of the filter paper, thus providing an indication of the amount of sample collected at any given time.

The F-84Gs were equipped with a sampling panel mounted atop the main instrument panel. The sampling panel is shown in Figure 14. This panel contained radiac instruments and indicator lights for each sampling system. The rate meter for the tiptank ion chamber had a three-stage scale: 0-1 R, 0-10 R, or 0-100 R. The reading from this meter was transmitted by the pilot to the sampler control aircraft where the sampling project manager maintained control of each mission.

The top center of the sampling panel had an integrating dosimeter (Integron). The meter recorded the total cockpit exposure during a sampling mission in the range of 0-7.5 R with an error of ± 20 percent. The IM-71/PD (Jasper) rate meter measured cockpit intensity. This instrument was manufactured by the Evans Signal Laboratory for the AEC and had a range of 0.005 to 800 R/hr.

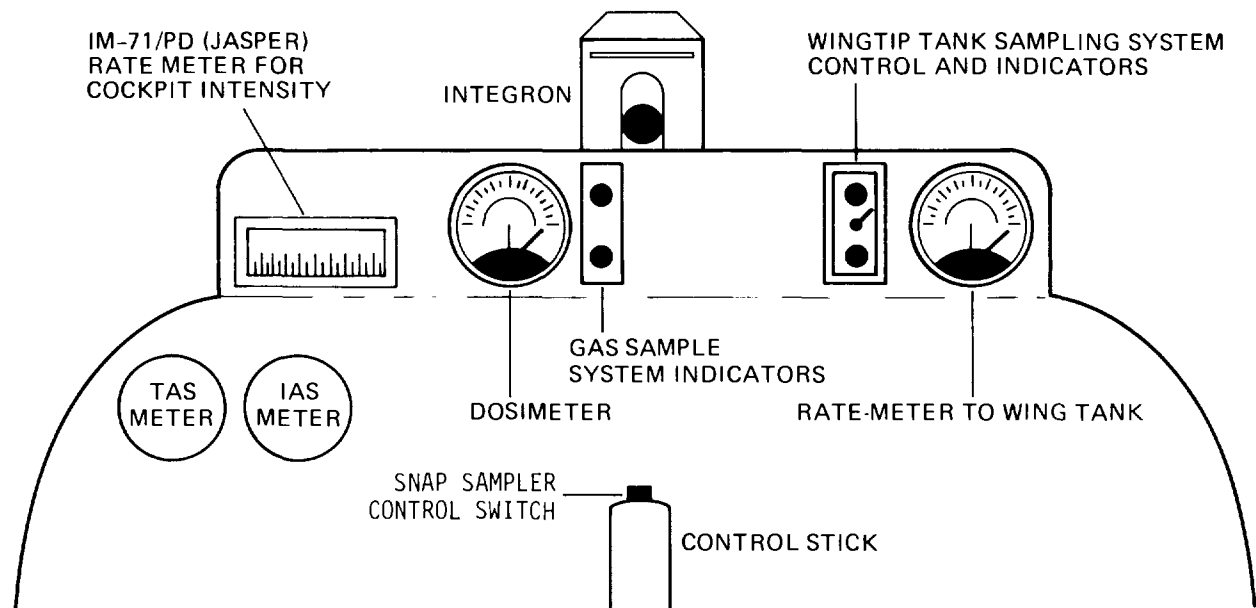

Figure 14. F-84G sampling panel.

Five of the F-84Gs that were modified for the sampling operation participated (without obtaining actual samples) in the TUMBLER-SNAPPER test series being conducted at the NPG. This participation was designed to give the pilots operational experience in a radioactive cloud and to verify the aircraft radsafe modifications.

An additional safety measure for the pilots was protective clothing. TG 132.1 performed calculations that indicated that the equivalent of 0.5 mm (19.5 mils) of lead around a pilot's trunk would allow the sampler aircraft to double the time spent in the cloud for a given exposure rate (Reference C.0.1, p. 223). A number of shielding suggestions were made:

1. Flying suit of several plies of lead-glass fabric or a suit of vinyl (0.5 mm [19.5 mils] lead equivalent) sandwiched between ordinary or lead-glass cloth
2. Wraparound insert to parachute using lead-impregnated vinyl or rubber or lead-glass fabric
3. Loose shroud or wraparound apron of above materials to be worn over the normal flying clothing
4. Lead sheet, or other materials, placed in pockets over vital parts of the body.

The method selected was a loose shroud of lead-glass fabric, eight plies thick. It fit over the head, draped down the back and extended over the sides and front to just below the knees. It was fitted with quick release snaps for rapid removal in the event of bailout. The shroud was field-tested in the TG 132.4 IVY rehearsal, Operation Texan (Reference C.O.1, p. 225). Figure 15 shows a protective shroud being placed over a sampler pilot. An additional safety measure taken before sampling operations was hand-polishing aircraft surfaces so that fewer radioactive particles would cling to them.



Figure 15. Protective lead-glass cloth shroud being placed on sampler pilot, IVY.

The 57th Weather Reconnaissance Squadron requested filter units for two cloud-tracking WB-29s. Blueprints for a filter unit were forwarded on 6 August 1952, by TG 132.4 (Reference C.4.4, Sep Inst, pp. 45-46). On 3 September, the 57th requested information on the manufacture and installation of filters in the cabin pressurization system of the WB-29s. The 4925th Test Support Group sent two filters to the 57th, and on 13 September they received authority from

Air Materiel Command for their modification and installation (Reference C.4.4, Sep Inst, pp. 54-60).

Cloud-sampling in Operation IVY was actually a joint venture between LASL and Hq USAF. Samples obtained by the F-84Gs were shared between LASL and Hq USAF, while Hq USAF supplemented its program by using Air Weather Service WB-29 aircraft. Ten WB-29 aircraft were equipped to collect particle samples on filter paper at around 20,000 feet (6 km). At Kwajalein, Hq USAF established and operated a complete counting room to determine the radioactivity of filter paper samples collected by the WB-29s (Reference B.1.1, p. 7.3.3).

Four of the WB-29s were also instrumented to detect airborne radiation instantaneously, as well as equipped with gas-sampling and water-collection devices. The gas-sampling equipment consisted of a compressor, fed by ram air, that forced the samples collected into cylinders. The system was designated as B/31 equipment. Airborne sampling operations of the WB-29s were conducted under the direction of a Hq USAF representative aboard the aircraft.

The selection of F-84Gs as sampler aircraft presented operational problems because they would have to operate beyond a point of no return, and had neither visual checkpoints nor radio ranging stations in the sampling area. Inflight refueling could solve one problem and airborne control points could solve the other. Aerial tankers were provided and two B-29s were modified to operate as airborne navigation control centers to vector the samplers and the tankers.

Each NAVAID B-29 was equipped with extra communication equipment. Three additional very-high-frequency (VHF) transceivers were added (for a total of four); a second high-frequency (HF) transceiver and a low-frequency (LF) transmitter were installed on each NAVAID B-29 so other aircraft could home on them using their radio compasses. An AN/APS-23 radar was installed with a modified AN/APX-6 IFF transponder that was capable of interrogating and identifying other aircraft. The 10-inch (25-cm) radar scopes permitted location plotting of other aircraft with an accuracy of ± 5 nmi (9.3 km) to a maximum range of 175 nmi (324 km). Some equipment normally aboard the B-29s was retained: Loran and radio compass, plus the AN/APQ-13 navigation radar. A large, clear plastic plotting board was located in the aft section across the entire fuselage so that a continuous air plot could be maintained of all aircraft with

respect to the NAVAID aircraft. Near the B-29 waist-gunner's positions were seats for three scientific observers to maintain visual observation of the cloud and sampler aircraft.

The 307th Air Refueling Squadron modified 10 KB-29 tankers by adding a low-frequency transmitter, so that samplers could home on them, and a modified AN/APX-6 IFF transponder for identification.

PRE-EVENT SAFETY

Pre-event safety measures included:

- Medical examinations consisting of chest x-rays, blood counts and differentials, and urinalyses were given to personnel who might be exposed to radioactivity during the tests.
- Clearly marking all radioactively contaminated areas of previous detonations at Enewetak Atoll. Personnel were prohibited from entering these areas, except by specific orders from CTG 132.2 or the Enewetak AEC representative.
- Rechecking and calibration of all radiac survey meters with a 22.8-mg radium source in October.
- Execution of a roll-call formation and practice evacuation by all task force elements on 25 October. All procedures were tested, and it was determined that the actual evacuation would not present any insurmountable obstacles.
- Dismantling, packing, and covering all hospital and dispensary equipment and supplies with canvas. All windows and doors were fastened open.
- Covering or sealing other equipment to prevent or reduce contamination. The covers also provided protection from the weather in case of extended absence from the island.

In addition, preshot planning included designation of a restricted zone around the shot atoll, prediction of the weather and fallout patterns, establishment of a radex area, preparation for offsite monitoring, modification of equipment for ease of decontamination, and evacuation of all personnel from Enewetak Atoll for the MIKE shot.

Security Perimeter

A security perimeter was established in which entry was prohibited. This was a de facto radiation exclusion area. The trusteeship agreements between the United States and the United Nations, which established the Trust Territory

of the Pacific Islands of which Enewetak was a part, provided that the United States could close any portion of the area for security reasons. On 2 December 1947, the United States officially closed the area of Enewetak and its adjacent territorial waters at a distance of 3 nmi (5.6 km) on the ocean sides of the atoll (Reference C.0.1, pp. 167). The following year the U.S. Department of State concurred with the DOD and the AEC in the establishment, for an indefinite period, of a danger zone around the atoll. This zone included an area of 150 by 200 nmi (278 by 370 km), centering on the atoll and bounded by the parallels $10^{\circ}15'N$ and $12^{\circ}45'N$ and meridians $160^{\circ}35'E$ and $163^{\circ}55'E$. These boundaries were published in the U.S. Navy Hydrographic Office publications, "Notices to Airmen" and "Notices to Mariners."

Weather and Fallout Prediction

The direction and extent of fallout were recognized as being largely dependent on the structure of the upper winds (Reference C.0.1, p. 207). Consequently, upper atmosphere meteorological soundings were used before each shot to determine if the radioactive debris would move toward inhabited areas. Forecasts were also made daily of the Marshall Islands vicinity weather to assist ships and aircraft in preshot buildup operations and preparations; especially important were predictions of visibility and rainsquall activity for aircraft flying between atolls. Finally, a weather watch was maintained to ensure that no unexpected tropical storms advanced on JTF 132. Since only five permanent weather stations existed in an area larger than the continental United States, additional weather data were gathered from JTF 132 ships, various military stations in the Pacific, weather stations established by JTF 132, and routine weather reports by transient shipping in the general area.

TG 132.4 was assigned the weather-gathering and -prediction responsibility. Two elements within the TSU (TU 132.4.3) were primarily involved: a Weather Reporting Element and a Weather Reconnaissance Element. A Weather Central Office was established at Enewetak Island on 25 September 1952 to coordinate the weather activities and make the forecasts.

The Weather Reporting Element was organized, manned, and trained by the 2059th Air Weather Wing, Tinker AFB, Oklahoma. The 2059th, in turn, placed the basic responsibility on the 2060th Mobile Weather Squadron (later the 6th

Weather Squadron, Mobile) (Reference C.4.8) of maintaining and operating four new weather stations on outlying atolls, the element's headquarters at Kwajalein, and Enewetak Weather Central (Reference C.0.1, p. 209).

Weather stations were established on Ponape, Kusaie, Majuro, and Bikini. Each was manned by one officer and approximately twenty enlisted men. These outlying stations were responsible for making surface and upper-air observations and transmitting reports to Weather Central. Normal operations required surface observations every 3 hours and radar wind soundings (rawinsonde) observations twice each day. During immediate pre- and postshot periods, a minimum of four rawinsondes were required each day.

The Reconnaissance Element, based at Kwajalein, was organized under the 57th Reconnaissance Squadron at Hickam AFB, to which 56 officers, 253 airmen, and 10 WB-29 aircraft were assigned. The element moved to Kwajalein in October 1952 (Reference C.0.1, p. 208). This squadron had previously performed weather reconnaissance operations during Operation GREENHOUSE.

The element had the following responsibilities (Reference B.4.2):

1. Conduct two weather missions each day of approximately 12 hours duration, commencing on first shot minus 20 days
2. Conduct three weather missions each day of approximately 12 hours duration, commencing on first shot minus 4 days
3. Conduct postshot radsafe missions, consisting of two missions each day of approximately 12 hours duration, from D-day until D+2.
4. Beginning on 10 October 1952, assume typhoon reconnaissance responsibility in the area bounded by the equator, latitude 25°N, and the meridian of 180°, longitude 157°30'E.

Weather Central on Enewetak issued daily instructions on the particular reconnaissance tracks (termed Petrel tracks) to be flown. Nearly 1,000 flying hours were logged in the Petrel flights (Reference C.0.1, p. 209).

At peak strength Weather Central was manned by nine Air Force officer forecasters, one airman forecaster, seven airman observers, four Navy officer forecasters, and ten Navy enlisted observers. These personnel were in addition to the permanent Air Force Upper Air Weather Detachment at Enewetak.

Before Operation IVY, six of the Air Force forecasters studied methods of forecasting the Marshall Islands weather at the University of California, Los Angeles.

Data collected by Weather Central included weather reconnaissance reports, surface reports, upper-air reports, position operational meteorological aircraft reports (POMAR), terminal forecasts, storm bulletins, map analyses, zonal wind data, and various miscellaneous reports. Facsimile-transmitted weather maps were received from Washington, D.C.

The surface weather map was analyzed four times daily at 0500, 1100, 1700, and 2300 and covered an area extending from 60°N to 20°S latitude and 95°E to 120°W longitude. Streamline charts were prepared four times daily for altitudes of 1,500, 10,000, 20,000, 30,000, 40,000, 50,000 and 60,000 feet (0.46, 3.05, 6.10, 8.14, 12.19, 15.24, and 18.29 km). The area covered was bounded by 30°N , 5°S , 140°E , and 170°W . In addition, at 0200 and 1400, synoptic charts were prepared for 200-, 300-, 500-, and 700-millibar (20-, 30-, 50-, and 70-kilopascal) contours over the entire Pacific Ocean. This helped in understanding the overall pattern of pressure and winds in the middle and high latitudes as compared with those of the tropics.

The routine daily operation of Weather Central differed considerably from that immediately before shots, primarily in the operation of the analysis section. All of the aforementioned reports and charts were critically analyzed, and a forecast of winds at 2,000-foot (0.61-km) intervals to 20,000 feet (6.10 km) and 5,000-foot (1.52-km) intervals to 70,000 feet (21.33 km) was issued three times daily to prepare and practice for shot times. Daily forecasts issued for aircraft operations included forecasts of winds, clouds, and weather between Enewetak and Kwajalein. The winds, clouds, and weather downwind from Enewetak at 40,000 feet (12.19 km) were also included. The entire operations program for the month before the MIKE shot was designed to familiarize personnel of Weather Central with all phases of analysis and forecasting to assure a smoothly operating unit during the critical preshot forecast periods at shot times.

From 13 October through 24 October, extensive cross-training and checking of communications was conducted aboard Estes where Weather Central would be

located during the evacuation and afloat period for MIKE. On 25 October, personnel who were to man Weather Central afloat began moving aboard Estes. Personnel scheduled for evacuation to Kwajalein before the MIKE shot continued to operate Weather Central ashore until the morning of 28 October when Estes Weather Central assumed control. On the same day, 17 officers and enlisted men of Enewetak Weather Central were evacuated to Kwajalein to augment the personnel and operations of the Kwajalein weather station.

Preparations for the necessary analyses and forecasts for shot time were begun 2 days before the MIKE detonation. In addition to the current streamline analyses, 24- and 48-hour predictive streamline charts were prepared for all levels from 1,500 to 60,000 feet (0.46 to 18.29 km). Preparation of the predictive charts was considered the most important phase of the entire forecasting operation since it was from this source that all wind forecasts and prediction of postshot trajectory of airborne particles and debris were made.

Trajectory and streamline charts were used as the basis of the fallout forecast, which defined the radex areas. No information has been found that indicates the extent to which fallout forecasts were used in preshot briefings. Modeling of fallout phenomena was a new technique, and only qualitative predictions were possible, that is, the midline and lateral extent of the pattern could be estimated, but no quantitative prediction of fallout amount or fallout rate was available (Reference A.8).

A fallout prediction for the MIKE shot was made for scientific Project 5.4a and indicates the level of prediction available for Operation IVY (Reference C.1.3.615, p. 51):

. . . [One] analysis satisfactorily explains the mechanism of fall-out, except for the area immediately surrounding ground zero at Operation IVY.

. . . [Another] theory . . . accounts for the phenomenology of the fall-out in the area in the immediate vicinity of ground zero.

It is believed that these theories in their respective areas accounted for the fall-out phenomena accurately at Operation Ivy.

That some luck was involved in the IVY weather was recognized (Reference C.0.1, p. 218):

In summary, the weather problem encountered during Operation IVY was felt by the meteorologists concerned to have been one of the most difficult in the history of meteorology. The total requirement for weather; the absolute demands with respect to terminal conditions at both Kwajalein and Eniwetok plus the air route between these terminals; and the rigorous conditions of minimum acceptability of upper wind structure controlling radioactive fall-out throughout the Marshall Islands all combined to create a problem which bore only a remote probability of satisfying all conditions simultaneously. The fact that the problem was successfully resolved should not be permitted to obscure one very important fact of fate -- MIKE was detonated on the date scheduled several months earlier and this date was, providentially, the only day during a period of approximately one month when acceptable conditions prevailed. Unacceptable conditions had existed for fourteen days preceding and nine days after 1 November, and the KING detonation was no less complicated due to the added condition for a visual drop.

Radiation Exclusion Area

Delimitation of the radiation exclusion, or radex, area was a responsibility of TG 132.4. Criteria governing the radex area have not been found. The final radex area for MIKE was developed about 7 hours before the shot and was used in briefing the aircraft crews. This radex area was based on the forecast H+3 winds and gave cloud formation data up to 60,000 feet (18.30 km) (Reference C.4.4, MIKE Inst, pp. 26-27). Subsequent air radex areas were prepared from the data provided by the sampler and cloud-tracking aircraft. No specifics of the air radex area for the KING shot have been found except that it was prepared and covered the southeast sector of the PPG (Reference C.1.3.608).

Offsite Safety and Monitoring

Consideration of the safety of non-task-force civilian populations occurred early in radsafe planning (Reference C.0.1, p. 228). The safety measures adopted for the operation included preshot evacuation of the Marshall Island inhabitants closest to the detonation, measurement of the fallout produced by the detonation at inhabited islands in the Pacific and at a worldwide network

of fallout-recording stations, and analyses of drinking water at nearby atolls for radioactivity.

Before IVY, AEC NYKOPO had established a study known as the "Worldwide Fallout Monitoring Program" (Reference C.0.1, p. 224). This program evaluated the magnitude of fallout at long distances from the detonation site by collecting radioactive debris, which was analyzed in New York.

The original NYKOPO plan was for sampling the area beyond 500 nmi (927 km) from Enewetak; JTF 132 was to monitor the islands within this distance. In early September 1952, the NYKOPO assignment was extended to include all of the islands of the Trust Territory except Enewetak itself (Reference D.1).

The NYKOPO monitoring activity included aerial survey and collection of fallout on gummed paper and by filters. The Navy provided the aircraft for aerial monitoring. Instruments aboard the aircraft were used to determine if fallout had contaminated the area below; and when positive readings were received, landings were made, if possible, to obtain samples. The survey was conducted from D+1 to D+7. Flights originated from Kwajalein, Guam, and Honolulu. After the MIKE shot, aerial radiation surveys were made of the Hawaiian Islands, the Marshalls, Carolines, Marianas, the Japanese islands of Honshu, Shikoku and Kyushu, and the Ryukyu Islands (Okinawa, etc.). Following KING, a less extensive survey limited to the Marshalls, the eastern Carolines, and the Marianas was made (Reference D.1).

Particulate fallout was collected on gummed paper at 111 worldwide stations including Honolulu, Guam, Ponape, Truk, and Midway. The concentration of airborne radioactive particulates was measured at Kwajalein, Guam, Midway, and Honolulu. At these locations air-filtering equipment was turned on when the fallout cloud was known to be in the area. Automatic air-filtering stations, which were instrumented to begin operation when the external gamma exposure reached 0.0005 R/hr, were located at Kusaie, Ujelang, Bikini, Majuro, and Kwajalein. The radiation level required to start the equipment was not achieved in MIKE and the units were not reset for KING (Reference D.1, p. 1).

The drinking water at Enewetak, Kusaie, Majuro, Ponape, Kwajalein, and Bikini was tested by TU 132.1.7 after the MIKE shot. No detectable activity was found.

Evacuation

Radsafe plans required evacuation of all personnel from Enewetak Atoll for the MIKE shot. Early plans for evacuation of the atoll during KING were ultimately revised to evacuate only the islands north of Japtan and maintain the capability to evacuate all personnel from Parry and Enewetak islands if necessary. Early plans were for the MIKE firing party to remain ashore in a specially constructed bunker. This plan was cancelled because of the potential radiation exposure and the cost of bunker construction.

The people of Ujelang (who had been removed from Enewetak Atoll in 1947) and their domestic animals were also evacuated from Ujelang as a safety precaution for the MIKE shot. The evacuation was made by LST-827 on the afternoon of 27 October 1952 and the following morning.

CTU 132.1.7 detailed a radsafe engineer to oversee shipboard monitoring and to conduct ground surveys of Ujelang before the inhabitants debarked (Reference C.0.1). Because a rubber boat was not available, he had to swim from the ship's boat in the deep water of the lagoon to the shore and launch an outrigger to return to the boat and pick up monitoring instruments for the survey (Reference C.1.7.1, p. 27).

The ground survey followed the aerial sweep and was made on the morning of 2 November before the return of the people. No radioactivity was detected by either the aerial survey or ground monitoring of the area; the latter was conducted using an MX-5, a T1B, and a PDR-10A. Beta and gamma instruments were used to monitor the general living area, and an alpha detector was employed to check the water supply (rainwater collected in cisterns) and spot check the ground around the island. In addition, the radsafe engineer collected lagoon and freshwater samples and dirt samples; these were later examined by the TU 132.1.7 laboratory aboard Rendova. No activity above background was detected (Reference C.1.7.1, p. 27).

POSTEVENT SAFETY

General radsafe precautions that were applicable after the detonations are described under "Radiological Safety Planning" in this chapter (page 64).

Additionally, early-time surveys were planned to determine the extent of contamination, specify the time of atoll reentry, and the time at which the scientific project personnel would be allowed to recover samples on contaminated islands; decontamination procedures were established for men and equipment and regulations were made for the release of contaminated equipment from the restricted area or the PPG.

Early Radiation Surveys

Reentry and recovery schedules were prepared for both MIKE and KING. The MIKE survey was more critical because of the evacuation. Rapid reactivation of emergency facilities on the Enewetak Island airstrip was needed in case of an emergency landing. The advance planning was justified by an emergency landing of an F-84G. A list of personnel categories considered essential for early reentry to Enewetak included (Reference B.0.2, Annex U):

1. TG 132.4 personnel to operate aircraft emergency landing area at Enewetak
2. Radsafe monitors
3. Scientific personnel for collection of MIKE data
4. Scientific personnel for KING instrumentation
5. Key H&N personnel
6. Loran detachment
7. Documentary photo team
8. TG 132.1 command post group
9. Shore-to-ship communications detail
10. Helicopter pilots.

The first radiological survey after MIKE was made by TU 132.1.7 at H+2 by helicopter from Rendova. For KING the Marine helicopter left from Parry Island at H+30 minutes. The survey proceeded first to Parry Island and cleared the island for early reentry parties. The helicopter then proceeded north at about 10 knots (18.5 km/hr). The radioactivity on each island was measured from about a 25-foot (8-meter) altitude using an AN/PDR-T1B detector. The plan called for the helicopter to proceed until it reached an exposure rate of 3 R/hr. The helicopter, however, was contaminated by particulates carried by a rainsquall and returned to Rendova for decontamination.

CTG 132.4 directed TE 132.4.1.1 to furnish two H-19 helicopters to Rendova to supplement Navy and Marine helicopters for atoll reentry flights. The main purpose, however, was to provide transportation for early reentry to Enewetak airstrip of an emergency ground crew in the event of any emergency landings there. The team included a radsafe monitor, four crash-firefighters, one radio direction-finder operator, one radio repairman, and one medical technician.

The results of the early aerial radiation survey, ground surveys by the initial reentry parties, an H+2 damage survey by Commander TU 132.1.1, and lagoon water sampling at the anchorages off Parry and Enewetak allowed reentry to begin at 0900 on 2 November.

Sampler aircraft supplied exposure rate information to the Radsafe Center on Rendova during the period from H-hour to H+6. From H+6 to H+17 the equipment used by Hq USAF personnel in their normal flights served both Hq USAF and radsafe purposes. From H+12 until H+48 the weather reconnaissance flights provided data about the movement of the cloud (Reference C.0.1).

All radsafe data were assimilated by the Radsafe Center before being forwarded to the Command Center aboard Estes. Cloud-tracking reports and radiological situation maps of all islands of Enewetak Atoll and neighboring atolls were maintained. These data formed the basis for periodic briefings and situation reports prepared for the commander of the joint task force and his task group commanders (Reference C.0.1, p. 229). The data also formed the basis for planning later recovery operations and disposition of working parties.

Sample Recovery Techniques

Upon completion of sampling operations, the samplers returned to the airfield at Kwajalein, where the particulate and gaseous snap-bag samples were immediately recovered from the aircraft. Separate crews were used for the two operations.

PARTICLE SAMPLE REMOVAL. Detailed techniques for recovering filter papers from the wingtip tanks were published by LASL and forwarded to AFSWC in 1956 (Reference A.4, pp. 220-225). This publication documented techniques employed during IVY and, later, for CASTLE. Figure 16 illustrates the setup for sample recovery.

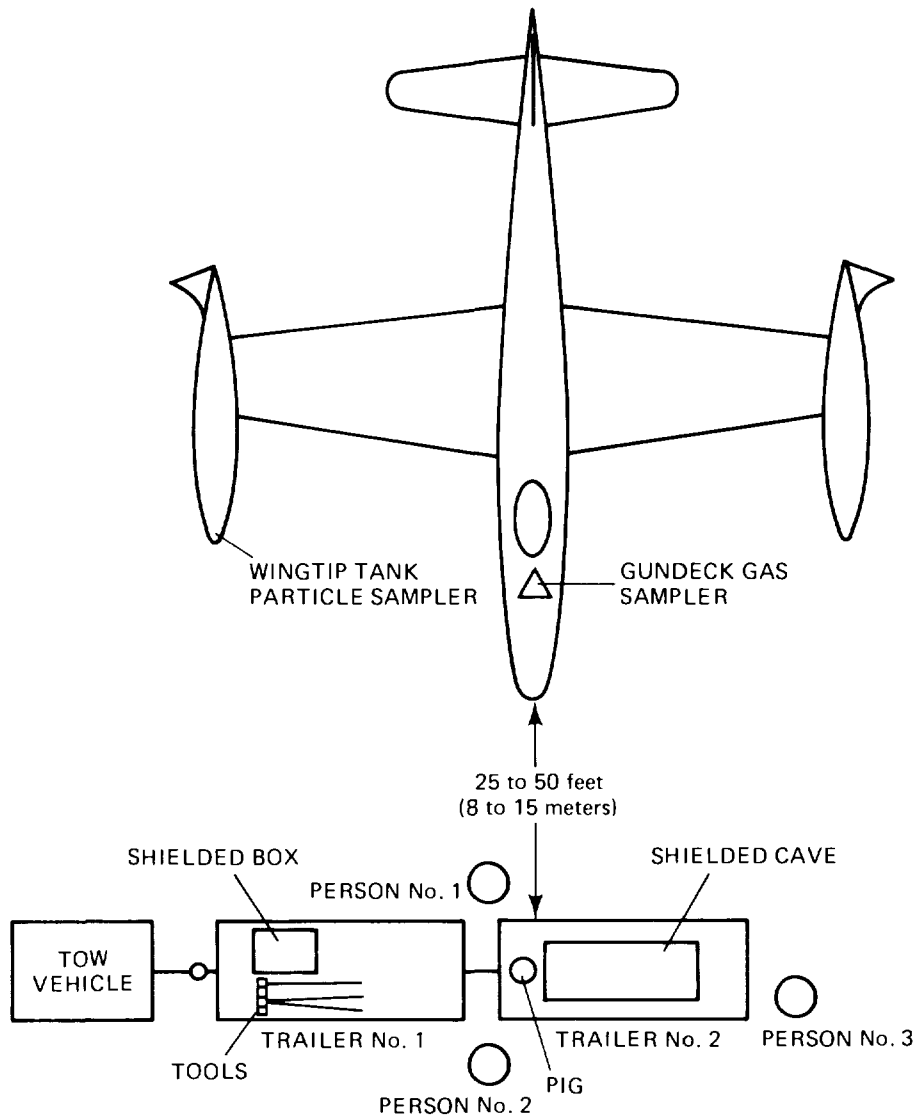

Figure 16. Sample recovery schematic illustration.

Three people were directly engaged in particle sample removal. A minimum distance of 25 feet (8 meters) was used as a criterion for separation of sample removal equipment from the "hot" sample pod, as well as for personnel while not removing samples. A fourth person served as an overall supervisor to ensure compliance with sample removal procedures. Person No. 1 advanced to the pod with long-handled tongs, cut the filter retaining-wire, then returned to his initial position, still holding the tongs. Person No. 2 advanced with a 9-foot (3-meter) removal pole. He hooked the filter paper on which the sample was deposited with the end of the pole and deposited the paper in the shielded

"cave," or enclosure. Person No. 1 stood by to help No. 2 by using the long-handled tongs if the sample should fall to the ground. After the sample was deposited in the cave, person No. 1 returned the tongs to the tool trailer and secured a hook tool. He then joined No. 2 and opened the sample holder for No. 3 to insert a rolling tool over the filter paper. As No. 3 rolled the filter paper, No. 1 and No. 2 stood "well clear of the cave, aircraft, and other radiation sources." Person No. 3 put the rolled paper in a "pig," a shielded container for sample transport, and returned his tool. Person No. 1 measured the radiation inside the pig using a long-handled tool and this information was recorded. Person No. 1 returned the tool, then both No. 1 and No. 2 lifted the pig, whose lid closed automatically, from the cave with a carrying pole, carried it to a third trailer 25 feet (8 meters) away, and deposited it in a shielded box. This operation was repeated on the second sample pod, then the next aircraft, until all filters were removed.

GAS SAMPLE REMOVAL. Gas samples were removed by two five-man teams. Each team consisted of a senior civilian technician, two enlisted armament men, tug and trailer driver, and one officer who functioned as a recorder. Each team member wore radsafe clothing and, in addition, the civilian technicians and the armament men wore lead gloves.

Degassing equipment included a cart with a vacuum pump for each team, metal cylinders for bottling the gas samples, and hoses with nozzles that were inserted into the aircraft gas probe to form an airtight fit.

The gas samples were transferred from the aircraft snap-bag to the sample bottles by evacuating air from the bottles with the vacuum pump, then using an external power unit to open a solenoid valve between the probe and the snap-bag mounted in the nose of the aircraft. The vacuum in the sample bottles then drew the gas sample from the snap bag. Separate sample bottles and hoses and nozzles were used on each aircraft.

The degassing procedure required the armament men to change the sample bottles, hoses, and probes for each sample taken. They also opened the gun-deck lid on the aircraft and secured it after the sample was taken and the snap-bag was removed. The civilian technician and the recorder positioned the

degassing cart for each sample. The civilian technician inserted the hose nozzle and operated the vacuum pump; he also removed the snap-bag from the aircraft and sealed its inlet with tape. The armament men loaded the filled sample bottles and used hoses and nozzles onto the trailer. Nozzles and hose ends were taped closed by the tug driver, who also marked the snap-bag and hoses and nozzles with the same number as their corresponding sample bottle (Reference C.1.3.617, pp. 161-162).

Decontamination

When aircraft decontamination was necessary, land-based aircraft on Kwajalein were towed to the decontamination area where working parties decontaminated them as quickly as possible. The TG 132.4 Radsafe Section was originally assigned an aircraft decontamination area at Kwajalein that proved to be unsuitable, since it was located on the parking ramp and in such proximity to the engine run-up area that the possibility of spreading contamination over wide areas was introduced. In addition, the pavement was asphalt, which easily collected contamination. It also had insufficient slope to permit drainage of contaminated washing solutions. A 120- x 200-foot (37- x 61-meter) decontamination ramp of trowel-finished concrete was constructed on an isolated area at the downwind end of the island. The ramp wash area was sloped for easy flushing and positive drainage into the open sea. This ramp location was such that if contamination persisted it could be roped off without hindering operations in more congested areas (Reference C.4.4, Mar-Apr Inst, pp. 57-58).

At the completion of a decontamination operation, the personnel involved were monitored on the spot, first with clothing on, then again without clothing. If contaminated, they were sent to a personnel decontamination center where they were advised of their degree of contamination with special attention directed to hands, hair, and soles of shoes. After showering, personnel were again monitored and, if skin counts were less than twice background count, released. Washing was continued as necessary to assure the required degree of decontamination.

Two buildings on Kwajalein were used as a personnel decontamination center, one building (formerly a latrine), 12 by 24 feet (4 x 7 meters), and one shower

house, 20 by 40 feet (6 x 12 meters). The smaller building was used as an office and the shower room was converted into the actual space where personnel decontamination occurred. Additional facilities were constructed in the center for the storage and issue of clothing and for the repair and calibration of radiac instruments.

Limited decontamination of carrier-based aircraft was done aboard Rendova; however, it was planned that major decontamination of TG 132.3 aircraft (except for helicopters which would be decontaminated at Enewetak) would be done, if such became necessary, using TG 132.4 facilities. Aircraft decontamination operations aboard Rendova required special precautions because of the crowded conditions aboard. The area used was isolated from personnel living quarters and from ventilator intakes while a clear drainage to the sea was provided to prevent spread of contamination to other parts of the vessel. Provision was made to package (or throw overboard) contaminated items in the decontamination area, and any material leaving that area was carefully monitored.

TG 132.1 controlled decontamination on Enewetak (Reference C.1.7.1, p. 32). On return from a mission the vehicle, boat, or aircraft used was met at the checkpoint by the checkpoint officer, the personnel were monitored, and appropriate instructions were issued. Personnel were guided by signs and verbal instructions to the personnel decontamination center in the south end of the radSAFE building on Parry Island. This center was conveniently located near each of the checkpoints to minimize "tracking" of contaminants. Upon entering the center, personnel disrobed, discarded protective clothing and items of equipment in appropriate, marked containers, showered, and then passed into the drying room, where they were again monitored. If "clean," they passed into the "clean" change room, retrieved their personal clothing, dressed, and returned to their organizations. If found still contaminated, they were returned to the shower. In several cases, localized "hot" spots were found on body extremities (most often the hands); these were decontaminated by applying a hand brush, more soap, and rinsing.

Various chemical solutions and agents were available to aid in the equipment decontamination, but their use was usually not necessary. Generally,

contamination was controlled with high-pressure water jets, commercial detergents, vacuuming, and sweeping using the following procedures:

1. Equipment decontamination. A control checkpoint was established at the boat landing just north of the personnel pier on Parry Island. Departing land vehicles had their interior surfaces lined with paper to minimize contamination by their occupants while returning from contaminated areas. All landing craft with vehicular or other mobile equipment were instructed to land at the designated boat landing, where the control officer of the checkpoint monitored the equipment. If "clean," the equipment was released for movement to its destination; if contaminated, it was moved to the decontamination area just above the landing area, where decontamination procedures were applied. Steps consisted of removing paper linings (when applicable), sweeping, and hosing with high-pressure water jets from the decontamination apparatus. If the procedures were unsuccessful, the equipment was moved to the contaminated storage area in the field just north of the Radsafe Building on Parry Island. Decontamination work was done by a decontamination team of three enlisted men. This team worked at all decontamination areas on call from the appropriate control-checkpoint officer.
2. Small boats. In general, the same decontamination methods were used for small boats as for land vehicles, except that paper liners were not used.
3. Aircraft. A control checkpoint was established at the airstrip on Parry Island. Aircraft departing on missions into highly radioactive areas had their interiors lined with paper. On return from a mission the paper liners were removed as required, and the interiors were cleaned by brushes and industrial-type vacuum cleaners.
4. Personnel. Complete suits of protective clothing were donned by personnel before departure for radioactive areas. Outfits consisted of the following:

Fatigue hat

Pair of coveralls

Pair of radsafe socks

Pair of radsafe shoes

Pair of bootees for each aircraft, vehicle, or small boat embarkation and debarkation

Appropriate gloves (cotton, surgical, work, etc.)

Respirator (to be worn if needed).

The use of radsafe socks and shoes was insisted upon so that, if contamination occurred, no personal clothing

would have to be confiscated by the Decontamination Group. For personal items this necessarily would have involved troublesome administrative procedures.

Shipments from the Pacific Proving Ground

All shipments of surplus equipment and other materiel returning from the PPG to the United States were potentially contaminated in excess of background radiation. For this reason, the sale to the general public of shipping containers from the PPG was restricted.

Interstate Commerce Commission (ICC) regulations required that all shipments of radioactive isotopes in commercial carriers be packaged to preclude emission of significant alpha or beta radiation from the exterior of the package, and the gamma radiation emission at any surface of the package was required to be less than the equivalent of 0.010 R of radium gamma radiation (filtered through 0.5 inch [1.27 cm] of lead) for 24 hours. This meant, in many cases, a holding period in excess of 4 months from release from contaminated storage to acceptable shipment of items by common carrier in the United States. Because agencies often could not wait out this decay period, courier service was utilized. Courier service was not subject to ICC regulations unless a common carrier was used. These shipments had to comply with joint task force regulations on transport of radioactive materials.

Release of Navy Ships

Postshot release of Navy ships was conducted either under a final radsafe clearance or an operational clearance as defined in NavMed P-1325, Radiological Safety Regulations (Reference A.7). Final clearance was defined as the vessels having been monitored and found to have at no point a reading exceeding 0.015 R/24-hour period (beta plus gamma) and no detectable alpha-emitting isotopes. At the conclusion of Operation IVY, if a vessel had some area or material that had not yielded to decontamination, the vessel could be released to its type commander under an operational clearance. However, for this type of release, an integrated exposure of beta plus gamma of below 3 R, and no detectable alpha radiation, applied in general. Resurvey of the contaminated area was to be conducted within the following 3 months and referred to the type commander for final clearance.

CHAPTER 3

DOD EXPERIMENTAL PROGRAM

The experimental program for IVY focused primarily on the MIKE experiment, the first fusion device, and secondarily on KING, a high-yield, all-fission weapon. The experimental program was heavily oriented toward weapon development experiments and less on effects experiments. Effects experiments for the four services had been solicited by the Armed Forces Special Weapons Project (AFSWP), and AFSWP negotiated with Los Alamos Scientific Laboratory (LASL) to fit these effects experiments into the weapon development program without interference or duplication.

Task Group (TG) 132.1, the scientific task group, was divided into task units to conduct the experimental program. Task unit missions within the task force are summarized in Chapter 1. Of primary interest in this chapter are Task Unit (TU) 132.1.1 (Scientific), TU 132.1.7 (Radiological Safety), and TU 132.1.9 (Documentary Photography), the task units with heaviest Department of Defense (DOD) participation. Sources of personnel for the task group staff and the task units are given in Table 16. The IVY experimental program was divided into 11 programs, which were further divided into projects. Programs were as follows:

1. Radiochemistry
2. Progress of The Nuclear Reaction
3. Scientific Photography
4. Neutron Measurement
5. Gamma-Ray Measurements
6. Blast Measurements
7. Long-Range Detection
8. Thermal Radiation Measurements
9. Electromagnetic Phenomena
10. Timing and Firing
11. Preliminary Geophysical and Marine Survey of Test Area.

Table 16. Sources of Task Group 132.1 personnel, IVY.

Organization	Civilian Personnel														Military Personnel				Grand Total		
	AEC Organizations and Contractors				Service Labs and Contractors				Other	Civ Total	Army	Air Force	Navy	Mil Total							
	AEC	LASL	SC	ACF	CAMCO	EG&G	HLJ	ESL							ONR	MRL	NOL	NEL		CRC	WADC
CTG 132.1	2	21	1												5	29	4	1	1	6	35
J-1		3														3	15	12	5	32	35
J-2	2	4														6	2	3		5	11
J-3		2														2	14	4	5	23	25
J-4		4														4	8	7	3	18	22
TU 132.1.1		10														10	1	5	3	9	19
Program 1		11														11		11		11	22
Project 1.1																					N/A
Project 1.2		1														1					1
Project 1.5																					N/A
Program 2		1														1					1
Projects 2.1, 2.4										67						67	4	6	19	29	96
Project 2.2																					N/A
Project 2.3																					N/A
Project 2.5			3															4		4	7
Project 2.6																					
Program 3																					
Project 3.1, 3.2											8								3	3	11
Project 3.3											33								2	2	35
Project 3.4			7															1		1	8
Projects 3.5, 3.6																				1	1
Project 3.7																					N/A
Project 3.8																					N/A
Program 4																					N/A
Project 4.1			6																		6
Project 4.2																					N/A
Project 4.3																					N/A
Project 4.4																					N/A
Program 5																					N/A
Project 5.1			4																		4
Projects 5.2, 5.3			2																	2	4
Project 5.4a			2													9				11	11
Project 5.4b										1						7				8	18
																4				6	12

(continued)

TASK UNIT 132.1.1 ACTIVITIES

This chapter describes the experimental activities of TG 132.1 and relates them to potential and actual radiation exposures experienced during the conduct of these activities. Activities that exposed personnel of the experimental group to radiation were placement of instruments in areas made radioactive by earlier testing and recovery of data and instruments after the shot.

The contribution to the actual exposures of the secondary fallout that occurred several days after MIKE is not considered in this chapter, but is discussed in the chapters that follow. Exposures to this secondary fallout were experienced by all personnel at the test site, not just the experimentalists. These exposures were to very low levels (a few thousandths of roentgens per hour, peak) and days would have been required to accrue a measurable dose. The film badges, issued primarily to the experimentalists, recorded exposures accrued in a few hours. Therefore, exposures recorded in the Consolidated List (Reference C.1.7.2) can be attributed primarily to instrument placement and recovery activities.

The first four programs consisted of experiments on projects whose purposes were almost exclusively weapon development. In Programs 5 through 9 and 11 the projects were more effects-oriented. Program 10 was more in the nature of scientific support than experimentation.

Pre-IVY radiological conditions are discussed in Chapter 1, which says, in summary, that instrument placement on Enjebi, Eleleron, and Runit would have required personnel to be in areas that could have exposed them to radiation. Instrument placement activities for the KING shot following MIKE similarly would have required participating personnel to be in radioactive areas. Appendix C presents detailed air and ground readings of radiation intensity for many of the islands of the atoll for the period following MIKE to the end of the series. Table 17 lists most of the islands of the atoll and shows their relationships to the MIKE detonation point, their radiation environment, and the recovery missions planned for each. Table 18 presents the schedule for each mission listed in Table 17. The recovery schedule in Table 18 is clearly pre-shot, although it was extracted from an after-action report (Reference

Table 17. Islands of Enewetak Atoll, their distances from surface zero, their radiation environment, and planned IVY, MIKE recovery missions.

	Distance to Burst Point in nmi (km)	Radiation Environment ^a (R/hr)		Project Instrumentation Sites	Planned MIKE Recovery Missions ^b
		H+1	H+4		
Bokoluo	3.0 (5.6)	>2,300	>435	1.3, 3.3, 3.4, 5.1, 5.3, 5.4a, 5.4b, 8.1, 8.2, 8.3	7, 10, 11, 12, 14, 16, 19, 20, 28
Bokombako	2.2 (4.1)	>2,500	>470	5.1, 5.2, 5.4b	9, 12, 19
Kirunu	1.5 (2.8)	>2,500	>470	5.1, 5.2, 5.3, 5.4b	9, 12, 19
Louj	1.0 (1.9)	>2,500	>470	4.1, 4.2, 5.1, 5.2	5, 9, 19, 20
Bokinwotme	0.7 (1.3)	>4,500	>850	1.1b, 4.1, 4.2, 4.4, 5.1, 5.2	5, 6, 9, 19
Eluklab ^c				4.1, 4.2, 5.1	19
Dridrilbwij	0.5 (0.9)	>8,500	>1,600	5.1, 6.1, 6.3, 6.5, 6.7b, TU 132.1.7	19, 21, 27, 28
Bokaidrikdrik	0.7 (1.3)	>1,700	>320	5.1	19
Boken	1.2 (2.2)	>2,600	>500	2.1a, 2.2, 2.3, 2.4, 2.6, 5.1, 5.3, 5.4b, 6.1, 6.3, 6.5, 6.7a, 6.7b, 8.1, 8.2, 8.3, TU 132.1.9	8, 10, 12, 19, 20, 21, 24, 27, 28
Enjebi	2.7 (5.0)	>1,000	>200	3.1, 5.1, 5.3, 5.4a, 5.4b, 6.1, 6.2, 6.3, 6.5, 6.7b, 6.9, 8.1, 8.2, 8.3	10, 11, 12, 13, 14, 15, 17, 19, 20, 21, 22, 23, 25
Mijikadrek	3.2 (5.9)	>1,000	>200	5.4b, 6.1, 6.3, 6.5, 6.7b	12, 21
Kidrinen	3.7 (6.9)	>1,000	>200	5.4b, 6.3, 6.9, 8.1, 8.2, 8.3	10, 12, 21, 23, 25
Bokenlab	5.0 (9.3)	>920	>175	5.4b, 6.3, 6.9, 8.1, 8.2, 8.3	10, 21, 23, 25
Elle	5.5 (10.2)	>685	>130	5.4a, 5.4b	11, 12
Aej	6.0 (11.1)	>685	>130	5.4b, 8.1, 8.2, 8.3	10, 12
Lujor	6.5 (12.0)	>685	>130	5.4b	12
Eleleron	7.1 (13.1)	>685	>130	5.4b	12
Aomon	7.7 (14.3)	>685	>130	5.4b, 6.1, 6.3, 6.5, 6.7b, 6.9	12, 21, 23, 25
Bijire	8.0 (14.8)	475	90	5.3, 6.2, 8.1, 8.2, 8.3	10, 12, 20, 21, 22
Lojwa	8.3 (15.4)	290	55	5.4b, 6.2	12, 22
Alembel	8.7 (16.1)	---	---	5.4b	12
Billae	9.0 (16.7)	185	35	5.4a, 5.4b	11, 12
Runit	11.7 (21.7)	0		5.3, 5.4a, 5.4b, 6.1, 6.2, 6.3, 6.5, 6.7b	12, 20, 21, 22
Ananij	14.2 (26.3)			5.3, 5.4a, 5.4b	11, 12, 20
Japtan	15.6 (28.9)	0		5.4b	12
Parry	16.1 (29.8)	0		3.1, 3.2, 3.5, 5.3, 5.4a, 5.4b, 6.1, 6.2, 6.3, 6.7b, 8.1, 8.2, 8.3, 9.3	3, 4, 10, 11, 12, 18, 20, 21, 22, 26
Enewetak	17.8 (33.0)			2.1, 5.3, 5.4a, 5.4b	11
Ikuren	16.3 (30.2)	0		5.4b	12
Biken	13.7 (25.4)	13.2		5.3, 5.4b, 6.1, 6.3, 6.5, 6.7b	12, 20, 21

Notes:

^aSee Appendix C for actual readings.

^bSee Table 18 for mission details; missions 1 and 2 included all islands.

^cDetonation point, destroyed.

Source: Reference C.1.7.1.

Table 18. Planned schedule for IVY, MIKE recovery missions.

Mission	Project	No. of Persons	Means of Transportation	Islands Visited and Remarks
High Priority				
1	Aerial survey	3	Helicopter	All islands
2	Commander Task Group 132.1	3	Helicopter	Damage survey; leave <u>USS Rendova</u> (CVE-114) after completion of aerial survey
3	Utilities crew	5	Helicopter	Parry; leave <u>Rendova</u> H+20 minutes
4	3.1, 2.1, 8.2, 9.1, 5.3	7	2 helicopters	Parry; leave <u>Rendova</u> H+20 minutes; 3 persons for 3.1; 2 for 8.2; 1 each for 2.1 and 9.1; none in 5.3; phototower, Bldgs 2212, 232
5	4.1, 4.2	8	LCM, LCU, 2 DUKWs	Louj and Bokinwotme; 4 project personnel; 4 Holmes & Narver, plus boat crews; 2 monitors
6	4.4	4	Helicopter	Bokinwotme
7	3.3, 3.4	4	Helicopter	Bokoluo (Station 300)
8	2.1 to 2.4	8	2 helicopters	Boken (Station 200); possibly could use 1 helicopter; 2 trips
9	5.2	3	Helicopter	Kirunu (high priority); Bokombako, Louj, and Bokinwotme (low priority)
10	8.1, 8.2, 8.3	6	Helicopter and DUKW with A-frame	Enjebi and Bijire (high priority); Bokoluo, Boken, Kidrinen, Bokenlab, Aej, Parry (lower priority); total of 400 pounds (180 kg) to be picked up at Enjebi and Bijire; 5 recovery personnel, 1 Holmes & Narver, DUKW operator
11	5.4a	6	2 LCMs, helicopters	Seven stations from Enjebi clockwise to Enewetak plus Bokoluo; 20 stations in lagoon; 6 recovery personnel, plus boat crews; 3 monitors
12	5.4b	4	Helicopter	Twenty-six stations from Bokoluo clockwise to Kidrinen, including photo tower on Unibor; 2 persons collect samples; 2 remain on FF to prepare samples; 50 pounds (23 kg) picked up at each station.
13	6.2	1	Helicopter	Monitors check to see that anti-aircraft guns on Enjebi have fired (open breech)
14	Program 1	3	Helicopter	If air-sampling program fails, must get hot samples of water immediately; also Bokoluo (Station 300)
15	3.1	2	Helicopter	Enjebi; if yield low, immediate recovery of film necessary
Low Priority				
16	1.3	2	Helicopter	Bokoluo (Station 300)
17	3.1	2	Helicopter	Enjebi
18	3.2, 3.5	2	Helicopter	Parry
19	5.1	3	Helicopter	Ten islands between Bokoluo and Enjebi
20	5.3	2	Helicopter	Six islands from Boken through Parry including Runit, plus Kirunu, Bokoluo and Biken
21	6.1, 6.3, 6.5, 6.7b	4	Helicopter	Nine islands from Dridrilbwij, Boken, to Parry including Runit
22	6.2	2	Helicopter	Five islands between Enjebi and Parry
23	6.3	2	LCM, truck	Enjebi, Kidrinen, Bokenlab, and Aomon
24	6.7a	3	LCM, truck	Boken; required only if cable beached
25	6.9	2	LCM, 3/4-ton truck	Enjebi, Kidrinen, Bokenlab, and Aomon
26	9.3	2	Helicopter	Parry
27	TU 132.1.9	3	LCM	Dridrilbwij and Boken
28	Removal of cameras	5	Helicopter	Bokoluo (Station 300), Boken (Station 200), and Dridrilbwij (Station 250) (note: film removed from these cameras in earlier recovery)

Source: Reference C.1.7.1.

C.1.7.1). Where possible, the actual conduct of those recovery missions is discussed in each project description.

Helicopter Support

Helicopters were the most frequently used transportation for instrument recovery. Army, Navy, Marine Corps, and Air Force helicopters were available for this work. The Marine Corps and Navy helicopters were based aboard USS Rendova and organized into one unit under the control of CTG 132.3. Operation Plan 2-52 called for TG 132.3 (Navy) helicopters to provide transportation for damage survey and for recovery of scientific samples and film (Reference B.3.2, Annex G, Change No. 1, p. G-1). Air Force H-19 helicopters were used for radiation survey (Reference C.1.7.1, p. 26). The two survey crews, however, were from TU 132.1.7 and the pilots were "from a pool of about 20 Air Force, Navy, and Marine pilots" (Reference C.1.3.617, pp. 111). Army H-13 helicopters carried only one passenger, so their use probably was limited to observation missions (Reference C.1.1, p. 23; Reference C.0.1, p. 119). Separate exposure data for Air Force, Navy, and Marine Corps helicopter pilots can be identified from the 5x8 card microfilm file (Reference C.1.7.3). Navy and Marine Corps helicopter crews, which can be identified as a group, had the highest exposure of personnel in the carrier unit, but none exceeded 2.815 R. Collective exposures for the helicopter pilots are shown in Table 19. This table also presents the exposures of all TG 132.1 personnel whose activities can be related to the projects and programs that made up the experimental program.

In constructing Table 19, after-action project reports (Weapon Test, or WT, reports) and 5x8 cards of Personnel Radiation Exposure Record -- Microfilm (Reference C.1.7.3) were examined for clues as to which individuals identified in the Consolidated List (Reference C.1.7.2) were associated with each project activity. Project reports, however, often do not acknowledge all the members of the project. Moreover, only a few of the 5x8 cards show personnel activities other than organization. Furthermore, it seems probable that not all of those personnel acknowledged in the reports as aiding in projects went to the Pacific Proving Ground (PPG). It also appears that not even all scientific personnel (TG 132.1) at the PPG were badged, since some names mentioned in the project reports as contributors to the conduct of the experiments do not appear

Table 19. IVY personnel exposures, Task Group 132.1.1.

Element	No. of Persons Badged	Exposure Ranges (roentgens)												Over 15	Over 15 3.9a	High (R)	
		0	0.001-0.5	0.5-1	1-1.5	1.5-2	2-2.5	2.5-3	3-4	4-5	5-10	10-15					
Helicopter Pilots	8	2	1	2	1	2											2.2
Program 1	1	1															0.1
Project 1.1	1	1															0.2
Project 1.2	1			1													1.8
Project 1.3	1	1															0.4
Sampler Pilots	27 ^b	13	5	4	4	1						2					3.5
SA-16 Crew	6												5	1	6		17.8
Program 2																	
Projects 2.1a, 2.2, 2.3, 2.4, 2.6	24	1	6	7	9	1											1.7
Project 2.1b	4	3	1														0.6
Project 2.5	4	4															0.3
Program 3	1	1															0.6
Project 3.1	4		2	2													1.2
Project 3.3	4		2	2	1	1					1						2.8
Project 3.4	3		1	1	1	1					1						2.7
Project 3.7	1	1															0.3
C-54 Crew	12												1	11	12		11.6
Program 4																	
Projects 4.1, 4.2	6		1	3	2												1.9
Program 5	1																2.8
Project 5.1	3										1	1	1				3.1
Project 5.2	8	1	1	1	1	1	2										2.8
Project 5.3	3		1	1	1	1											1.5
Project 5.4a	9	4	2	1	1	2											2.4
Project 5.4b	8				2	1	4	1									3.3

(continued)

Table 19. IVY personnel exposures, Task Group 132.1 (continued).

Element	No. of Persons Badged	Exposure Ranges (roentgens)													Over 15	Over 15 3.9 ^a	High (R)
		0	0.001-0.5	0.5-1	1-1.5	1.5-2	2-2.5	2.5-3	3-4	4-5	5-10	10-15					
Program 6	2		1	1													1.1
Projects 6.1, 6.3, 6.5, 6.7b	16	2	4	3	5	2											2.5
Project 6.2	1	1															0.4
Project 6.3 ^b	2		1	1													1.2
Project 6.4a	1	1															0.3
Project 6.4b	1	1															0.1
Project 6.9	3	1	1		1												2.1
Project 6.10	25 ^c	17	7														0.2
Project 6.11	16	2	14														0.3
Project 6.13																	
Program 7	1	1															
Program 8																	
Projects 8.1-8.4	9		1	2	1	1	2	2							1		4
Project 8.2 ^d	1																4.1
Project 8.3 ^d	2	2												1			0.2
Program 9																	
Project 9.1	1	1															
Project 9.3	2	2															
Program 11	1																
Project 11.5	6	1	3	1	1												1.7
Task Unit 7	46	1	10	12	0	7	6										2.9
Task Unit 9	25	1	16	1	1	1									5	5	11.6

Notes:

- ^aMaximum permissible exposure.
 - ^bTwo badge readings missing.
 - ^cOne badge damaged.
 - ^dStaff in addition to that shared with Projects 6.1, 6.5, and 6.7b.
- Source: Reference C.1.7.2.

on the Consolidated List. These may have been men who worked in clear areas at the PPG such as the base islands or the MIKE complex, were evacuated before MIKE, and did not return to the PPG after MIKE.

Relating the information in Table 16 to the information presented in Table 19 is difficult. The value of Table 16 comes from its presentation of the probably correct overview of TG 132.1 and its somewhat more approximate view of how the personnel were distributed by programs. Table 19 presents the recorded exposures of the badged members of TG 132.1 during the experimental activities.

Boat Support

Seaborne transportation to the northern islands was provided by the TG 132.1 boat pool, augmented by the TG 132.3 boat pool of TG 132.3 (Reference B.0.2, Annex R, p. R-1). TG 132.3 boats were part of its harbor control task element. Records are not available on contamination of TG 132.1 ships or exposures of their crews. However, the fleet tug, USS Lipan, and the five LCUs attached to the harbor control task element "were contaminated above tolerance levels while they were operating in the contaminated waters or on the contaminated beaches in the northern sections of Enewetak lagoon" (Reference C.3.2, pp. 5-7). Exposures for the crew of Lipan and the five LCUs are presented in Table 28, Chapter 6.

KING data-recovery activities are summarized in Tables 20 and 21. Table 20 lists contamination levels on the islands following KING and the recovery missions planned. Table 21 presents the details of the missions.

PROGRAM 1 -- RADIOCHEMISTRY

The yield of a nuclear explosion can be measured by radiochemical analysis of the device debris. Aircraft flying through the shot cloud were used to collect needed samples from both MIKE and KING, but plans had been made to collect MIKE samples from Station 300 near Boken Island as well as from the lagoon if airborne sampling failed (Reference C.1.7.1, p. 98). In earlier Pacific tests this sampling had been done by unmanned radio-controlled airplanes.

Table 20. IVY, KING radiation levels and planned reentry missions.

Location	Distance to Surface Zero in nmi (km)	Ground-Level Reading on D-day (R/hr)	KING Planned Missions ^a
Bokoluo	11.2 (20.7)	1.4 ^b	15, 22
Bokombako	11.0 (20.4)	1.2	15
Kirunu	10.5 (19.4)	0.7 ^c	15
Boken	9.1 (16.9)	1.2 ^c	15
Enjebi	7.9 (14.6)	1.1	15, 22
Mijikadrek	7.1 (13.1)	0.6 ^c	15
Kidrinen	6.9 (12.8)	0.4 ^c	15
Bokenlab	5.8 (10.7)	0.4 ^b	15
Elle	5.3 (9.8)	0.4	15
Aej	5.0 (9.3)	0.3 ^c	15
Lujor	4.6 (8.5)	0.3 ^d	15
Eleleron	4.0 (7.4)	0.2 ^c	15
Aomon	3.8 (7.0)	0.2 ^c	15
Bijire	3.3 (6.1)	0.2	5, 13, 15, 22
Lojwa	3.1 (5.7)	0.2 ^b	4, 15
Alembel	2.6 (4.8)	0.1 ^b	15
Billae	2.1 (3.9)	0.1 ^b	15
Runit ^e	0.5 (0.9)	0.1 ^b	1, 2, 3, 4, 6, 10, 12, 15, 22
Ananij		---	5, 15, 22
Japtan	6.9 (12.8)	---	15
Parry	7.9 (14.6)	---	4, 5, 15, 22
Enewetak	10.8 (20.0)	---	15, 22
Biken	14.1 (26.1)	---	15
Drekatimon			7, 15
Unibor	5.4 (10.0)		7, 15

Notes:

^aSee Table 21 for details.

^bReading on 17 November.

^cReading on 21 November.

^dReading on 18 November.

^eTarget island.

Table 21. Details of planned IVY, KING recovery missions.

Mission	Time	Project	No. of Persons ^a	Means of Transportation	Destinations and Remarks
1	H+30 min	Aerial survey	2	Helicopter (1)	All islands; inspect rocket launchers of Project 6.13 on Runit, Station 6140, for misfire
2	H+1	6.13	2	Helicopter (1)	In case of rocket misfire, dispose of dud
3	H+1	2.1b	3	Helicopter (1)	Runit
4	H+1	3.1, 3.2, 3.5, 3.6, 3.8, 6.2, 6.13	4	Helicopter (1)	Parry, Station 301; Runit, Station 307; Lojwa; Stations 305 and 306, and 303.09 to 303.16
5	H+1	8.2, 8.3	4	Helicopter (1)	Ananij, Station 804; Bijire, Stations 802 and 803; Parry, Station 301
6	H+1	6.1, 6.3	3	Helicopter (1)	Runit, Station 605
7	H+1	Programs 3 and 8	4	LCM (1)	Drekatimon and Unibor
8	H+4	Damage survey	2	Helicopter (1)	
D+1					
9	0730	Aerial survey	2	Helicopter (1)	All islands
10	0730	Ground survey	2	Helicopter (1)	Runit; other islands as required.
11	0800	Water survey	2	Helicopter (1)	Lagoon
12	0900	4.1, 4.2, 4.4, 5.1, 5.2, 8.1		LCU (1), DUKWs (2), 1/4-ton truck (1), 3/4-ton trucks (2), 3/4-ton truck with A-frame (1)	Runit, Stations 412.01-4.2.24, 441, 511.01-511.25, 521.04-521.06, 810.09-810.11

(continued)

Table 21. Details of planned IVY, KING recovery missions (continued).

Mission	Time	Project	No. of Personsa	Means of Transportation	Destinations and Remarks
D+1 (continued)					
13	0900	6.3	2	LCM, 3/4-ton truck	Bijire, Station 630.04
14	0900	6.2	3	LCM	Lagoon to recover rafts
15	0900	5.4b	4	Helicopter (1)	Twenty-six stations from Bokoluo clockwise to Biken plus Drekatimon and Unibor
16	1600	Water survey	2	Helicopter (1)	Lagoon
D+2					
17	0730	Aerial survey	2	Helicopter (1)	All islands
18	0730	Ground survey	2	Helicopter (1)	As required
19	0800	Water survey	2	Helicopter (1)	Lagoon
20	0800	5.4b			Continues from previous day
21	1600	Water survey	2	Helicopter (1)	Lagoon
AFTER D+2					
22	0800	5.3	2	Helicopter (1)	Seven stations from Enjebi to Biken, plus Bokoluo

Notes:

^aExclusive of crew.

^bApproximate.

TU 132.1.1 assigned 11 LASL and 11 Air Force personnel to work on the program (Reference C.1.3.636, p. 17). Only the program director, a LASL civilian with a recorded exposure of 0.115 R, however, can be identified on the Consolidated List (Reference C.1.7.2).

Project 1.1 -- Yield Measurements

Agency: Los Alamos Scientific Laboratory

Operations: TG 132.4 aircraft collected samples from both the MIKE and KING clouds. On Kwajalein these were removed from the sampler aircraft and flown to the United States. Coral samples from Bokinwotme Island were also gathered for analysis of heavy nuclides produced by MIKE. The potential for project sampling crews, ground crews, and those preparing samples for shipment being exposed to radiation during project activities is discussed under Project 1.3.

Staffing: One of the two men who gathered coral samples for this project had an accumulated exposure for the series of 0.2 R. The other is not on the Consolidated List. The project leader was also the program director.

Project Report: Reference C.1.3.630.

Project 1.2 -- Internal Nuclear Measurements

Agency: Los Alamos Scientific Laboratory with USAF support
(see Project 1.3)

Operations: TG 132.4 aircraft collected MIKE cloud samples. On Kwajalein these were removed from the sampler aircraft and flown to the United States. The possibilities of radiation exposure during project activities is discussed under Project 1.3.

Staffing: One man had a series exposure of 1.791 R.

Project Report: No Weapon Test report was issued.

Project 1.3 -- Cloud Sampling

Agency: Los Alamos Scientific Laboratory (LASL) and the following task elements (TE) of TG 132.4:

Sampler Element (TE 132.4.2.1)
Control Element (TE 132.4.2.3)
Tanker/Instrumentation Element (TE 132.4.2.4)
Search and Rescue Element (TE 132.4.3.4).

Operations: F-84G samplers penetrated the MIKE and KING detonation clouds to gather gaseous and particulate debris for Projects 1.1, 1.2, 5.4b, and 7.3. They were directed by B-29 navigation control (NAVAID) aircraft and a B-36 mission control aircraft and supported by KB-29 tanker aircraft and SA-16 search and rescue (SAR) aircraft. After the samplers returned to Kwajalein, samples were unloaded, packed, and flown to the United States.

Sampler aircraft pilots were exposed to radiation while in the shot cloud and to radiation from cloud particles sticking to the outer surfaces of their aircraft after leaving the cloud. Following the MIKE shot, in an effort to reach a downed sampler aircraft, an SA-16 flew through highly radioactive airspace, resulting in exposures to the crew (Reference C.4.4, MIKE Inst, p. 27). MIKE also contaminated other aircraft involved in Project 1.3, including five KB-29 tanker planes, two B-29 NAVAIID aircraft, and the B-36 mission control aircraft. Other than the sampler aircraft, KING appears to have contaminated only the B-36 mission control aircraft (Reference C.4.4, p. 33). Decontamination of these aircraft exposed personnel of the Radiation Safety Section of TG 132.4 Test Support Unit (TSU) (TU 132.4.1) to radiation. Apparently the Radiation Safety Section was a small organization of about 10 men, so others may have been required to help in cleaning the many aircraft contaminated in MIKE operations (Reference C.4.5, p. 33). Particulate samples for Projects 1.1 and 1.2 were collected in the wingtank sampling units. They were removed by TG 132.4 personnel under supervision of the project leader, a LASL civilian scientist. Removal of gaseous samples from the snap-bag samplers on the F-84G gundecks for Projects 5.4b and 7.3 was done by another group of personnel and is discussed subsequently. (See Chapter 2 for a detailed description of the sample-removal process.)

Staffing: The maximum exposure from MIKE for a sampler pilot was 3.48 R. Crewmembers of the SA-16 SAR aircraft received exposures of from 10 to 17.8 R. The distribution of recorded exposures of the sampler pilots and the SAR aircraft is shown in Table 19. Recorded exposures for the entire

Air Force SAR element are presented in Table 32 (Chapter 7). The Commander of the Radiation Safety Section received an exposure of 0.023 R for the series, but other decontamination personnel had higher exposures just from work on a single aircraft from another project (Reference C.4.5, p. 33). The recorded exposure of the project leader on the Consolidated List was 0.425 R. No Air Force personnel involved in sample removal can be specifically identified, although unit identification from rosters and film badges is possible.

Project Report: No WT issued.

PROGRAM 2 -- PROGRESS OF THE NUCLEAR REACTION

This program was an investigation of selected sequences in the detonation process to determine rate and timing of various nuclear reactions, and the propagation of reactions through the device (Reference B.1.1, p. 20). All projects were sponsored by the Atomic Energy Commission (AEC) and all were manned by the Naval Research Laboratory (NRL) personnel except Project 2.5, which was sponsored by the AEC, but manned by personnel from Sandia Corporation. Most of the projects were experiments conducted for the MIKE test, except Projects 2.1b and 2.5, which were measurements of the KING weapon performance. Because NRL staffed nearly all projects in this program, personnel exposures for Projects 2.1a, 2.2, 2.3, 2.4, and 2.6 are discussed with the description of Project 2.6.

Project 2.1a -- Alpha of the MIKE Fission

Agency: Naval Research Laboratory

Operations: Signals were fed from instruments just outside the MIKE device case to a recording station 3,000 yards (2.7 km) away on Boken Island (Reference C.0.2, p. B-1). The recovery schedule called for an 8-man team to helicopter to Station 200 on Boken Island for data recovery (see Mission 8, Table 18), but no time was set, and no later record of the time of reentry is available. (See the subsequent discussion under Project 2.6 below for details of this reentry as recalled by radsafe monitors accompanying the recovery.) One man connected with this project was to leave USS Rendova by helicopter 20 minutes after the detonation as part of a larger party bound for Enewetak Island (Table 18).

Although the MIKE detonation heavily contaminated Boken Island (see Table 17 and Appendix C), Enewetak Island was not contaminated during this period. Therefore, the single member of the project team headed there should not have been exposed to radiation.

Staffing: See Project 2.6.

Project Reports: References C.1.3.620, C.1.3.621, C.1.3.622, C.1.3.623, C.1.3.624, and C.1.3.625.

Project 2.1b -- Alpha of the KING Fission

Agency: Naval Research Laboratory (NRL)

Operations: Detectors were placed on the north end of Runit Island, about 2,000 feet (610 meters) from the projected KING surface zero, which was on the reef off the end of Runit. The detector signals were transmitted through cables to Station 250 farther south on the island. Additional detectors were placed near Station 250, and these also transmitted their signals to recorders in Station 250 (C.0.2, p. B-2). The high-priority schedule for KING recovery called for a group of three men to helicopter to Runit for recovery of Project 2.1b data (see Mission 3, Table 21), but no record is available of when they landed on Runit or how long they stayed.

A survey taken from a helicopter flight over Runit about 50 minutes after the KING shot indicated some radiation, with maximum readings near the ground estimated at 3.8 R/hr (see Table 20 and Table C.23, Appendix C).

Staffing: Project 2.1b staffing was apparently interrelated to some degree with the rest of the NRL experiments (Projects 2.1a, 2.2, 2.3, 2.4, and 2.6). In the project report seven NRL civilians were cited as being primarily responsible for carrying out the KING experiments. Of the seven, only four appear on the Consolidated List; their exposures are given in Table 19. The other three apparently did not enter an area requiring a badge.

Project Report: Reference C.1.3.626.

Projects 2.2 through 2.4 -- Propagation of the Fusion Reaction

Agency: Naval Research Laboratory (NRL)

Operations: Gamma rays from the MIKE detonation passed 9,000 feet (2.74 km) through a helium-filled conduit to instruments in Station 202 on Boken Island. The helium-filled conduit (Krause-Ogle Box) leading from the MIKE device to Boken Island was made of plywood sheets sheathed with aluminum siding to protect it from rain. It was lined with building paper, and the helium was retained in a series of plastic ballonets, or envelopes, shown being rolled out inside the box (Figure 17) and after being inflated (Figure 18). Inflation was from cylinders of helium stacked along the length of the structure. Signals from the instruments at Station 202 were then transmitted to recorders at Station 200 (Reference C.0.2, pp. B-3 and B-4). Recovery is described under Project 2.6.

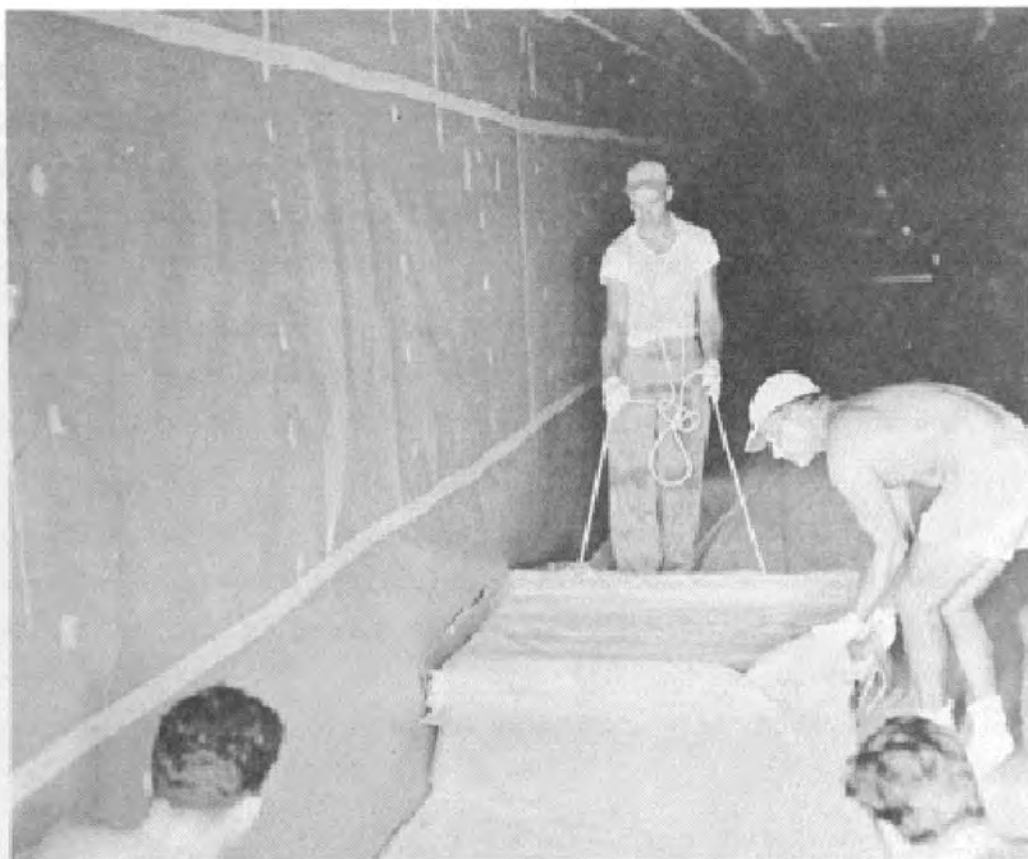

Figure 17. Plastic ballonet being unrolled inside Krause-Ogle box, IVY, MIKE.



Figure 18. Ballonet inflated with helium, IVY, MIKE.

Staffing: See Project 2.6.

Project Reports: References C.1.3.620, C.1.3.621, C.1.3.622, C.1.3.623, C.1.3.624, C.1.3.625.

Project 2.5 -- Measurement of Transit Time

Agency: Sandia Corporation (SC)

Operations: A transmitter in the KING bomb case sent radio signals to receivers in two B-50 aircraft from TU 132.4.2. At the time of detonation, each was at an altitude of 20,000 feet (6.10 km) and at a slant range of 56,400 feet (17.07 km) from surface zero (Reference C.0.2, p. B-3; Reference C.0.1, p. 297).

Apparently the B-50s were not contaminated by the KING detonation, so there should have been no radiation exposure to the crews. (Reference C.4.5, p. 33). Since no samples or exposed film had to be recovered from contaminated areas, the three Sandia men and four Air Force men assigned to the project by TU 132.1.1 should not have been exposed.

Staffing: Four Air Force personnel from the 4925th Atomic Test Group operated the receivers on the B-50s. Each man is listed with an exposure of 0.030 R in the Consolidated List. No other personnel working on this project can be identified.

Project Report: Reference C.1.3.619.

Project 2.6 -- Temperature Measurement by Neutron Spectrum

Agency: Naval Research Laboratory (NRL)

Operations: The helium-filled conduit leading from the MIKE device provided the neutron path for this experiment. Detectors probably were placed in Station 202. No recovery for this project is mentioned in the recovery schedule (Reference B.1.1, pp. 98-99), but was undoubtedly included in the Program 2 recovery tasks (see Table 18).

Information on Program 2 MIKE data recovery was gained from the recollections of two radsafe monitors who accompanied this high-priority mission. The first flew a survey mission on 3 November to Boken Island. He obtained a reading of 27 R/hr while examining the condition for reentry of the bunker at Station 200. He was able to open one door but could not remove the film from the recording cameras inside because of jammed doors on a second door. After returning to Parry, it was decided to make a second recovery effort (Reference C.1.7.6).

A different radsafe monitor was used for the second recovery effort. The exact time of the recovery could not be remembered but the background reading, "the thing that I was supposed to remember," could be remembered. This was 16 R/hr (Reference C.1.7.4). As this was a reading near the ground and as the ground-level reading from Boken cited in the TG 132.1 installment history for MIKE on 4 November was quite close to this value (Reference C.1.2; see also Appendix C), the mission can be assumed to have occurred sometime after the 0800 3 November reading.

On the second attempt the radsafe monitor was accompanied by a man from Holmes & Narver (H&N) and one or two men from Program 2, carrying a cutting torch to open the jammed door. To minimize radiation exposure the helicopter descended and left the cutting torch and one man to work for a

short period of time while the helicopter and the remaining men ascended and hovered out of range of the radiation. After a few minutes, the helicopter descended and another man took the torch while the first man ascended in the helicopter. This rotation continued until the door was cut through and the film collected, after which the helicopter and men withdrew (Reference C.1.7.4). The total exposure that the radsafe monitor accrued in IVY was 2.375 R, which he recollects was almost entirely the result of this mission, and may be considered a representative exposure for this sort of high-priority recovery operation. Plans (Table 18) called for an 8-man recovery operation for Program 2, involving either two trips or a second helicopter, but it is not clear whether this second contingent was necessary.

Staffing: Projects 2.1a, 2.2, 2.3, 2.4, and 2.6 were interrelated in personnel, experimental location, and potential radiation exposure. The report on personnel and administration (Reference C.1.3.636) notes that 96 personnel staffed these projects; 67 were civilians from NRL, 4 were Army personnel, 6 were Air Force, and 19 were Navy. The uniformed personnel probably had NRL as their duty station. Project reports identify 42 (37 NRL civilians, 2 Army, 2 Navy, and 1 Air Force) as working on these projects. An additional three NRL civilians can be identified from the 5x8 cards (Reference C.1.7.3) as working on Program 2. Of these 45, 21 do not appear on the Consolidated List, although in the reports many are cited in such a way that their presence in the field phase is clearly implied. However, they may not have entered an area requiring badging during testing. In addition to the exposures of these badged NRL personnel, the exposures of two LASL civilians, who worked closely with the project, are included in Table 19.

Project Reports: References C.1.3.620, C.1.3.621, C.1.3.622, C.1.3.623, C.1.3.624, C.1.3.625.

PROGRAM 3 -- SCIENTIFIC PHOTOGRAPHY

This program called for photographic documentation of many aspects of both tests. According to Reference C.1.3.636, TU 132.1.1 assigned eight civilians from an AEC contractor, Edgerton, Germeshausen & Grier (EG&G), and three Air Force men to work on Program 3 (see Table 16). History of Operation IVY

(Reference C.0.1, p. 53) lists the program leader as a LASL civilian. Of all these program-level personnel, only his exposure (0.56 R) can be identified on the Consolidated List (Reference C.1.7.2).

Project 3.1 -- Ball of Fire Yield

Agency: Edgerton, Germeshausen & Grier

Operations: For MIKE, 19 cameras were used: 5 on Enjebi, 2 on USS Estes, and 12 on Parry (Reference C.0.2, pp. C-2 and C-3; Reference C.1.9.1, p. 16). The high-priority recovery schedule called for three men assigned to this project to helicopter back to Parry from Rendova 20 minutes after the detonation. Later, two men were to helicopter to Enjebi (see Table 18, Mission 15). The schedule of less urgent recovery activities also called for another two-man team to visit Enjebi by helicopter (see Table 18, Mission 17). For KING, the cameras were mounted on the Parry photo-tower and in Station 302 at the foot of the tower.

Enjebi was 2-3/4 nmi (5.1 km) from the MIKE surface zero. At 1240 on the day of the MIKE shot, a reading of 50 R/hr was taken from a helicopter 150 feet (46 meters) over its center. Estes encountered no early fallout. The ship recorded some minor fallout on gummed paper collectors on 3 November; based on the ship's anchorage position, Parry may have received some as well.

Staffing: Two civilians and two Air Force men can be identified with Project 3.1 activity. Their exposures appear in Table 19.

Project Report: Reference C.1.3.639.

Project 3.2 -- Cloud Phenomena

Agency: Edgerton, Germeshausen & Grier

Operations: Motion picture and still cameras recorded the sizes, shapes, and movement of the shot clouds. For MIKE, project cameras were on Parry, on USS Curtiss and Estes, and on two TG 132.4 C-47s. Both aircraft were at 10,000 feet (3.05 km), one 85 nmi (157 km) south of surface zero and one 85 nmi (157 km) east of surface zero (Reference C.0.1, IVY, pp. 98-99). (Another source gives their positions as 68 nmi [126 km] south-southwest of surface zero at 12,300 feet [3.75 km] and the other 80 nmi [148 km]

east of surface zero at 10,000 feet [3.05 km]. For KING, cameras were operated from Parry and from a C-47 at about 10,000 feet (3.05 km) altitude, 22.7 nmi (42.1 km) south of Enewetak Island (Reference C.0.1, p. 294).

This project per se probably posed little chance of radiation exposure for personnel working on it. Neither Parry nor the C-47s were contaminated by either shot, nor were the C-47s.

Staffing: Personnel conducting this project photography cannot be identified from the project reports.

Project Report: Reference C.1.3.639.

Project 3.3 -- Hot Spot Observation

Agency: Los Alamos Scientific Laboratory (LASL)

Operations: Mirrors directed light from expected "hot spots" on the MIKE device case to cameras in Station 300 on Bokoluo Island (Reference C.0.2, p. C-4). A welder is shown attaching a tube to one of these expected hot spots on the MIKE device in Figure 19, and the tubes leading away from the device toward the mirrors are shown in Figure 20. The MIKE high-priority recovery schedule called for four men to helicopter to Station 300 at an unspecified time after the test (see Table 18, Mission 7). The recovery was probably made on 3 November (D+2) (Reference C.0.1, p. 286).

Bokoluo Island was 3 nmi (5.6 km) from the MIKE surface zero. Readings taken from a helicopter 1,500 feet (457 meters) over Bokoluo at 1300 on shot day varied from 1.2 to 7.0 R/hr (see Appendix C).

Staffing: Joint leaders of this project, both LASL civilians, can be identified; their badge readings were 0.66 and 0.56 R (Reference C.1.7.2). The single Air Force man assigned to this project received 2.726 R, and another LASL man identified with this project received 1.6 R.

Project Report: No WT was issued.

Project 3.4 -- Bomb Case Motion

Agency: Los Alamos Scientific Laboratory (LASL)

Operations: Six cameras housed in Station 300 on Bokoluo recorded the disintegration of the MIKE device case and the initial development of the

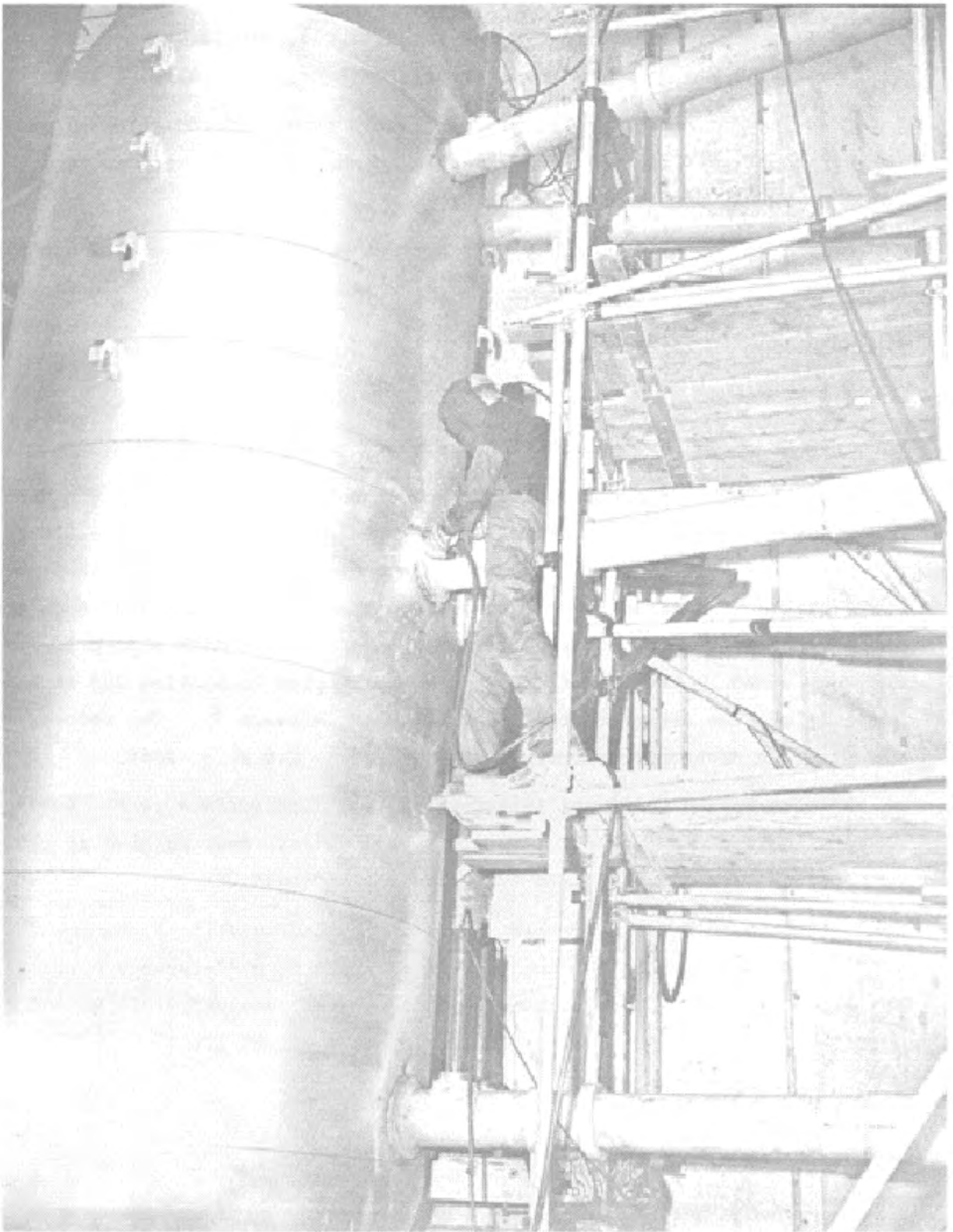

Figure 19. Welder attaching hot-spot tubes to IVY, MIKE device.

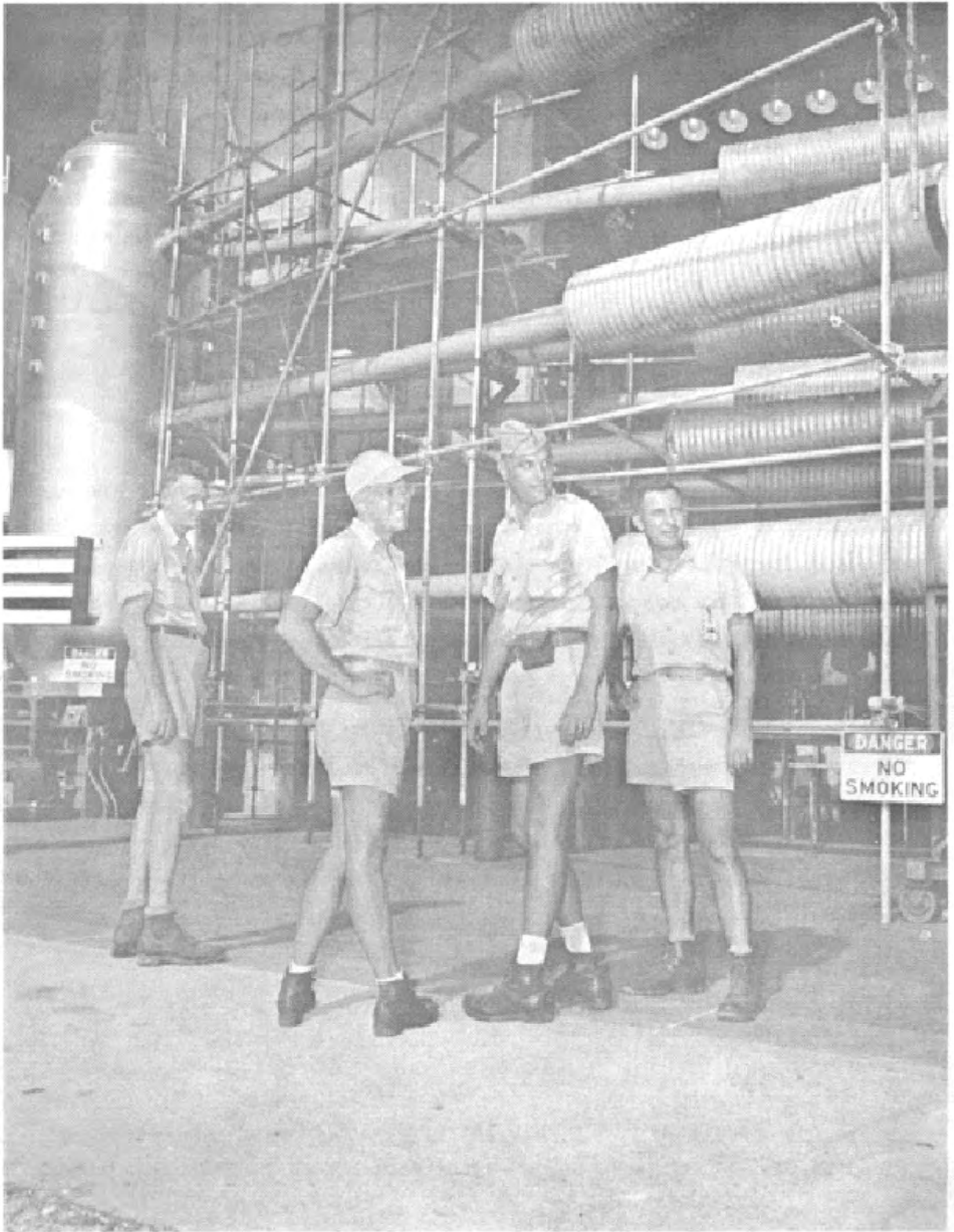

Figure 20. Hot-spot tubes leaving IVY, MIKE device.

fireball. The MIKE high-priority recovery schedule called for a group of four men to helicopter to Station 300 at an unspecified time after the shot. This was a joint recovery with Projects 3.3 and 3.4, and thus was probably done on 3 November. The potential for radiation exposure for personnel conducting this experiment was therefore the same as Project 3.3.

Staffing: Two LASL civilians and an Air Force captain are identified with this project in the 5x8 card file and their exposures are shown in Table 19.

Project Report: No WT was issued.

Project 3.5 -- Illumination as a Function of Time

Agency: Edgerton, Germeshausen & Grier (EG&G)

Operations: Two cameras were mounted on the Parry photo tower (Reference C.0.2, pp. C-5 and C-6). Recovery for this project after MIKE was listed as a secondary priority, with two men scheduled to helicopter to Parry to recover the films exposed for Projects 3.2 and 3.5 (Table 18). The KING recovery schedule called for a four-man helicopter-borne team to recover the film for this program and programs on Runit and Lojwa (Table 21).

Staffing: According to Personnel and Administration (Reference C.1.3.636), TU 132.1.1 assigned only a single Navy man to this project (see Table 16), but he cannot be identified on the Consolidated List. Another source identifies an EG&G civilian, who also headed Projects 3.1, 3.2, and 3.6, as head of this project, but his name does not appear on the Consolidated List either.

Project Report: Reference C.1.3.639.

Project 3.6 -- Bhangmeters

Agency: Edgerton, Germeshausen, and Grier

Operations: For MIKE, four bhangmeters (photo-optical devices that measure fireball yield) were placed on Estes. For KING, five bhangmeters were placed on Parry. Estes recorded some low-level fallout on 3 November; Parry may have received some as well.

Staffing: Staffing was the same as for Project 3.5.

Project Report: Reference C.1.3.639.

Project 3.7 -- Preliminary Photographic Crater Survey

Agencies: Military Air Transport Service (MATS)
Lookout Mountain Laboratory (LML)

Operations: Project photographs originally were to have been taken from an RB-50 aircraft. It developed an engine fire, however, and burned on the runway following a landing at Enewetak on 23 October. A second RB-50 sent from the United States did not arrive until 0500 on 1 November and was not ready for the mission. A C-54G (No. 45-575) aircraft and its crew were borrowed from MATS to substitute for the RB-50 as a platform for a camera crew of 5 men from LML. The aircraft was assigned a shot-time position of 50 nmi (93 km) northeast of Eluklab at 10,000 feet (3.05 km) on a northwesterly heading. Following initial pictures of the MIKE detonation and cloud, it was to photograph the MIKE crater as soon as possible following the shot. About 1 hour after the shot, the plane began its photographic runs. On the third run, it encountered heavy fallout at 2,500 feet (762 meters) and was forced to leave the area and return to Kwajalein for decontamination. Upon landing at Kwajalein, it was found that debris had pitted the windshield, all four propellers were chipped, and decals were scrubbed off the nose and leading edges of the wings. All LML film was ruined by radiation exposure (Reference C.1.7.6). Crater photos were finally obtained on 8 November by the RB-50 after bad weather had prevented the pictures being taken on 2 November by the RB-50 or on 4 November by a C-54 (the RB-50 requiring maintenance that day) (Reference C.1.2, MIKE Installment).

Although the crew of the C-54 acted quickly to leave the danger area and flew its aircraft through rainsqualls to reduce contamination on the way back to Kwajalein, the exposure of the aircraft was calculated to have been 29 R (Reference C.4.4, MIKE Inst, p. 27).

Staffing: All of the 12 men on the aircraft, 6 men from MATS as aircraft crew (with 1 officer acting as radsafe monitor), 5 men from LML as camera crew, and 1 officer from 6th Air Division, MacDill AFB, as Flight Safety

Officer, were issued badges for the mission. One man had a badge reading of 8.6 R, six had badge readings of 10 R, two had badge readings of 11 R, and three had badge readings of 11.6 R. The project leader, an Air Force officer, was not on the C-54; his exposure is given as 0.030 R on the Consolidated List.

Project Report: Reference C.1.3.618.

Project 3.8 -- Burst Position

Agency: Edgerton, Germeshausen & Grier

Operations: Cameras were placed on the Parry photo tower, on Drekatimon, and on Lojwa to document the exact location of the KING burst. Apparently the camera on Drekatimon belonged to NRL. KING recovery schedule called for recovery of film from the cameras on the photo tower 1 hour after the shot. The schedule does not mention recovery of film from Drekatimon (see Table 21).

Neither Parry nor Drekatimon appears to have been contaminated by the KING shot. By 0735 on 17 November, the ground reading on Lojwa was 0.150 R/hr (see Appendix C) probably from MIKE contamination effects.

Project Report: Reference C.1.3.639.

PROGRAM 4 -- NEUTRON MEASUREMENTS

This program was primarily to measure the total number of neutrons arriving at certain points on the ground and, secondarily, to measure the arrival of neutrons as a function of time. TU 132.1.1 assigned six LASL men to the program.

Project 4.1 -- Slow Neutron Observations

Agency: Los Alamos Scientific Laboratory (LASL)

Operations: For MIKE, pairs of detectors were attached to a cable extending from near the shot cab to Louj Island. The first samples were 100 yards (91.4 meters) from the device, and other pairs were fastened at 100-yard (91.5-meter) intervals to a distance of 2,500 yards (2.28 km) (Reference C.0.2. pp. D-1 and D-2). The MIKE high-priority recovery schedule called for eight men to go by boat to Louj and Bokinwołme to pull in

the cable and retrieve the detectors for both Projects 4.1 and 4.2 (see Table 18, Mission 5). The time for this activity was not specified. The eight-man recovery group was divided equally between project and H&N personnel. In addition, there were the boat crews and two radiation monitors. The boats used were an LCM, an LCU, and two DUKWs. Planning called for a caterpillar tractor to pull the cable (Reference B.1.2, p. 23).

The arrangement for KING was similar. The cable with detector pairs started on the reef at the north end of Runit about 100 yards (91.4 meters) from the proposed surface zero and extended along the center of the island to a distance of about 2,400 yards (2.2 km) from surface zero. A group of unknown size was to reenter Runit by boat at 0900 the day after the KING shot to recover data from Projects 4.1, 4.2, 4.4, 5.1, 5.2, and 8.1 (Table 21).

Louj is 1 nmi (1.85 km) from the MIKE surface zero. The plan to use a tractor to pull the cable could not be followed because the MIKE blast had blown the cable and samples into the lagoon. Thus, it was necessary to retrieve detectors individually where they had parted from the cable or wherever they could be found. The recovery party members wore swimming trunks and used swim fins and snorkels. Only the outer detectors were recovered (Reference C.1.7.6). Because detector recovery on Bokinwotme required pulling in the cable and removing the detectors, it could hardly have been a quick operation. The KING recovery group that reentered Runit at 0900 the day after the shot was scheduled to spend about 4 hours in recovery operations for a total of six projects: 4.1, 4.2, 4.4, 5.1, 5.2, and 8.1 (see Table 21). The readings on Runit at 0726 that day were between 0.001 and 0.1 R/hr (see Appendix C.)

Staffing: Six men can be identified from the 5x8 cards as being participants in Projects 4.1 and 4.2. These were three LASL civilians, two Navy officers stationed at LASL, and an Air Force officer from Sandia Base. The leader, a LASL civilian, had a badge reading of 1.9 R. All six identified readings are presented in Table 19.

Project Report: No WT was issued.

Project 4.2 -- High-Energy Neutron Observations

Agency: Los Alamos Scientific Laboratory

Operations: Detectors for this experiment were placed on the cables described under Project 4.1 and recovered in the same way (Reference C.0.2, pp. D-1 and D-2). For a description of this recovery see Project 4.1.

Staffing: Same as Project 4.1.

Project Report: No WT was issued.

Project 4.3 -- Neutron Spectrum Nuclear Emulsions (deleted from the program)

Project 4.4 -- Neutron Intensity as a Function of Time

Agency: Los Alamos Scientific Laboratory

Operations: Devices to measure neutron flux as a function of time were placed on Bokinwotme Island, about 1,200 yards (1.1 km) from the MIKE surface zero. Because the MIKE yield was greater than the estimate used in placing the devices, all were destroyed. The MIKE high-priority recovery schedule called for four men to helicopter to Bokinwotme at H+75 minutes (see Table 18, Mission 6). For KING, the measuring devices were set out on the north end of Runit, but again all were destroyed by the blast. For KING, project data were to be recovered with those of Projects 4.1, 4.2, 5.1, 5.2, and 8.1 (see Table 21, Mission 12). No information is available on when the recovery party reentered the island or how long it stayed. Reentry to Runit after KING should have resulted in little exposure.

Staffing: Individuals for this project cannot be identified.

Project Report: No WT issued.

PROGRAM 5 -- GAMMA-RAY MEASUREMENTS

The program was designed to measure total gamma dose as a function of distance, gamma intensity as a function of time, gamma intensity from fallout, and fallout distribution and particle size. TU 132.1.1 assigned four LASL personnel to the program overall. The program was led jointly by two LASL civilian scientists. Only one exposure, however (2.83 R), was on the Consolidated List (Reference C.1.7.2).

Project 5.1 -- Total Dose

Agency: Los Alamos Scientific Laboratory (LASL)

Operations: For MIKE, two lines of film badges were laid out, one from Eluklab to the far end of Bokoluo, and the other from Eluklab to the far end of Enjebi. Three film badges were placed every 100 yards (91.5 meters) on land. Two of the badges were attached to devices that caused them to drop into shielding receptacles, the first 0.2 second after the explosion and the second 60 seconds later (Reference C.0.2, p. E-1). Retrieval of the film badges for this experiment had secondary priority on the MIKE recovery schedule. A 3-man team was to helicopter to Bokoluo, Bokombako, Kirunu, Louj, Bokinwotme, Eluklab, Dridrilbwij, Bokaidrikdrik, Boken, and Enjebi (Table 18, Mission 19). The KING portion of the project consisted of a line of film badge stations about 100 yards (91.5 meters) apart down the middle of Runit out to approximately 4,000 yards (3.7 km) (Reference C.0.2, pp. E-1 and E-2). Recovery was scheduled to start at 0900 the day after KING by the same team used for recovery in Projects 4.1, 4.2, 4.4, 5.2, and 8.1 during a projected working period of 4 hours (Table 21, Mission 12).

All the islands used for the MIKE portion of this project were radioactive. Reentry to the various islands was determined individually using aerial radiological surveys to map the radiation intensity. Radiation on Runit varied between 0.001 and 0.1 R/hr at 0726 on 17 November, about 20 hours after the KING detonation.

Staffing: Three LASL civilians can be identified from the 5x8 cards as being part of this project; their exposures are reflected in Table 19.

Project Reports: Reference C.1.3.634.

Project 5.2 -- Gamma Intensity as a Function of Time

Agency: University of California Radiation Laboratory (UCRL)

Operations: For MIKE, instruments were placed on Bokinwotme, Louj, Kirunu, and Bokombako. Recovery from Bokombako was by helicopter 3 days after the shot, from Kirunu by DUKW 4 days after the shot, and from Louj by unrecorded means 10 days after the shot. A recovery at Kirunu on 5 November

was recorded by a documentary cameraman from LML; two of his photographs are reproduced here as Figures 21 and 22. The photographer's exposure for the series was 1.29 R. Note the caked soil in front of the bunker, indicating flooding, and the reentry clothing. A recovery party visited the instrument station on Bokinwotme, but information is lacking on the date of their recovery effort and the means of transportation. MIKE recovery had called for helicopter visits to all four islands by a three-man team (Table 18, Mission 9). For the KING portion of the project, three stations on Runit were used at distances of 1,200, 1,700 and 2,200 yards (1.1, 1.6, and 2.0 km) from surface zero. Recovery for this project was combined with the recovery for Projects 4.1, 4.2, 4.4, 5.1, and 8.1 the day after KING. It was expected to take about 4 hours (Table 21, Mission 12).

A ground reading at Bokombako 3 days after MIKE is not available, but at 4 days the reading was 10 R/hr. No ground reading is available for Kirunu before 9 November (8 days after MIKE) when it was 2.5 R/hr, which would probably have made it about 10 R/hr on 5 November (D+4). Ten days after the shot it was between 2.2 and 3.3 R/hr at Louj (Appendix C). At 0726 the day after KING, radiation on Runit varied between 0.001 and 0.1 R/hr (Appendix C).

Staffing: The 5x8 cards show that eight men were involved with Project 5.2. Six were civilians, four from LASL and two from the UCRL. Two naval officers, whose duty station was given as LASL, were the other identified project personnel. Exposures are reflected in Table 19.

Project Report: Reference C.1.3.634.

Project 5.3 -- Fallout Gamma Intensity

Agency: University of California Radiation Laboratory (UCRL)

Operations: Detectors were placed on Bokoluo, Kirunu, Boken, Enjebi, Bijire, Runit, Ananij, Enewetak, Parry, and Biken for the MIKE portion of this project. In addition, stations were placed on Bikini, Majuro, and Ujelang atolls, Kusaie and Ponape islands, and on Kwajalein and Roi islands of Kwajalein Atoll (Reference C.0.2, p. E-4). Recovery for this project was given secondary priority on the MIKE recovery schedule. A two-man team was to helicopter to Bokoluo, Boken, Enjebi, Bijire, Runit, Parry, and



Figure 21. IVY, MIKE recovery on Kirunu, 5 November 1952.

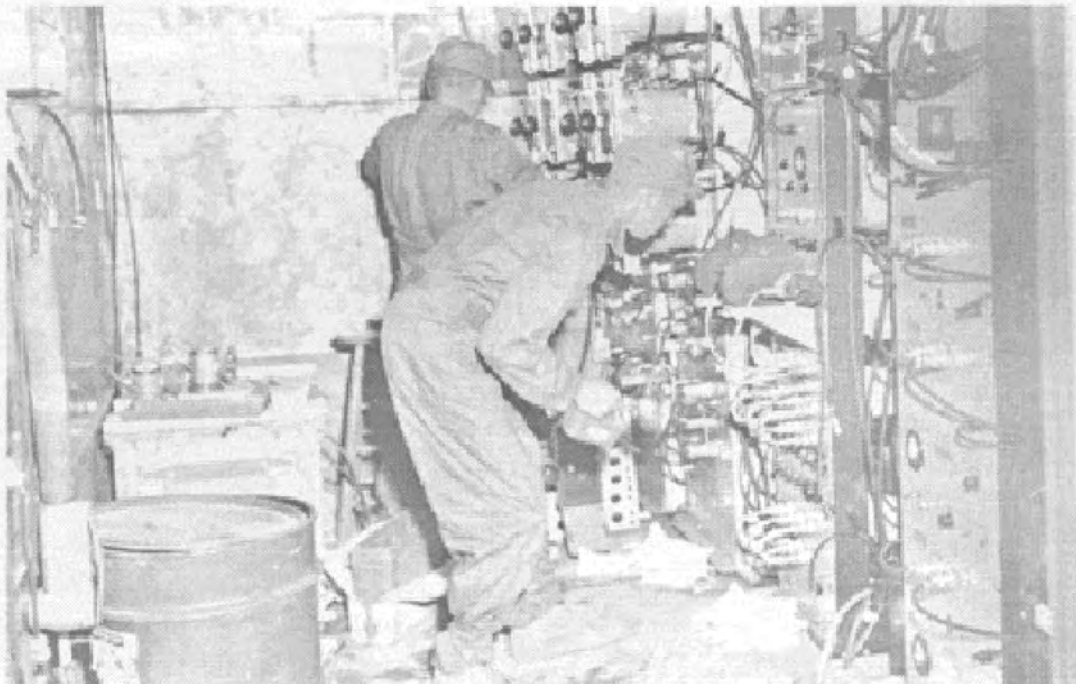

Figure 22. IVY, MIKE recovery team inside bunker on Kirunu, 5 November 1952.

Enewetak islands. No information is available on the method of recovery of data from Kirunu, Biken, and Ananij (Table 18, Mission 20). The arrangement of stations for KING was much the same as for MIKE. New instruments were placed on Bokoluo and Enjebi to replace those damaged by MIKE, but instruments on Boken and Kirunu were not replaced. KING recovery schedule called for the two-man team to helicopter to Bokoluo, Enjebi, Bijire, Runit, Ananij, Biken, Enewetak, and Parry more than 2 days after the shot (Table 21, Mission 22).

Bokoluo, Kirunu, Boken, and Enjebi were heavily contaminated after MIKE but recovery operations for this project had a relatively low priority, and actual recovery was probably not made until 4 days after the shot (see actual recoveries under Project 5.2). Ananij was not contaminated. Enewetak and Parry probably had some low-level contamination from secondary fallout. They lie close to the anchorages of Estes and Rendova; these ships recorded small amounts on gummed paper collectors (Reference D.4). Replacing the instruments on Bokoluo and Enjebi undoubtedly exposed personnel to some radiation, but no record is available about who did this work, when they were on the islands, or how long they were there. KING produced little contamination, and, by 2 days after the shot, decay had lowered the radiation still further. The major source of radiation on contaminated islands was that left over from MIKE.

Staffing: Although Table 16, derived from Reference C.1.3.636, indicates that common personnel were used for 5.2 and 5.3, the 5x8 cards indicate only separate listings. Three men, all from the UCRL, were exposed on this project. Their exposures are given in Table 19.

Project Report: Reference C.1.3.649.

Project 5.4a -- Nature, Intensity, and Distribution of Fallout
from MIKE Shot

Agencies: Naval Radiological Defense Laboratory (NRDL)
Navy Bureau of Ships (BuShips)

Operations: Numerous stations were set out for both MIKE and KING to collect fallout particles for analysis. Land stations were established on Bokoluo, Enjebi, Elle, Billae, Runit, Ananij, Enewetak, and Parry. Twenty

rafts were anchored in the lagoon about 2 weeks before the MIKE shot. Nineteen dan buoys were set out east of the atoll. Gummed paper fallout collectors were put in various locations on ten of the task force ships: Curtiss, Estes, USS Leo, USS Oak Hill, USS Agawam, USS Carpenter, USS Fletcher, USS Radford, USS O'Bannon, and Rendova. USS LST-827, used to evacuate the Ujelang inhabitants, also carried gummed paper, although it was not part of JTF 132. The high-priority recovery schedule for MIKE called for a helicopter to carry an unspecified number of personnel to Bokoluo, Enjebi, Elle, Billae, Runit, Ananij, Enewetak, and Parry for retrieval of samples from the fallout stations (Table 18, Mission 11). LCMs were to carry personnel to pick up samples from raft stations. The rafts were retrieved on 3 and 4 November (Reference C.0.2, p. E-5). Whether the total of men making up the recovery crews was planned to be six or twelve is not clear (see Table 18). O'Bannon began searching for the dan buoys about 0400 on 2 November, the day after the MIKE shot. Twelve of the nineteen buoys set out were recovered; the last of these was found at 0514 on 5 November. Crewmembers apparently took the samples from the shipboard fallout stations.

Land station recoveries for MIKE are given in Table 18. MIKE contaminated the lagoon's waters. TU 132.1.7 analyzed lagoon waters and found no contamination once sediment had settled to the bottom. As a consequence, LCMs, crews, and personnel were not exposed. The radSAFE decontamination requirement was 0.01 R/hr; any level less than this did not require protective actions (Reference C.1.7.5). Twelve O'Bannon personnel and the ship's weather deck were accidentally contaminated on 3 November when the crew brought a radioactive dan buoy aboard. Maximum reading on personnel was 0.001 R/hr on shoes and 0.0005 R/hr on hands. Deck intensity averaged 0.0006 to 0.0007 R/hr. Radiation levels on the deck and on the crewmembers were quickly reduced to 0.0004 R/hr. There were no other instances of accidental contamination during buoy collection (Reference C.3.8, O'Bannon). Amounts of radioactivity in the samples collected by the task force ships and LST-827 are reflected in Appendix C.

Staffing: Nine TU 132.1.1 men can be identified as Project 5.4a participants. Five were NRDL civilians, two were uniformed Navy from NRDL, one

was a naval officer from BuShips, and one was a naval officer from one of the special reporting units at Sandia Base. Their exposures are given in Table 19. Available exposure data from O'Bannon are shown in Table 28 (Chapter 6).

Project Report: Reference C.1.3.615.

Project 5.4b -- Fall-out and Cloud Particle Studies

Agency: Chemical and Radiological Laboratories, Army Chemical Center (ACC)

Operations: Samples were obtained in two ways: by collection stations on 24 of the atoll's islands, plus Unibor, and by the F-84G sampler planes that simultaneously collected samples for Programs 1 and 7 (Reference C.0.2, pp. E-6 and E-7). In addition, daily aerial radiation surveys were conducted using the Air Force H-19 helicopters (Reference C.1.3.615, pp. 105-106). For MIKE, a two-man team was to helicopter to the islands with stations and to bring back 50-pound (22.5-kg) soil samples from each station. Two men were to remain on Enewetak to prepare the samples for shipment (Reference C.1.7.1, p. 98). No record has been found regarding their time of reentry to various islands or how long they spent on each. The same stations were used for KING except those on Bokoluo, Bokombako, Kirunu, and Boken. These were not reactivated because of high background radiation (Reference C.0.2, p. E-7). KING schedule called for recovery on 17 November by a helicopter-borne crew of eight men with work time estimated at 8 hours, with the possibility that more work would be required the next day. According to an after-action report, the samples were retrieved on 17 November. For Project 5.4b, the F-84Gs used collection systems that allowed them to trap both gas and particles. The guns had been removed from each aircraft's gundeck to make room for a polyethylene bag. The pilot obtained the sample by opening a valve that allowed air and particulates to fill the bag through a probe extending from the nose of the aircraft. Upon return to Kwajalein, men from ACC, assisted by Air Force personnel, removed the samples for Project 5.4b. Air Force personnel opened the gundeck and stabilized the bag while ACC men evacuated it through the probe.

The potential radiological exposure associated with F-84G sampler operations at IVY are described under Project 1.3, except those arising from evacuating the polyethylene bags. The pumping operation was governed by detailed procedures designed to prevent exposure of personnel, and there is no record of gas-sample leakage. Apparently all of the ten men on the pumping crew wore radsafe clothing and six used lead gloves.

Staffing: Eight men from the Chemical and Radiological Laboratory of ACC can be identified with this project. Two were civilians, five were uniformed military, and one was not completely identified. Their exposures are given in Table 19.

Project Report: Reference C.1.3.617

PROGRAM 6 -- BLAST MEASUREMENTS

This program was designed to study the characteristics of the MIKE and KING blast and shock waves: their propagation through air, water, and soil, and their transient effects on these media. Apparently, TU 132.1.1 assigned personnel to work on the program as a whole as follows: LASL, 6; Naval Ordnance Laboratory (NOL), 3; Army, 2; Air Force, 2; and Navy, 2 (Table 16). Program directors were an Army colonel detailed to LASL and a Sandia Corporation civilian (Reference C.0.1, p. 53). They show exposures of 1.1 R and 0.89 R, respectively, on the Consolidated List (Reference C.1.7.2).

Project 6.1 -- Pressure Versus Time on the Ground

Agency: Sandia Corporation (SC)

Operations: For MIKE, various types of pressure-recording gauges were placed in scientific stations on Dridrilwij, Bokaidrikdik, Boken, Noah, Enjebi, Mijikadrek, Bokenelab, Aej, Aomon, Runit, and Parry. The lower priority portion of the MIKE recovery schedule called for a four-man helicopter-borne team to retrieve the data from this experiment and several others, namely, Projects 6.3, 6.5, and 6.7b (Table 18, Mission 21). For the KING portion of this project, eight stations were placed on the coral reef along the northwest edge of Runit Island. Another station was on the reef off the northern tip of Parry. Four stations were on Runit Island itself. The KING recovery schedule called for a three-man team to

go to Runit by helicopter 1 hour after the shot to retrieve data for both Programs 6.1 and 6.3 (Table 21, Mission 6). Data recovery involved reentry to many islands that had been contaminated by MIKE (see Appendix C for details). Following KING, less exposure potential existed.

Staffing: Sixteen men can be identified from the project report; 13 civilians from Sandia Corporation, 2 from the Naval Administrative Unit at Sandia Base, and a technical sergeant whose only identification is "Sandia Base." A larger group of 33 Sandia Corporation civilians and 15 military are cited in the project report but do not appear on the Consolidated List. Personnel for this project appear to have been used also to staff Projects 6.3, 6.5, and 6.7b.

Project Report: Reference C.1.3.602.

Project 6.2 -- Air Mass Motion Studies

Agency: Los Alamos Scientific Laboratory

Operations: Smoke puffs were put into the air by exploding shells. Cameras on various islands recorded puff motion in detonation shock waves. For MIKE, both low- and high-altitude puffs were used. The low-altitude puffs were obtained from remotely fired mortar tubes. Four tubes were set out on the reef north of Dridrilbwij, Bokaidrikdrik, and Boken islands. Four were mounted on rafts moored in the lagoon, roughly southeast of Eluklab and west of Lojwa. One mortar tube was mounted on Unibor, and one was on a raft east-southeast of Unibor and west of Runit. A battery of ten 3-inch guns on Enjebi provided the high-altitude puffs. Project cameras for MIKE were on Enjebi, Lojwa, Runit, and Parry. The MIKE high-priority recovery schedule called for one man to helicopter to Enjebi to see if the 3-inch guns had fired (Table 18, Mission 13); this observation was made incidentally by a nonproject monitor in an early mission. During KING, only low-altitude puffs were used. Six mortar-bearing rafts were moored in a line extending from the northern tip of Runit westward into the lagoon. KING cameras were on Lojwa and Parry (Reference C.1.2, MIKE Inst).

One hour after KING, a 4-man recovery party was to visit Parry, Runit, and Lojwa to retrieve data for Projects 3.1, 3.2, 3.5, 3.6, 3.8, 6.2, and 6.13. Recovery time for these projects was estimated at 2 hours. At 0900

the day after KING, a three-man team on an LCM was to remove the rafts from the lagoon (Table 21, Missions 4 and 14).

Staffing: The project officer can be identified as accruing a radiation exposure of 0.4 R, presumably while executing tasks associated with the project. Six enlisted men of the Curtiss are credited with aiding in the project but apparently none was badged; these were possibly the boat crew and raft recovery personnel.

Project Report: Reference C.1.3.627.

Project 6.3 -- Shockwind, Afterwind, and Sound Velocity

Agencies: Sandia Corporation (SC)
Los Alamos Scientific Laboratory (LASL)

Operations: For MIKE, instruments were placed on Bokaidrikdrik, Boken, Enjebi, Mijikadrek, Bokenelab, Aomon, and Parry. Planned recovery is reflected in Table 18, Missions 21 and 23. For the KING portion of this project, three stations on Runit and one on Parry were used. Two recovery missions were planned (Table 21, Missions 6 and 13). Recovery missions were low priority and would not have exposed personnel to high radiation levels.

Staffing: In addition to the personnel of Project 6.1 who manned this project, a LASL civilian and an Air Force officer stationed at LASL worked on Project 6.3. Their exposures are presented in Table 19.

Project Report: Reference C.1.3.603.

Project 6.4a -- Water Wave Motion--Shallow Water Photographs

Agencies: Edgerton, Germeshausen & Grier
Los Alamos Scientific Laboratory (LASL)

Operations: Cameras were installed on Enjebi, Lojwa, Runit, and Parry to photograph arrays of rafts and barrels moved by waves created by the MIKE blast. The recovery schedule does not mention this project but the film was probably recovered with that of Project 3.1.

Staffing: A military officer stationed at LASL is identified in the project report as participating in this project; his exposure is entered in Table 19.

Project Reports: References C.1.3.611 and C.1.3.639.

Project 6.4b -- Sea Waves

Agencies: Office of Naval Research, Washington, D.C.,
and Pasadena, California, Branch Office
Scripps Institution of Oceanography (SIO)

Operations: Instruments were set out at 19 locations to measure sea waves generated by MIKE: Enewetak Lagoon near Runit and Enewetak islands, Seamounts 265 and 72 north of surface zero; two locations on Bikini and Kwajalein atolls; Wake, Truk, Guam, Canton, Yap, and Midway islands; four locations in Hawaii; and two locations in California. MV Horizon recovered the instruments from the two seamounts.

Horizon, with a radSAFE officer from TU 132.1.7 aboard, placed instruments on the two seamounts before MIKE. At shot time the ship was standing by Seamount 72. At 0745 the ship was ordered to get underway on a course of $045^{\circ}T$ at 11.5 knots (21.3 km/hr) for 4 hours. It then started circling on a new station approximately 100 nmi (185 km) north-northeast of surface zero. At 1240 radioactive fallout was detected and the ship was closed up, the ventilation system shut down, and the washdown system started. After sending a message that fallout was being encountered, the ship was ordered to proceed southward. After $2\frac{1}{2}$ hours of steaming at 11.5 knots (21.3 km/hr), Horizon reported that it was clear of the fallout area and that the radiation intensity it had encountered was an average of 0.008 R/hr (gamma only) and a maximum of 0.035 R/hr (gamma only). After leaving the areas of highest activity, the masts above the spray from the washdown system were hosed and the decks were washed down. The radiation levels then decreased to an average of 0.003 R/hr, with a maximum of 0.020 R/hr. By the time Horizon returned to Enewetak on 6 November, the radiation intensity had decreased to an average of 0.00033 R/hr with a maximum of 0.003 R/hr (Reference C.4.2, Document 4, p. 32 ff.).

Staffing: The project report mentions three SIO men, only one of whom appears on the Consolidated List.

Project Report: Reference C.1.3.635.

Project 6.5 -- Ground Motion - Seismic Measurements

Agency: Sandia Corporation

Operations: Instruments were placed on Boken, Enjebi, Mijikadrek, Bokene-lab, Aomon, and Parry. Recovery was to be by a group of four men transported to the project islands by helicopter (Table 18, Mission 21). The time for the mission was not specified but it was a low-priority recovery. Recovery was low priority and probably did not take place when radiation levels were high.

Staffing: See Project 6.1.

Project Report: WT-9004.

Project 6.6 -- Microbarographic Measurements (deleted from the program)

Project 6.7a -- Underwater Pressures as a Function of Time and
Peak Water Pressure as a Function of Distance

Agencies: Office of Naval Research
Naval Research Laboratory (NRL)

Operations: USS Elder set out three deep-water mooring buoys at distances of 1, 1.5, and 2 nmi (1.85, 2.8, and 3.6 km) from MIKE surface zero on the ocean side of the shot island. USS Yuma then attached two instrumented containers to the intermediate mooring buoy, and a single container to the farthest mooring buoy. Because of equipment failure, there was no instrument package for the buoy closest to surface zero. At shot time a P2V patrol aircraft and Curtiss were stationed about 31 nmi (57 km) southeast of the shot island. The P2V intercepted the signals from the two instrumented containers and relayed them to Curtiss. Recovery was attempted 3 days later. Project personnel were aboard Elder on 4 November when it entered the area where the mooring buoys had been secured, but no trace of them could be found. The search ended at 1730 (Reference C.1.3.629, p. 28). On 6 November, USS Arikara located two mooring buoys 155 nmi (287

km) northwest of Enewetak. The ship's crew recovered one buoy, but finding it contaminated, sank the other with rifle fire.

Curtiss did not encounter any fallout as the result of its role in Project 6.7a. Although almost all badged members of Patrol Squadron 2 (VP-2) attached to TG 132.3 had radiation exposures, there is no record of the VP-2 aircraft being contaminated. There is also no record of Elder encountering contamination during the search for the Project 6.7a mooring buoys. On the other hand, when Arikara's crew retrieved the mooring buoy, 12 crewmen were slightly contaminated by the radioactive buoy. The contamination intensity ranged to 0.003 R/hr, far below the radsafe decontamination standard of 0.01 R/hr (Reference C.1.7.5).

Staffing: Five naval scientists, two from NRL, two from NEL, and one from NRDL, were all identified in the project report as participating in the forward area, but none appears on the Consolidated List. Exposures for the supporting naval units may be found in Table 28 (Chapter 6).

Project Report: Reference C.1.3.629.

Project 6.7b -- Underwater Pressures Along the Reef

Agency: Sandia Corporation

Operations: Instruments were placed on 10-foot (3-meter) tripods at a depth of 100 feet (30.5 meters) in the lagoon off Dridrilbwi, Enjebi, Aomon, and Parry for MIKE. Cables ran from the instrument tripods to recording stations on the four islands. A helicopter-borne team of four was to retrieve data for the MIKE portion of this project as well as for Projects 6.1, 6.3, and 6.5 (Table 18, Mission 21). For KING, the instruments in the lagoon off Parry were reused. MIKE recovery was low-priority and KING recovery was at Parry, which was not contaminated.

Staffing: See Project 6.1.

Project Report: Reference C.1.3.605.

Project 6.7c -- Acoustic Pressure Waves in Water

Agencies: Office of Naval Research
Naval Electronics Laboratory
Bell Laboratories

Operations: Several Sound Fixing and Ranging stations in the Pacific and Atlantic oceans were alerted to detect and record any underwater acoustic signals generated by MIKE and KING. A full list of the stations participating is not available. Only stations at Point Sur and Point Arena on the Pacific Ocean are mentioned in the records (Reference C.0.2, p. F-6).

Project Report: No WT issued.

Project 6.8 -- Preshock Arrival Air Temperature (deleted from the program)

Project 6.9 -- Air Density versus Time

Agency: Los Alamos Scientific Laboratory (LASL)

Operations: Instruments were placed on Enjebi, Kidrinen, Bokenelab, and Aomon islands. Distances of these stations from the MIKE surface zero were 19,000, 23,000, 31,000, and 48,000 feet (5.79, 7.01, 9.45, and 14.63 km). Recovery for this project was on the secondary priority portion of the MIKE recovery list (Table 18, Mission 25). Two men with a 3/4-ton truck were to go to the four islands by LCM at an unspecified time after the detonation.

Two of the instrument stations used in this project were covered with coral rock and sand, which probably lengthened the access time of the recovery team. The project report does not, however, indicate their locations.

Staffing: Two Army officers and one Air Force officer stationed at LASL manned this project. Their exposures are presented in Table 19.

Project Report: Reference C.1.3.610.

Project 6.10 -- Free Air Pressure as a Function of Time (Manned Aircraft)

Agency: Air Force Wright Air Development Center

Operations: For both MIKE and KING, two aircraft, a B-36 and a B-47, were used to gather data. They are referred to in much of the literature as the effects aircraft.

At the moment of the MIKE detonation, the B-36 was at 40,000 feet (12.19 km) altitude and 13.5 nmi (25 km) from surface zero. The B-47 was

at 35,000 feet (10.67 km) altitude and 11 nmi (20.4 km) from surface zero (Reference C.0.1, p. 273). At the time of the KING detonation, the B-36 was at an altitude of 32,000 feet (9.75 km) altitude and a horizontal distance of 5.77 nmi (10.69 km) from surface zero, while the B-47 was at an altitude of 35,000 feet (10.67 km) altitude and a horizontal range of 9,800 feet (2.99 km) from surface zero (Reference C.0.1, p. 296).

The effects B-47 was not contaminated during either MIKE or KING. For MIKE, a B-36 was contaminated to a level of 0.15 R/hr according to Air Force records, but probably it was not the effects B-36. A more likely candidate is the control B-36 that guided the F-84G sampler aircraft into the cloud. For KING, three B-36s were aloft, the two used for MIKE and the drop aircraft for the KING bomb. The record shows only that one was contaminated, in this latter case to a level of 0.25 R/hr, but again the most likely candidate was the sampler controller.

Staffing: Travel documents (Form 52WC-20445-A) in the National Archives (RG-374) identify 100 persons by name or by function who were to participate in Project 6.10 or the related Project 8.5. The distribution by organization is as follows:

	Identified on Travel <u>Orders</u>	On Consolidated <u>List</u>
Wright Aeronautical Development Center	18	8
8th Air Force, Carswell AFB, New Mexico		
11th Bombardment Wing Flight Crew	15	13
11th Bombardment B-36 Ground Crew	29	0
2nd Air Force, Barksdale AFB, Louisiana		
B-47 Flight Crew	3	0
B-47 Ground Crew	20	0
Contractors		
Convair Technical Representative	1	0
Boeing Technical Representative	1	0
University of California, Los Angeles	5	3
Allied Research Associates	3	1
Massachusetts Institute of Technology	2	0

	Identified on Travel <u>Orders</u>	On Consolidated <u>List</u>
Aeronautical Ice Research Laboratory, Ypsilanti, Michigan	3	0
Total	100	25

The distribution of the exposures of the 25 persons on the Consolidated List is shown in Table 19.

Project Report: The project report (WT-638) was cancelled, but the B-36 part of the experiment is covered in Reference C.1.3.750, Blast Effects on B-36 Type Aircraft, Upshot-Knothole Project 5.3, March 1955.

Project 6.11 -- Free Air Pressure as a Function of Time Using
Parachute-Suspended Canisters

Agency: Air Force Cambridge Research Center (AFCRC)

Operations: Six parachute-suspended canisters were dropped shortly before both MIKE and KING from two B-29s attached to TG 132.4. The drops were timed to vary canister altitudes when the shock wave arrived from 10,000 feet (3.05 km) for those nearest to surface zero to 30,000 feet (9.14 km) for those farthest from surface zero. The B-29s returned to Kwajalein after dropping their canisters. Oak Hill was positioned to receive telemetry from the canisters. For MIKE, the ship was 30.4 nmi (56.3 km) east of surface zero. For KING, the ship was 19.4 nmi (36.0 km) east of surface zero. During MIKE, four B-29s were used: two for dropping canisters and two as NAVAIID aircraft to guide the F-84G samplers. One B-29 was contaminated to a level of 0.1 R/hr and another to the level of 0.2 R/hr; but it cannot be determined which two of the four they were, although the most likely candidates were the sampler NAVAIID B-29s. During KING, none of the four B-29s used was contaminated. Oak Hill was not contaminated by either shot.

Staffing: Travel documents (Form 52 WC-20445-A) in the National Archives (RG-374) show 60 men slated to staff Project 6.11. Their distribution was as follows:

	<u>Identified on Travel Orders</u>	<u>On Consolidated List</u>
AFCRC (3160th Electronics Group and 6520th Flight Test Group)	42	16
Contractors		
Glenn L. Martin Co., Baltimore, Maryland	9	0
Bendix Aviation, Burbank, California	9	0
Total	60	16

Most of the number badged were designated as B-29 flight crews. Exposures are presented in Table 19.

Project Report: Reference C.1.3.631.

Project 6.13 -- Measurement of Free Air Pressures by Smoke Rocket Photography

Agency: Naval Ordnance Laboratory (NOL)

Operations: Mortars were placed on Runit about 4,600 feet (1.4 km) from the KING surface zero. They were arranged to fire smoke rockets in a fan-shaped pattern so that a camera on Lojwa could record the effect of the detonation shock wave on the smoke trails. One hour after the shot, a team of four men in a helicopter was to visit Lojwa and several other islands to recover data from Projects 3.1, 3.2, 3.5, 3.6, 3.8, 6.2, and 6.13 (Table 21, Mission 4). Placing the mortars on Runit and the camera on Lojwa exposed personnel to some residual radiation from MIKE (See Appendix C). Shot KING appears to have increased contamination levels at Lojwa very slightly, if at all.

Staffing: Four civilians and a naval officer from NOL are identified in the project report but only three were badged. A naval officer from AFSWP was also identified as helping in the experiment. Their exposures are presented in Table 19.

Project Report: Reference C.1.3.613.

PROGRAM 7 -- LONG-RANGE DETECTION

This program was designed to help develop equipment and techniques for detection of nuclear explosions at great distances. Data from the program could

be used to calibrate the equipment developed (Reference C.1.1, p. 12). The program was headed by an Air Force officer whose badge reading for the test series was zero (Consolidated List, Reference C.1.7.2).

Project 7.1 -- Electromagnetic Effects from Nuclear Explosions

Agency: Hq USAF

Operations: Reception equipment in Hawaii, Guam, Alaska, Colorado, and Virginia was used in an effort to detect the electromagnetic pulse created by both MIKE and KING. There was no radiation exposure potential connected with this project's activities because of the distance of the reception stations from the detonation sites.

Staffing: No personnel identified.

Project Report: Reference C.1.3.644.

Project 7.2 -- Airborne Low-Frequency Sound from Atomic Explosions

Agencies: Hq USAF
Army Signal Corps

Operations: Acoustic detection stations were set up in Japan, Hawaii, Alaska; the states of Washington, Arizona and New Jersey; and Washington, D.C. to try to detect low-frequency sound waves generated by both MIKE and KING.

Staffing: No personnel identified.

Project Report: Reference C.1.3.632.

Project 7.3 -- Calibration Analysis of Close-In Debris

Agency: Hq USAF

Operations: Some samples from MIKE and KING for this project were drawn from the polyethylene bags mounted on gundecks of F-84G sampler aircraft and filled during their operations. For MIKE, three of the twelve gas samples from the F-84Gs, and for KING, three of the nine gas samples from the F-84Gs were assigned to Hq USAF for use in Project 7.3. Apparently, the crew that drew the gas samples for Project 5.4b drew them for Project

7.3 (Reference C.1.3.617, pp. 152-153). Air Weather Service WB-29s collected the rest of the samples for this project. All eight of the WB-29s in the proving ground were equipped with filter paper holders (C-1 foil) to collect radioactive particles and four had bottle systems (13/31) to collect gas and water samples. Apparently all were expected to collect samples as part of their duties (Reference C.1.1, p. 7.3.3). Six WB-29s participated in MIKE. WB-29 Nos. 2 and 3 entered the MIKE cloud to gather particulate, gaseous, and water samples. Their time of entry is not available, but they were back on Kwajalein by 1346 (Reference C.0.1, p. 276). WB-29 No. 1 monitored shower activity before the shot. WB-29 No. 4 monitored local weather. WB-29s Nos. 5 and 6 tracked the cloud. Eight WB-29s participated in KING. No. 1 again monitored shower activity before the shot. Nos. 2 and 3 took gaseous and water samples and probably particulate samples from within the cloud. No. 4 monitored local weather. Nos. 5 through 8 apparently tried unsuccessfully to collect samples from outside the cloud, but details of their activities are lacking.

During MIKE, WB-29s Nos. 1, 4, and 5 reported encountering no radiation; nevertheless, four of the WB-29s were later found to be contaminated, three to levels less than 0.5 R/hr and one to 3.3 R/hr. Information is lacking, however, on which of the WB-29s these were. During the KING test, Nos. 4 through 8 encountered no radiation. While penetrating the cloud, Nos. 2 and 3 apparently encountered only small amounts of radiation. Information is lacking on Nos. 1 and 4. None of the aircraft required decontamination. Changing the filter paper in the C-1 foil and emptying the bottle systems probably exposed ground crews to some radiation.

Staffing: Only the project officer can be identified and his badge exposure was zero. Aircraft personnel exposures are presented in Chapter 7.

Project Report: Reference C.1.3.645.

Project 7.5 -- Propagation of Seismic Waves

Agency: Hq USAF

Operations: A worldwide network of seismic stations attempted to detect seismic waves from both MIKE and KING (Reference C.0.2, pp. G-4 and G-5). There was no radiation exposure potential due to project activities as

stations were remote. Although no list of stations is available, all probably were at a considerable distance from the proving ground.

Staffing: Not identifiable.

Project Report: None.

Project 7.5 -- Transportation of Air-Borne Debris

Agency: Hq USAF

Operations: From 2 months before MIKE to 6 months after KING, water samples were gathered weekly at ten locations to detect the presence of any device debris. For 2 weeks after the detonations, samples also were taken daily at Guam and Hawaii. Cloud height and movement were tracked by task force airplanes and ships (Reference C.0.2, p. G-5). Guam and Hawaii were the project sites nearest to the proving ground. Task force support for this project was rendered simultaneously with other tasks; hence, Project 7.5 support did not expose task force personnel and equipment to additional radiation.

Staffing: None identified.

Project Report: Reference C.1.3.647.

Project 7.6 -- Detection of Fireball Light at a Distance

Agency: Hq USAF

Operations: Instruments were positioned on Johnston Island, Kwajalein, and in a C-47 flying over Kwajalein in an effort at long-distance detection of light from the MIKE and KING fireballs. Task force personnel do not appear to have been exposed to radiation purely as the result of this experiment. The C-47 was not contaminated by either shot. There is no record of fallout on Johnston Island.

Staffing: No personnel can be identified.

Project Report: Reference C.1.3.646.

PROGRAM 8 -- THERMAL RADIATION MEASUREMENTS

This program was designed to measure thermal radiation at various distances from the two nuclear explosions. The project leader, a LASL civilian, is not on the Consolidated List (Reference C.1.7.2).

Project 8.1 -- Integral Thermal Radiation

Agency: Naval Research Laboratory

Operations: This project and Projects 8.2 and 8.3 had closely integrated instrument sites, recovery, and personnel. For MIKE, instruments were placed on Bijire, Bokoluo, Aej, Bokenelab, Kidrinen, Enjebi, and Boken islands; on site Noah; and between Enjebi and Boken (Reference C.0.2, p. H-1). A five-man crew equipped with a helicopter and a DUKW were to retrieve data for Projects 8.1, 8.2, and 8.3. Enjebi and Bijire were to have top priority. Retrieval from Bokoluo, Boken, Kidrinen, Bokenelab, Aej, and Parry had secondary priority. A total of 400 pounds (181 kg) of samples or equipment was to be brought back from Enjebi and Bijire (Table 18, Mission 10). During the KING phase of this project, instruments were placed on Parry, Bijire, and Ananij (Reference C.0.2, p. H-1). The KING recovery schedule shows recovery for these projects by helicopter at H+1 (Table 21, Mission 5). Recovery operations required personnel from these projects to be in areas of contamination.

Staffing: The 5x8 cards identify nine men for Projects 8.1 through 8.4. Four were NRL civilians, three were servicemen (two Navy and one Air Force) serving at NRL, and two were from H&N. Their exposures are given in Table 19.

Project Report: No WT issued.

Project 8.2 -- Thermal Intensity as a Function of Time

Agency: Naval Research Laboratory

Operations: Stations on Enjebi and Bijire were instrumented for MIKE. Recovery for that portion of the project is described under Project 8.1. For KING, stations on Bijire were reactivated and instruments were placed on a 25-foot (7.6-meter) tower on Ananij (Reference C.0.2, pp. H-2 and H-3). KING recovery was to be as described under Project 8.1.

Staffing: The same personnel were involved as with Project 8.1, with the addition, according to the 5x8 cards, of a Sandia Base civilian. His exposure is given in Table 19.

Project Report: No WT issued.

Project 8.3 -- Spectroscopy

Agency: Naval Research Laboratory (NRL)

Operations: Instruments were placed on Enjebi, Bijire, and Parry for the MIKE phase of this project. Recovery is covered under Project 8.1. For the KING portion of the project, stations on Bijire and Parry were reactivated. Personnel may have had some radiation exposure while working on Bijire. Recovery is treated under Project 8.2.

Staffing: Personnel for this project were the same as Project 8.1 with the addition of one NRL civilian and one Air Force enlisted man serving at NRL. Exposures are given in Table 19.

Project Report: Reference C.1.3.604.

Project 8.4 -- Air Attenuation

Agency: Naval Research Laboratory (NRL)

Operations: The MIKE portion of this experiment was carried out before the detonation. The KING portion was between the two shots and involved a helicopter with a light source hovering over the projected KING surface zero, while stations on Bijire, Ananij, and Parry recorded the amount of light reaching them. The MIKE phase of this project should not have caused any radiation exposure of personnel. Bijire was contaminated by MIKE, so that work for the KING phase of the project on Bijire exposed personnel to some radiation. MIKE did not contaminate Parry or Ananij (see Appendix C).

Staffing: Project 8.1 personnel plus two NRL civilians, one of whom does not appear in the Consolidated List (see Table 19).

Project Report: Reference C.1.3.604.

Project 8.5 -- Thermal Radiation as a Function of Time in Free Air
Utilizing Manned Aircraft

Agency: Air Force Wright Aeronautical Development Center

Operations: Before MIKE, attenuation calibration tests were conducted using a strong light source at surface zero and an instrumented B-29 to prepare for Project 8.5. During the MIKE detonation, the receiving instruments for the project were carried by the effects B-36 and the effects B-47, which were also gathering data for Project 6.10. Data for Projects 6.10 and 8.5 were gathered at the same time. In preparation for KING, a strong light source was installed on Runit after MIKE reentry and calibration measurements were again taken by the instrumented B-29. During the KING detonation, the effects B-36 and B-47 were again airborne to collect data simultaneously for Projects 6.10 and 8.5. Installing the light source on Runit probably exposed project personnel to some radiation. There is no record of the instrumented B-29 being contaminated. The potential radiation exposure encountered by the crews of the effects B-36 and B-47 is discussed under Project 6.10.

Staffing: See remarks under Project 6.10.

Project Report: No WT issued.

PROGRAM 9 -- ELECTROMAGNETIC PHENOMENA

The projects of this program were designed to detect and measure various electromagnetic phenomena resulting from nuclear explosions. The program was headed by an Army colonel assigned to the staff of JTF 132 (Reference C.0.1, p. 53), whose name does not appear on the Consolidated List (Reference C.1.7.2).

Project 9.1 -- Electromagnetic Signals

Agency: Los Alamos Scientific Laboratory (LASL)

Operations: Recording equipment was operated at Parry Island and Los Alamos, New Mexico (Reference C.0.2, p. I-1). There was no radiation exposure potential in connection with this project's activities.

Staffing: One LASL civilian identified from the 5x8 card file.

Project Report: No WT issued.

Project 9.2 -- Effects on the Ionosphere with Respect to the Propagation of Radio Waves

Agency: Signal Corps Engineering Laboratories (SCEL), 9471st Technical Services Unit (Army)

Operations: A radio receiver was set up on Bikini Atoll. A P2V patrol aircraft 200 nmi (370 km) west of Enewetak broadcast to Bikini. The mid-point of the propagation path, that is, the position where the radio signal would reflect from the ionosphere, was above MIKE surface zero. In addition, the Bikini station attempted to intercept signals sent between Guam and Kwajalein and between Guam and Hawaii. For KING, the P2V broadcast to Bikini as before, but the Guam-to-Kwajalein signals were dropped, and messages from Enewetak were recorded at Bikini. Fallout levels on Bikini and Kwajalein after MIKE are given in Table 24 (Chapter 4). No information is available for fallout on these atolls after KING. There is no record of the P2V being contaminated; however, 66 of the 72 badged members of the patrol plane unit had radiation exposures (Table 28) (Chapter 6).

Staffing: Five officers from SCEL are identified with this project, but none is on the Consolidated List.

Project Report: Reference C.1.3.642.

Project 9.3 -- Investigation of Electromagnetic Radiation Throughout the Radio Spectrum Caused by an Atomic Explosion

Agency: Evans Signal Laboratory (ESL)

Operations: Electromagnetic radiations from both MIKE and KING were detected by stations at Parry, Bikini, Okinawa, Hawaii, California, and New Jersey. Parry received low-level secondary fallout following MIKE. Readings of the minor fallout on Bikini following MIKE is shown in Table 24 (Chapter 4). The other stations were remote.

Staffing: Two civilians from ESL were badged for IVY, but neither received any exposure. See Table 19.

Project Report: Reference C.1.3.648.

Project 9.4 -- Evaluation of Indirect Bomb Damage Assessment (IBDA) Techniques

Agency: Air Force Wright Aeronautical Development Center (WADC)

Operations: Three radar-equipped aircraft gathered data on MIKE and KING for this project. Two were the effects B-36 and the effects B-47, which also participated in Projects 6.10 and 8.5. The third aircraft was a B-50. Each had its radar trained on the detonation. See Project 6.10 for the locations of the effects aircraft. The B-50 was at 25,000 feet (7.6 km) and 45 nmi (83.3 km) from MIKE surface zero at shot time. For KING, the effects aircraft and two B-50s participated. See Project 6.10 for the location of the effects aircraft. The two B-50s were at 20,000 feet (6.10 km) and 9.3 nmi (17.2 km) from surface zero. The B-50s were not contaminated, nor was the effects B-57. A B-36 was contaminated in each shot, but available data do not identify which aircraft these were.

Staffing: Project personnel cannot be identified. For WADC participants, see Chapter 7.

Project Report: None.

PROGRAM 10 -- TIMING AND FIRING

This was a scientific support rather than an experimentation program. It was designed to furnish the various other projects with timing signals needed to start equipment and supply the arming and firing signals for MIKE. An EG&G employee headed the program, but his name does not appear on the Consolidated List (Reference C.1.7.2).

Preparing for MIKE probably did not expose project personnel to radiation, but this may not have been the case for KING. The available documents, however, cast virtually no light on what work project personnel may have done between shots on the atoll's contaminated northern islands between shots.

PROGRAM 11 -- PRELIMINARY GEOPHYSICAL AND MARINE SURVEY
OF THE TEST AREA

Four projects of this program were designed to obtain information on the structure of Enewetak Atoll so that the effects of MIKE could be properly interpreted. One project called for the collection of biological samples before and after the MIKE detonation. A LASL civilian headed the program (Reference

C.0.1, p. 53). His cumulative exposure was recorded on the Consolidated List was 1.725 R for the series (Reference C.1.7.2).

Three of the projects were completed before the MIKE detonation; hence, project personnel were not exposed to radiation in their work. These projects and the organizations (Reference C.0.2, pp. K-1 through K-3; Reference C.0.1, p. 24) involved in them were:

1. Project 11.1 -- Soundings off the Ocean Side of Enewetak Reef

Agencies: Office of Naval Research
Navy Hydrographic Office

2. Project 11.2 -- Scaled Ground Shock Tests

Agencies: Los Alamos Scientific Laboratory
U.S. Coast and Geodetic Survey

3. Project 11.3 -- Deep Drilling to Base Rock

Agencies: Office of Naval Research
Drilling and Exploration Company

Project 11.4 -- Seismic Refraction Survey

Agencies: Office of Naval Research
Scripps Institution of Oceanography
U.S. Coast and Geodetic Survey

Operations: Before MIKE, MV Horizon detonated explosive charges under water while Lipan, trailing a hydrophone, detected and recorded the signals. At the time of the MIKE detonation, Lipan attempted to record the signals produced. Following MIKE, Lipan continued to assist Horizon. The signal from KING was recorded by instruments lowered down the borehole drilled on Parry for Project 11.3. After KING, MV Spencer F. Baird assisted Horizon. Lipan was not contaminated during MIKE. After the shot, however, it again worked with Horizon, and while operating near the MIKE crater, it received the heaviest contamination of any Navy ship (Reference C.3.1, p. 57). This contamination was evident in the ship's systems that came in contact with the lagoon waters. The evaporators for fresh-water production showed 0.0025 R/hr and the anchor chain was radiating at an intensity of 0.020 R/hr after these operations. Horizon was not contaminated on this project, but it had been earlier. It was north of the atoll on MIKE shot day,

after having placed instruments for Project 6.4b. There it encountered fallout from the MIKE detonation. See Project 6.4b above.

Staffing: Project personnel cannot be identified.

Project Report: Reference C.1.3.633.

Project 11.5 -- Marine Survey

Agency: Applied Fisheries Laboratory, University of Washington (AFL)

Operations: Before and after MIKE, plant and animal samples were collected on nine islands and from the lagoon waters near them. Locations and times of postshot activities and radiation levels were:

<u>Location</u>	<u>Date</u>	<u>Radiation Level on Ground (R/hr)</u>
Biken	5 November	0.030
Enjebi	8 November	2.2-2.4
Bokombako	8 November	3.60
Bokoluo	8 November	3.50
Aomon	7 November	0.400 (air reading)
Alembel	7 November	0.100 (air reading)
Runit	6 November	0.025-0.090
Japtan	3 November	---
Ikuren	4 November	---

Staffing: Seven civilians from AFL can be identified with this project, of which six have badge readings in the Consolidated List. Their exposures are given in Table 19.

Project Report: Reference C.1.3.616.

TASK UNIT 132.1.7 ACTIVITIES

This task unit's work was radiological safety and is the subject of much of the material in Chapter 2. In summary, this group provided monitors and decontamination services, film badge development and record keeping, calibration and repair of dosimeters, and other similar services to the task force. Potential for radiation exposure accompanied some of these activities.

The most significant part of the TU 132.1.7 mission was control of entry into contaminated areas. Monitoring, reporting of data, issue of protective clothing, determination of stay-time, and decontamination of personnel and equipment were all part of the controlled operation.

The Deputy Commander of TU 132.1.7 was a radsafe engineer and health physicist assigned for duty with LASL Health Division. Several men of the unit had duty assignments with other units (Reference C.1.7.5).

The task unit was staffed by 5 civilians and 49 military (Reference C.1.3.636) (see Table 16). A group picture taken by a documentary photographer on 23 October shows 41 and the file of 5x8 cards (Reference C.1.7.3) gives the names of 46. These named individuals represent all the services and the AEC. Organizations and the number of men each contributed are listed below:

Army

- Army Chemical Corps (8 military)
- Evans Signal Laboratory (2 military, 1 unidentified)
- 971st OTSU, Army Chemical Corps (1 military)
- 8452nd AAU, Sandia Base (1 military)
- Unnamed unit, Ft. McClellan (1 military)

Navy

- Naval Air Station, Norfolk (1 military)
- ComNavAirPac, San Diego (1 military)
- CINCLANT, Norfolk (1 military)
- Naval Administrative Unit, Sandia Base (1 military)
- Naval Radiological Defense Laboratory, San Francisco (1 military)
- 13th Naval District (1 military)

Air Force

- Hq Air Defense Command (1 military)
- Hq Air Training Command, Scott AFB (1 military)
- AF Cambridge Research Center (1 military)
- 3398th Training Squadron, Keesler AFB (1 military)
- 3882nd School Squadron, Gunter AFB (1 military)
- 435th Maintenance Squadron, Miami (1 military)

Unnamed Unit, Bryan AFB (1 military)
Unnamed Unit, Hunter AFB (1 military)
Unnamed Unit, Francis Warren AFB (1 military)
Unnamed Unit, Chanute AFB (1 military)
Unnamed Unit, Steward AFB (1 military)
Unnamed Unit, Lackland AFB (1 military)
Unnamed Unit, Selfridge AFB (1 military)
Unnamed Unit, Webb AFB (1 military)

Marine Corps

Marine Corps Recruit Depot, Parris Island (1 military)
2nd Marine Division, Camp LeJeune (2 military)
3rd Marine Division (1 military)

Other

Los Alamos Scientific Laboratory (3 military, 3 civilians)
Oak Ridge National Laboratory (1 civilian)
Armed Forces Special Weapons Project-Field Command (1 military)

Exposures for the identified TU 132.1.7 personnel are given in Table 19.

TASK UNIT 132.1.9 ACTIVITIES

This unit provided documentary photographic services for the task force. It consisted primarily of personnel from the Air Force Lookout Mountain Laboratory in Hollywood. The military unit stationed there was the 1352nd Motion Picture Squadron. Table 16 indicates that the task unit had 30 civilians and 35 military (Reference C.1.3.636). Exposures are recorded for 10 men identified in the Consolidated List as "132.1.9" and 15 more as either Lookout Mountain Laboratory or the Motion Picture Squadron. This group's exposures are given in Table 19.

CHAPTER 4 OPERATIONS

MIKE SHOT

Eluklab had been selected as the detonation point for MIKE because it was about the farthest point on the atoll from the Enewetak and Parry base camps. The order of the test events was also dictated by MIKE. KING was large enough to possibly disturb the sensitive instrumentation being prepared for MIKE in the northeastern islands of the atoll and would certainly disturb the work schedules in that area. Major preparations for KING could be finished before the MIKE test and, unlike MIKE, the instrumentation being planned for KING did not include massive arrays requiring precise alignments. Therefore MIKE was to go first (Reference C.1.1, Jan Inst).

Preparations

Preparations for the shot were extensive and meticulous. As usual with nuclear tests, such things as assembly and detonation of device, necessary evacuation of personnel, reentry, and recovery of samples and data records, and radiological safety in general were rehearsed at length. Preparations included extensive practices in the United States that centered on the explosive device assembly and on air operations.

Mechanical portions of the device were fabricated in Buffalo, New York, by American Car and Foundry Industries (ACF). A mockup of the device with dummy material for the high explosives and the critical nuclear materials was assembled in mid-July 1952 in a building in Buffalo that had dimensions similar to the cab being built on Eluklab. The purpose of the construction of the mockup was to familiarize personnel of Task Unit (TU) 132.1.4 with assembly procedures and to see if any redesign of the components was necessary (Reference C.0.1).

The large potential size of the detonation meant that the cloud it produced would rise to great heights; consequently, the cloud sampling would have

to take place at higher altitudes than in previous test series. This, in turn, required jet-powered aircraft to replace the propeller-driven drone B-17s that had been used in Operation GREENHOUSE.

MIKE Evacuation

The expected yield of MIKE caused several concerns, including atoll stability, thermal effects, blast effects, and fallout. For these reasons it was decided to evacuate all personnel from Enewetak and Ujelang atolls. Task force personnel also were at Bikini Atoll to prepare for Operation CASTLE and support the IVY experiment program. USS LST-836 was dispatched to stand by at Bikini to evacuate these personnel if fallout from MIKE became a problem. About 2,500 airmen of Task Group (TG) 132.4, in addition to the men of the naval station and their dependents, were on Kwajalein Atoll. Contingency plans were made to evacuate both groups if MIKE fallout reached the atoll in quantity (Reference C.O.1, p. 257).

On 25 October the task force held a rehearsal for the MIKE evacuation. The task force troop quartermaster supervised the troop quartermasters from each of the four task groups as they conducted a full muster of their personnel. A few of the personnel then were taken in small boats to the evacuation ships lying off shore. After a muster on board the evacuation ships, the personnel were returned to shore. Simulated evacuation exercises were held on 27 and 28 October during the rehearsal for MIKE.

Equipment for which there appeared to be no further use was shipped back to the United States; most equipment was simply stored in or near the main camps on Enewetak and Parry. Equipment taken aboard the evacuation fleet was restricted to that required for task force operations afloat and for some phases of reentry within the first 72 hours after detonation. Most equipment needed for early reentry operations was left near the LCM landing beaches of Enewetak and Parry islands. Small craft were towed to Kwajalein, loaded on USNS General E.T. Collins, USS Oak Hill, or USS Leo, moored in deep water, or sent to sea under the escort of USS Yuma. The two Air Force H-19 helicopters were evacuated aboard USS Rendova, to provide reentry airlift. The Army H-13 helicopters and the Air Force L-17 liaison planes were lashed down or crated on Enewetak Island.

Although only selected equipment was evacuated from Enewetak and Parry islands, all equipment projected for later use was withdrawn from the atoll's northern islands. To leave it there was to risk destruction or heavy contamination. Equipment evacuation from the northern islands began on 27 October. After breakfast on 29 October, the Runit camp was closed completely. Only a small portion of the Dridrilbwij camp was left in service, and facilities for eight men were kept open on Bokoluo. On 31 October, evacuation of equipment from the northern islands was completed. The operational plan called for the last increment of the firing party to depart the shot island on USS Estes in the early hours of 1 November, and the record shows that Estes got underway from the atoll at 0309 (Reference C.3.8, Estes).

An effort was made to return surplus personnel to the United States, thus reducing crowding afloat during the MIKE evacuation. As construction on the scientific stations was completed, some Holmes & Narver (H&N) personnel were returned to the United States or went to Bikini to work on construction for CASTLE, but apparently the departure of personnel from the proving ground was slower than expected because of delays in completion of tasks to which they were assigned.

Personnel of TG 132.1 and TG 132.2, including H&N employees, made up most of those boarding the evacuation fleet for MIKE. Most TG 132.3 personnel were stationed afloat, and most TG 132.4 personnel were stationed at Kwajalein. For evacuation, most of TG 132.2 was assigned to Collins. The first elements boarded on 26 October and the last on 31 October. Most TG 132.1 personnel were assigned to USNS David C. Shanks. They boarded between 29 and 31 October.

According to Operation Plan 2-52, elements of the task force participating in the evacuations were to be distributed as follows (Reference B.0.2, Annex I to Annex T, 8 October 1952, Change 3, p. T-I-1-2):

USS Estes

- Majority of Joint Task Force 132 (JTF 132) headquarters staff
- Military Police Detachment from TG 132.2
- Special Security Detachment of CTG 132.1
- Firing party

- Senior radsafe staff
- 7131st Army Unit
- Hq TG 132.1, including command post, advisory panel, and special project personnel
- Task force Weather Central
- TG 132.2 personnel to help with messing and housekeeping
- 8607th Army Unit

USS Curtiss

- Official observers with liaison officer representing CJTF 132
- Enlisted men from the headquarters element of TG 132.2 acting as orderlies for official observers
- Part of the TG 132.1 advisory, scientific, and technical personnel
- Part of the Coast Guard Loran station contingent
- Special Upper Air Weather Detachment
- Power plant and boat pool personnel from Parry

USS Rendova

- Air elements of TG 132.3 previously stationed ashore, consisting of six Corsair fighters, four TBM-3R single-engine transport aircraft, and five helicopters, with their air and ground crews
- Two TG 132.4 helicopters with their air and ground crews
- Part of the Coast Guard Loran station contingent
- TG 132.1 personnel, including early reentry teams, TU 132.1.7 radiation monitors, and radiological laboratory staff

USNS David C. Shanks

- Most of the TG 132.1 scientific and technical staff and a substantial H&N contingent.

USNS General E.T. Collins

- Remainder of the JTF 132 headquarters staff
- Headquarters detachment of TG 132.2
- TG 132.2 Boat Pool
- TG 132.2 Detection Unit
- Part of the Coast Guard Loran station contingent
- 18th Military Police Criminal Investigation Division
- Counter Intelligence Corps Detachment
- Task element (TE) 132.4.1.1

- 1502-1 Air Detachment of the Military Air Transport Service (MATS)
- 1960-1 Airways and Air Communications Service Detachment
- TG 132.1 personnel, including H&N employees for messing and housekeeping support.

USS Oak Hill

- A small group from TG 132.1
- TG 132.2 troop quartermaster personnel.

USNS Leo

- A small group from TG 132.1
- TG 132.1 troop quartermaster personnel.

Final Preparations

Final assembly of the device took place on the afternoon of the day before the shot; this was completed about an hour before the general evacuation of the task force from the atoll was completed at 1800. After the general evacuation, only Estes and USS Curtiss remained in the lagoon.

At 5½ hours before burst, the arming team completed its work and left Eluklab by aircraft rescue vessel for Estes. Estes then got underway for its shot-time position, leaving the atoll at about H-5 (0215). Curtiss left its anchorage at Eluklab and proceeded to Parry, where the last remaining task force personnel boarded. Curtiss left the atoll at 0359 (Reference C.3.8, Curtiss).

Detonation of the MIKE device was scheduled for 0715 on 1 November Enewetak time, but several last-minute occurrences threatened postponement. SS Hartismere, a British merchant vessel, was detected sailing in the direction of Enewetak into the possible path of fallout. On 31 October, a P2V patrol aircraft was sent to warn the ship off, but the P2V developed engine trouble before reaching Hartismere, and about 2030 made an emergency landing on the already evacuated Enewetak landing strip. The aircraft's crew was flown by helicopter to Rendova waiting in the lagoon, after which the ship put to sea. During the same period, six men assigned to Estes could not be located, but at about 2230 they were found to be aboard Collins. Early on shot day, Hartismere was located by another P2V and diverted to a safe course. The firing party departed for Eluklab at 0300 on shot day. By 0400 all personnel were accounted

for. Curtiss, the last ship in the lagoon, departed at 0405 (Reference C.0.1, pp. 267, 270).

The weather also caused moments of concern in the days immediately preceding the test. Conditions had to provide not only for collection of scientific data, but also for a fallout track that would avoid populated islands, major air and sea routes, and the task force itself. The weather briefing held at 2130 on 30 October showed a very favorable picture. A briefing at the same hour the next day presented a much less encouraging outlook, and the situation deteriorated as the day wore on. At about midnight, however, the wind shifted to a very favorable direction, making it appear as if all fallout would go northward from surface zero. After a weather briefing at 0300 on shot day, the task force commander decided to push ahead with the detonation as scheduled (Reference C.0.1, p. 270).

At the time of detonation, task force ships were arrayed roughly east and south of Enewetak Atoll, with the exception of MV Horizon, located about 65 nmi (120 km) northeast of surface zero. USS O'Bannon was located well to the southeast of the task force sortie area as air control destroyer, helping guide TG 132.4 aircraft between Enewetak and Kwajalein. Radex areas, project instrumentation sites, and positions of task force ships at H-hour are shown in Figure 23.

Missions of TG 132.4 aircraft can be divided chronologically into three groups: preshot, shot-time, and postshot. The mission determined the potential radiological conditions to which flight crews and ground crews were exposed. Preshot missions called for two B-29s and one WB-29. The two B-29s were to drop parachute-retarded, instrumented canisters near surface zero for Project 6.11 shortly before the detonation. The WB-29 was to report any rain-shower activity in the area of surface zero and any significant weather developments in a tract 60 nmi (111 km) long and 20 nmi (37 km) wide, beginning at a point midway between Eluklab and Parry islands, with the long axis upwind from surface zero. The WB-29 made its sweep over Eluklab 20 minutes before detonation and the B-29s parachute-dropped the canisters over the surface zero at 9 minutes before detonation (Reference C.1.2, MIKE Inst).

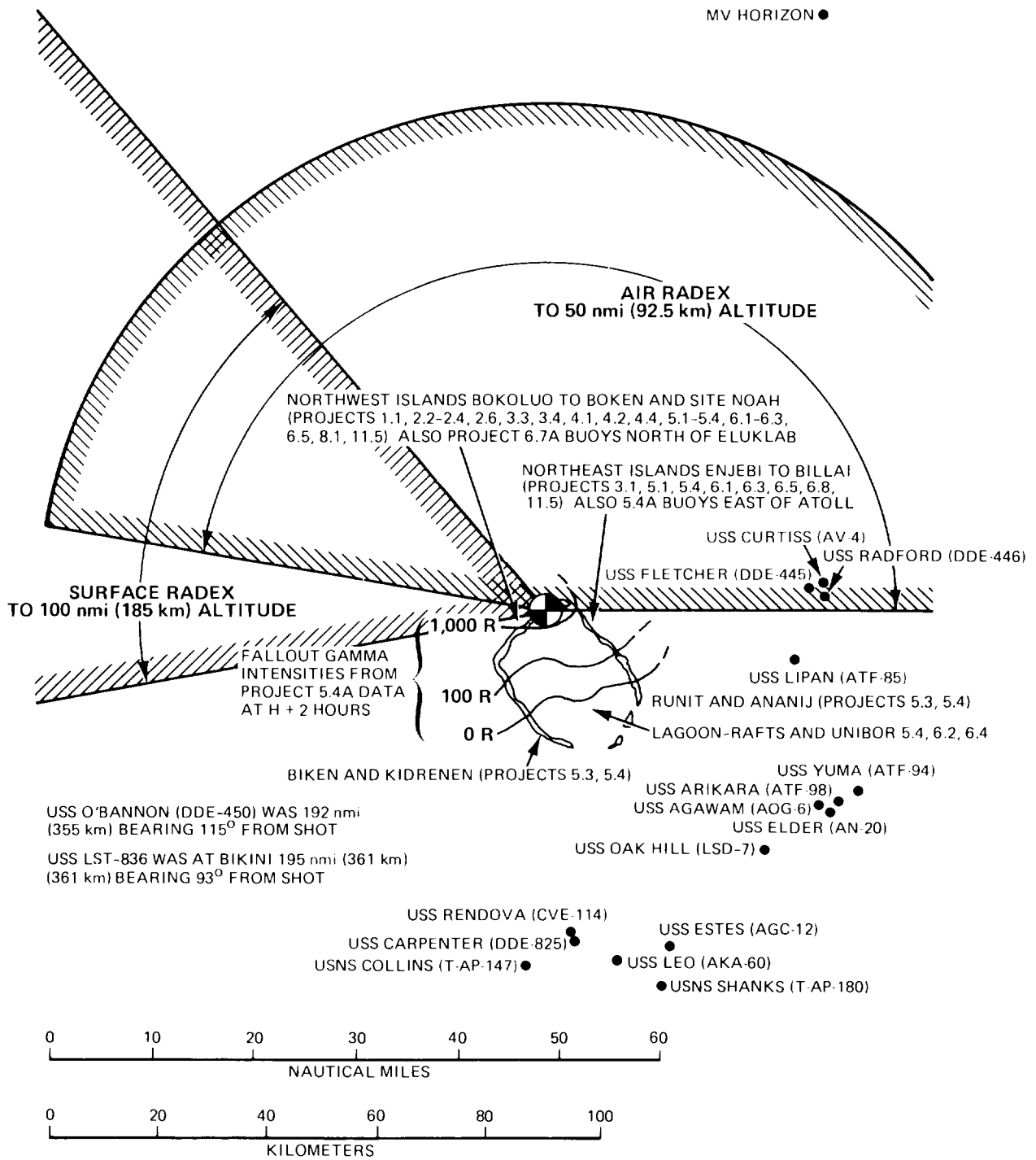

Figure 23. Radex areas, project instrumentation locations, and positions of task force ships, IVY, MIKE.

Six TG 132.4 aircraft had to be precisely positioned at shot time. The effects B-36D and B-47B (Projects 6.11 and 8.5) had to be on a 180° heading south of surface zero at the time of detonation. The B-36D was to be 13.5 nmi (25 km) horizontally from surface zero at 40,000 feet (12.19 km), and the B-47B was to be 11 nmi (20.4 km) horizontally from surface zero at 35,000 feet (10.67 km). To photograph the detonation, three C-54s, with call signs Peter 2, 3, and 4, were to be in position at detonation as follows:

Aircraft	Azimuth from Surface Zero (°T)	Distance from Surface Zero in nmi (km)	Altitude in feet (km)
Peter-2	45	40 (74)	10,000 (3.05)
Peter-3	225	40 (74)	14,000 (4.27)
Peter-4	180	40 (74)	12,000 (3.66)

A B-50 was scheduled to be at 25,000 feet (7.62 km) and at a horizontal distance of 42 nmi (78 km) southeast of surface zero at shot time. The B-50 was to measure air attenuation just before the shot and collect data for indirect bomb damage assessment (IBDA) after the shot (Reference C.0.1, p. 272). Figure 24 shows the positions of the canister-drop B-29s, the photo C-54s, and the effects B-47 and B-36 at shot time.

At shot time, sampler aircraft were in two locations. Orbiting in an area 50 nmi (93 km) southeast of surface zero were two vanguard F-84G samplers and a number of supporting aircraft:

- A B-36 controlling the two F-84G samplers
- A B-29 to control the other aircraft in the area
- Two KB-29 tankers for refueling the F-84Gs
- An SA-16 and an SB-29 for search and rescue (SAR) missions.

Orbiting in an area 50 nmi (93 km) north of surface zero were two WB-29s to collect samples for the Hq USAF sampling program.

To document the size, shape, and rise rate of the MIKE cloud, two additional aircraft -- C-47s -- were airborne, one 85 nmi (157 km) east of surface zero and the other the same distance south of surface zero (Reference C.0.1, pp. 273-274). Table 22 lists participating Air Force aircraft.

PARTICIPATING AIRCRAFT

CANISTER DROP-2 B-29s 36 nmi (66 km)
FROM GROUND ZERO AT 30,000 feet
(9.14 km) ALTITUDE

PHOTO C-54-3 EACH 40 nmi (74 km) FROM
GROUND ZERO AT THE FOLLOWING ALTITUDES:
PETER-2 - 10,000 feet (3.05 km)
PETER-3 - 14,000 feet (4.27 km)
PETER-4 - 12,000 feet (3.66 km)

EFFECTS B-47-11 nmi (20.4 km) FROM GROUND
ZERO AT 35,000 feet (9.15 km) ALTITUDE

EFFECTS B-36- 13.5 nmi (25 km) FROM GROUND
ZERO AT 40,000 feet (12.19 km) ALTITUDE

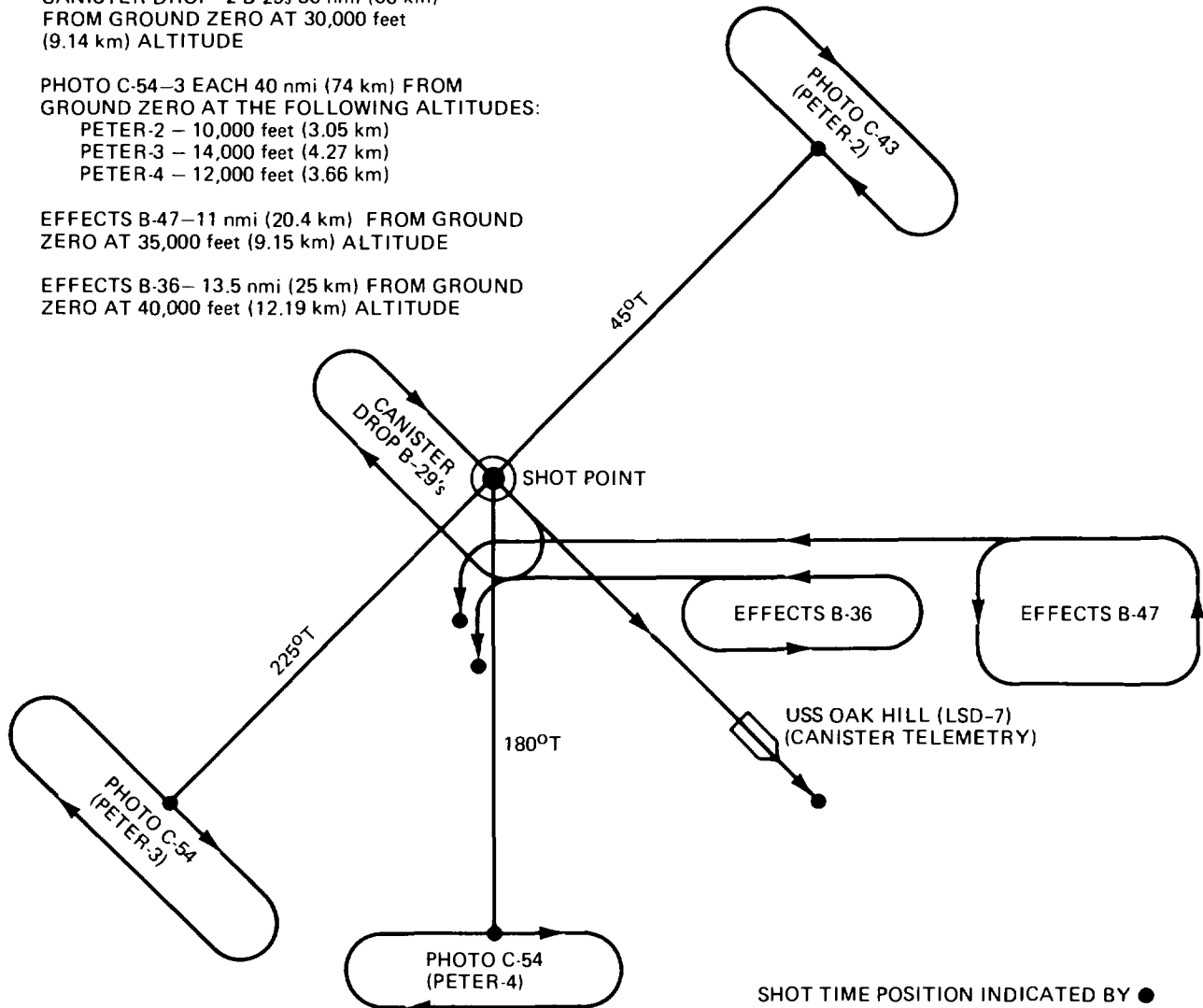

Figure 24. Aircraft and position paths for IVY, MIKE.

Table 22. Air Force mission aircraft participation for IVY, MIKE.^{a,b,c,}

Aircraft (type/no.)	Code word	Mission	Altitude in kft (km)	Range in nmi (km)
WB-29 ^d	William One	Shower activity	1.0 (0.30)	---
WB-29/6399	William Two	Sampler	18.0 (5.49)	50 (93)
WB-29/2163	William Three	Sampler	18.0 (5.49)	50 (93)
WB-29	William Four	Local weather	1.0-22.0 (0.30-6.71)	11 (20.4)
WB/29	William Five	Cloud track/sampling	15.0 (4.57)	---
WB/29	William Six	Cloud track/sampling	15.0 (4.57)	---
B-29	Charlie One	Control	20.0 (6.10)	50 (93)
B-29	Charlie Two	Control	17.0 (5.18)	50 (93)
F-84/1042	Fox One	Sniffer	40.0 (12.19)	50 (93)
F-84/1032	Fox Two	Sniffer	40.0 (12.19)	50 (93)
F-84G/1055	Pebble Red One	Sampler		---
F-84G/1028	Pebble Red Two	Sampler		---
F-84G/1030	Pebble Red Three	Sampler		---
F-84G/1040	Pebble Red Four	Sampler		---
F-84G/1045	Pebble White One	Sampler	30.0 (9.14)	---
F-84G/1038	Pebble White Two	Sampler	to maximum	---
F-84G/1046	Pebble White Three	Sampler	aircraft	---
F-84G	Pebble White Four	Sampler ^e	ceiling	---
F-84G/1053	Pebble Blue One	Sampler		---
F-84G/1049	Pebble Blue Two	Sampler		---
F-84G/1053	Pebble Blue Three	Sampler		---
F-84G/1043	Pebble Blue Four	Sampler		---
B-50	Item One	Instrument (IBDA)	25.0 (7.62)	42 (78)
B-36	Dog Two	Sampler control	40.0 (12.19)	50 (93)
B-36/49-2653A	Easy One	Effects	40.0 (12.19)	13.5 (25)
B-47/50-037	Easy Two	Effects	35.0 (10.67)	11 (20.4)
B-29/45-21863	Easy Three	Effects (canister)	30.0 (9.14)	36 (66)
B-29/44-84035	Easy Four	Effects (canister)	30.0 (9.14)	36 (66)
RB-50	Peter One	Photo ^f	20.0 (6.10)	>40 (74)
C-54	Peter Two	Photo	10.0 (3.05)	40 (74)
C-54	Peter Three	Photo	14.0 (4.27)	40 (74)
C-54	Peter Four	Photo	12.0 (3.66)	40 (74)
SA-16/1016	Sugar One	SAR	---	---
SA-16/1021	Sugar Two	SAR	---	---
SB-29/0119	Sugar Three	SAR	---	---
SB-29/9957	Sugar Four	SAR	---	---
C-47	Saltshaker One	Administrative		
C-47	Saltshaker Two	Administrative		
C-47	Saltshaker Three	Administrative		
B-17	Saltshaker Five	Administrative		
H-19	Rufus Five	Local SAR	---	---
C-97	Stagecoach One	VIP	Departed area for	
C-121	Stagecoach Two	VIP	Hickam after shot	

Notes:

^aLocations shown are at detonation time.

^bPositions and code words per References B.4.2 and B.4.3.

^cActual positions, "Critique on MIKE Shot" Ltr, dated 4 Nov 52.

^dReference C.4.8

^ePebble White Four took off but aborted because of refueling problems.

^fAircraft arrived at Kwajalein too late for mission.

MIKE Detonation

MIKE was detonated on Eluklab Island at 0714.59.4 on 1 November, approximately 0.6 second early because of a power failure aboard Estes where the firing party was stationed. The 10.4-MT blast produced a tremendous fireball followed by a gigantic mushroom cloud. The description of the event by the author of History -- Task Group 132.1 (Reference C.1.2) and reproduced in History of Operation IVY (Reference C.0.1, p. 274) bears repeating.

The Shot, as witnessed aboard the various vessels at sea, is not easily described. Accompanied by a brilliant light, the heat wave was felt immediately at distances of thirty to thirty-five miles. The tremendous fireball, appearing on the horizon like the sun when half-risen, quickly expanded after a momentary hover time and appeared to be approximately a mile in diameter before the cloud-chamber effect and scud clouds partially obscured it from view. A very large cloud-chamber effect was visible shortly after the detonation and a tremendous conventional mushroom-shaped cloud soon appeared, seemingly balanced on a wide, dirty stem. Apparently, the dirty stem was due to the coral particles, debris, and water which were sucked high into the air. Around the base of the stem, there appeared to be a curtain of water which soon dropped back around the area where the island of Elugelab [Eluklab] had been.

The shock wave and sound arrived at the various ships approximately two and one-half minutes after the detonation, accompanied by a sharp report followed by an extended, broken, rumbling sound. The pressure pulse and the reduced pressure period as received by ear were exceptionally long.

Although the upper cloud first appeared unusually white, a reddish-brown color could soon be seen within the shadows of its boiling mass as it ascended to greater height and spread out over the Atoll area. At approximately H+30 minutes, the upper cloud was roughly sixty miles in diameter with a stem, or lower cloud, approximately twenty miles in diameter. The juncture of the stem with the upper cloud was at an altitude of about 45,000 feet. Numerous projecting fingers could be observed in the neighborhood of the juncture of the stem with the upper cloud. Though later evidence questioned the accuracy of the readings and indicated lower heights, the preliminary cloud-rise data prepared shortly after the detonation indicated the following for the top of the mushroom at various time intervals:

<u>Time in minutes</u>	<u>Height in feet</u>
H+1.5	57,000
H+2.6	108,000
H+3.4	110,000
H+5.7	118,000

The cloud had ascended very rapidly and soon appeared, in the words of one observer, to have "splashed" against the tropopause. After approximately fifty-six minutes, the entire cloud appeared to have become stabilized at an altitude of over 120,000 feet, though this figure was later questioned also. By this time, deforming effects by winds were becoming apparent though as late as sunset on M-Day distant and high portions of the cloud could still be observed.

The heat generated by the detonation charred the leaves of plants as far away as Bijire. Wave action and blast winds had cleared debris from Enjebi and wave washing was apparent at Kidrinen. The closer islands, Boken, Bokaidrikdrik and Dridrilbuij, were completely swept clear (Reference C.1.2, MIKE Inst). The blast destroyed Eluklab Island, leaving a submerged crater about 6,300 feet (1.9 km) in diameter and 160 feet (49 meters) deep, large enough to hold 14 buildings the size of the Pentagon (Reference C.0.1, p. 274).

About one-half hour after the detonation, a wave of water reached Enewetak Island whose trough-to-crest height was about 3 feet (1 meter). In the next 5 minutes several smaller waves attributable to the blast reached Enewetak Island (Reference C.1.2, MIKE Inst).

Reentry into Enewetak and Parry

Task force reentry onto Enewetak Atoll had been planned in detail (Reference B.0.5), but only a radiological survey could serve as a dependable guide for the actual reentry. At 0720, 5 minutes after the detonation, helicopter No. 28 was launched from Rendova to survey the islands of the atoll. The helicopter was to fly over the center of each island on a line with the chain of islands at a height of 25 feet (8 meters) and a speed of 30 knots (56 km/hr). An instrument man with an AN/PDR-T1B survey meter was to sit by the helicopter's door with the meter between his knees. At 5-second intervals, he took readings, recording only the greatest one for each island (Reference C.3.8, Rendova; Reference C.1.3.617, pp. 109-110).

Over Enewetak and Parry, the survey team detected no radiation, but it found Runit radioactive. About 40 minutes after the detonation, while in the vicinity of Billae Island, 4 nmi (7.3 km) southeast of the crater, the helicopter was contaminated by muddy rainout and the survey was terminated. At 0821, upon its return to Rendova, parts of the helicopter showed residual contamination of 2 R/hr (Reference C.1.7.1, p. 37) that was soon washed off (Reference C.1.7.5). A second attempt was not made until 4 hours after the detonation.

A second helicopter left Rendova 15 minutes after the shot to recover films from the camera tower on Parry Island. Apparently on the basis of the quick radiation survey of Enewetak and Parry islands, or word from the film recovery helicopter, an 8-man reentry party, TE 132.4.1.1, was flown ashore in an Air Force H-19 helicopter about 40 minutes after the shot to reopen the Enewetak airstrip on a limited basis. Once reopened, about 2 hours after the detonation, the airstrip could be used for emergency landings by aircraft taking part in postshot activities. Another helicopter took H&N personnel to check refrigerators and other mechanical items on Parry (Reference C.0.1, p. 279).

At 30 minutes after the shot, maneuvering for cloud-sample collection began. The two sampler WB-29s remained north of the visible cloud. When the cloud had dissipated to the extent that sampling for Project 7.3 could start without overcontamination, the WB-29s started operations. Just when the actual sampling was done is not clear, but both WB-29s were back on Kwajalein by 1346 (Reference C.0.1, p. 276).

The control B-36 took a position downwind of the MIKE cloud at about 40,000 feet (12.2 km). It then directed the two F-84G sniffers (sampler aircraft doing a preliminary sampling of the cloud) in an initial survey of the cloud.

Twelve additional samplers (one of which aborted because of refueling problems) were divided into three flights: Red, White, and Blue, scheduled to penetrate the cloud in that order at from 42,000 to 44,000 feet (12.8 to 13.4 km) altitude. Red flight arrived in the operational area and began sampling about 1-1/2 hours after the shot. White flight sampled about 2-1/2 hours

after the shot and Blue flight's sampling was done from 1 to 2 hours following that. Three additional KB-29 tankers arrived from Kwajalein to support the F-84Gs approximately 2 hours after the burst. Air-to-air refueling was conducted in the area of 165°E and 10°30'N, about 150 nmi (280 km) east-southeast of Enewetak, over the air control destroyer, O'Bannon.

The sampling operations were northwest of Enewetak Atoll, as the cloud drifted in that direction. The distances from the atoll are not well documented, but the Red samplers were about 95 nmi (175 km) from Enewetak after sampling (Reference C.0.1, p. 277). These F-84G samplers required one or two aerial refuelings to make the return flight to Kwajalein, one in the sampling area and the second, if necessary, over O'Bannon. If the samplers were unable to find the KB-29 tanker and their own fuel was down to 1,000 pounds (460 kg) or about 50 minutes flight time at 40,000 feet (12.2 km), the samplers were to land on the airstrip at Enewetak Island, which was reopened at H+2 for this reason.

Samplers Red 3 and Red 4 did have difficulty with their navigation aids and ran low on fuel. Red 3 was successfully guided back to Enewetak and landed there with empty fuel tanks. Red 4 had been instructed by CTG 132.4 from Estes to fly to Enewetak and was given the heading of 116° by the team that had reopened the Enewetak control tower. Red 4 was believed to have 400 to 500 pounds (180 to 225 kg) of fuel at that time. Helicopters from Rendova had meanwhile been alerted.

Enewetak tower gave Red 4 a second heading at which time Red 4 gave his altitude as 19,000 feet (5.8 km) and indicated his fuel gauges read empty although his engine was still running. Red 4 then called the tower to report that his engine had flamed out; he was at 13,000 feet (4 km) altitude. At 10,000 feet (3 km) he reported the atoll in sight, and at 8,000 feet (2.4 km) altitude the tower gave him another bearing to steer to. At 5,000 feet (1.5 km), the pilot told the tower he could not make the airstrip and that he planned to bail out when the plane dropped to 2,000 feet (610 meters) altitude. At 3,000 feet (1 km), he gave his last transmission, "I have the helicopter in sight and am bailing out."

The helicopter first spotted the F-84G at an altitude of 500 to 800 feet (153 to 244 meters) about one-half mile north of Ikuren. The helicopter pilot observed the F-84G drop its wing tanks and possibly eject the cockpit canopy also. Red 4 then flew into the water in a level glide, seeming to be under positive control. The helicopter arrived over the sinking plane (approximately 3.4 nmi [6.3 km] from the approach or west end of Enewetak Island) about 1 minute after it hit the water, at about 1030. The F-84G had flipped over when it hit. The pilot was never found (Reference C.0.1, p. 277-278).

An SA-16 SAR amphibian had been notified to join the search for the sampler. This plane was flying "on the opposite side of the Shot area" (presumably north of the atoll) and took a direct path to the search area, crossing the fallout region. During this flight the aircraft accumulated between 20 and 25 R, and a crewmember received 17.8 R, the highest exposure recorded during the test series (Reference C.0.1, p. 279).

Testimony of one of the sampler pilots indicates that high radiation levels and the red, furnace-like glow inside the MIKE cloud may have caused some anxiety among the men flying the F-84Gs (Reference C.0.1, p. 277). Exposures among the Red flight pilots were 3 to 4 R, among the White 0.5 to 1.0 R, and among the Blue 0.2 to 0.4 R (Reference C.1.2, MIKE Inst).

The MIKE cloud had moved slowly to the northwest after the shot and heavy rainshowers were observed, mainly around the lower cloud stem. A C-54 photo aircraft was heavily contaminated (29 R/hr) as it flew over the northern islands of the atoll on a mission to photograph the crater that had been formed. The C-54 was at an altitude of about 2,500 feet (763 meters) about 90 minutes after the shot when it flew through a cloud of particles, some as large as split peas. The plane returned directly to Kwajalein, flying through rain-squalls on the way in order to wash off the particles. Cockpit radiation intensity was 0.74 R/hr after the flight through these squalls, and the intensity in the cargo area of the aircraft was 0.2 R/hr (Reference C.4.4, MIKE Inst). Crew exposures were from 8.6 to 11.6 R by the time the plane returned to Kwajalein at 1120 (Reference C.1.7.2). The mission had been scheduled for H+2 at 5,000 feet (1.5 km) or above and the C-54 had arrived too early and was too low (Reference C.1.7.1).

When MIKE was detonated, Horizon was standing by wave instruments anchored at Seamount 72, approximately 72 nmi (133 km) north of surface zero. At 0745 the ship was ordered to get underway for a new position approximately 100 nmi (185 km) north-northeast of surface zero. At 1240, after reaching the new position the crew detected fallout. The ship was closed up, and the washdown system started. CJTF 132 ordered the ship southward, and after about 2½ hours of steaming at 11.5 knots (21 km/hr), the ship reported that it was clear of the fallout.

The radiation encountered averaged 0.008 R/hr (gamma only), with a maximum of 0.035 R/hr (gamma only). The masts above the spray from the washdown system showed the greatest radioactivity. After these were hosed and the decks washed down, the radiation levels decreased to an average of 0.003 R/hr with a maximum of 0.02 R/hr. On 6 November, when Horizon returned to Enewetak, the radiation intensity had decreased to an average of 0.0004 R/hr, with a maximum of 0.003 R/hr (Reference C.3.6).

At H+4 a combined damage and radiological survey helicopter was launched. It returned in about 1 hour, reporting readings on an AN/PDR-T1B meter in the helicopter at 150 feet (46 meters) altitude above the center of Enjebi were greater than 50 R/hr. Similar readings, 500 feet (150 meters) above the blockhouse on Boken were 10 R/hr and above Bokoluo at 1,500 feet (458 meters), 2.5 R/hr (Reference C.1.7.1).

A survey of lagoon water started between 4 and 7 hours after the MIKE detonation. A helicopter made a pass across the lagoon on an east-west line between Runit and Biken islands, taking water samples from the surface and from a depth of 30 to 35 feet (10 meters). Another pass was made northwest from Drekatimon toward the MIKE surface zero as far as radiation levels permitted. Samples were also taken at Deep Entrance, in the anchorage areas, and in Wide Entrance. No contamination was found in the southern half of the lagoon (Reference C.0.1, pp. 279 and 281). Results of subsequent water-sampling operations are shown in Table 23.

The survey helicopters became contaminated with radioactive materials during their flights. The initial survey helicopter, launched at about 10 minutes

Table 23. Lagoon contamination, IVY, MIKE.^a

Date	Lagoon Locations ^b																Enewetak Anchorage			
	Deep Entrance				Wide Entrance				Southwest Passage				WSW To ENE Line Through Lagoon Middle				Off Runit	SS	S	SS
	S	SS	S	SS	S	SS	S	SS	S	SS	S	SS	S	SS	S	SS				
																	Midpoint	Lagoon Center	Midpoint	Midpoint
1 Nov	0	0	0	0	0	1,110	945	1,405	3,350	980	945	22,125	27,150	0	0	0	0			
2 Nov	0	0	0	0	197	298	1,435	940	1,698	1,535	4,180	4,455	12,100	12,150	0	0	0			
3 Nov (a.m.)	0	0	0	0	0	0	0	1,065	1,380	520	775	83,500	90,500	0	0	0	0			
3 Nov (p.m.)	0	0	0	0	0	240	306	452	485	500	610	96,750	98,500	0	0	0	0			
5 Nov					0	0	0	583	378	2,963	906	13,428	833							
6 Nov	111	0	92	261	118	123	277	0	708	6,740	788	442	20,000	12,550	0	9	0			
7 Nov	0	0	0	0	0	0	0	0	363	262	0	0	91	2,785	277	8	0			
8 Nov					0	0	0	0	240	125	460	500	1,865	17,027						
9 Nov					0	0	0	0	240	187	860	720								
12 Nov	0	0	0	0	0	0	0	0	225	284	1,620	1,975	1,440	760						
17 Nov	81	0	0	0	343	137	960	298	448	685	1,080	1,080	186	173						

Notes:

^aAll measurements expressed as counts/minute/milliliter of beta radiation.

^bS denotes surface sample; SS denotes subsurface (30 feet [9 meters]) sample.

Source: Reference C.1.7.1, p. 62.

after the detonation, returned at H+65 minutes with a maximum gamma radiation intensity of 0.4 R/hr. At the end of two more flights to the shot area, contamination had collected to 0.5 R/hr at H+8. Shipboard decontamination reduced the radiation to 0.12 R/hr at H+10. Another helicopter was launched at H+2:20. It returned to Rendova at H+4:30 with a maximum gamma radiation of 1 R/hr. After sitting on the after-end of the flight deck, the radiation had decreased to 0.9 R/hr at H+5:45. Shipboard decontamination reduced the radiation to 0.4 R/hr at H+9 and 0.25 R/hr at H+13 (Reference C.3.11).

Maximum intensity in the interior of Rendova was 0.035 R/hr at H+4:30. This reading was taken on the hangar deck directly below the parked helicopter. On D+3, the contaminated helicopters were based ashore and there was no significant indication of radiation above the background level in the area aboard ship where the helicopters had been parked (Reference C.3.11).

On the night of 1 November, the commander of the joint task force set 0900, 2 November, as the tentative time for general reentry. At 0800 on 2 November, the CTG 132.2 and the task group radSAFE officer helicoptered ashore from Collins. Task force ships reentered the lagoon at about 0954, and by 1110 elements of TG 132.2 and the H&N Enewetak Island contingent started ashore by boat. The airfield was open on a limited basis by 1200, although it is not clear what the status of the field had been after its initial reactivation the day before by TE 132.4.1.1. By 1230 the island's power and telephone systems were operational. By 1600 all facilities on the island had been essentially reactivated (Reference C.2.1, p. IX-1). By D+4 all units of TG 132.1 were ashore (Reference C.1.2, MIKE Inst).

Early on the morning of 2 November, 24 hours after the detonation, a relatively complete helicopter survey of the atoll was finished. It showed radioactivity on all northern and western islands. Only Jinedrol, Ananij, Jinimi, Japtan, Enewetak, and Parry were found to be free of radioactivity. The readings were taken at 25 feet (8 meters) and multiplied by three to get an estimated radiation rate at the surface (Reference C.1.7.1, p. 37).

Reentry and data recovery near the shot island were apparently done 2 and 3 days following the shot, when radioactivity had decayed enough to spend a

few minutes at instrument stations before possible overexposure (Reference C.0.1, p. 286). A particular data recovery mission at Boken for Program 2 is discussed in some detail in Chapter 3.

Blast damage on Enewetak Island was limited to the B-29 hangar, which was distorted slightly so that its doors would not close (Reference C.0.1, p. 281), although it was still usable. No primary fallout occurred on Enewetak Island, and personnel cleared to return there by TU 132.1.7 (Reference C.1.7.5).

Personnel from TG 132.1 were on Parry by about 1045 on 2 November. Since blast damage there was superficial and no fallout to that time was recorded, reentry went smoothly, although it may have gone a bit more slowly than on Enewetak. Parry was declared free of radiation by TU 132.1.7, but some TG 132.1 personnel remained aboard ship for several days, primarily because some support facilities had not been reactivated (Reference C.1.2, MIKE Inst).

Although Enewetak and Parry were free of fallout and water samples revealed no contamination in the southern part of the lagoon, the picture was the reverse to the north. Thus, all traffic north of Parry had to be cleared through the radsafe control point in Building 57 on Parry (Reference C.0.1, p. 281). Two days after the burst, Parry-based personnel were able to undertake final preparations on Runit, and were served lunch there from an H&N chuckwagon. No one, however, stayed there overnight (Reference C.1.2, KING Inst).

Cloud tracking began in the evening of MIKE shot day. The first WB-29 cloud-tracking plane took off from Kwajalein at H+12. Early cloud tracking showed that the cloud was moving in four segments. Below 20,000 feet (6.1 km), cloud remnants were moving west-northwesterly. From 20,000 to 40,000 feet (6.1 to 12.2 km), cloud motion was northeasterly, from 40,000 to 80,000 feet (12.2 to 24.4 km) northwesterly, and above 80,000 feet (24.4 km) westerly, all at about 16 knots (20.6 km/hr) (Reference C.0.2-S).

The east cloud tracker was sent in the early afternoon of the day following MIKE. It searched northwest of Enewetak making a fan-shaped search pattern centered about 150 nmi (178 km) from Enewetak and looking from west-northwest to just east of north at ranges to 450 nmi (834 km) from the center point. This search, at an altitude of 10,000 to 15,000 feet (3.1 to 4.6 km), detected

intensities of from 0.005 to 0.01 R/hr outside the plane. These readings were higher than those of the cloud trackers of the previous day and were apparently one of the few solid contacts made with the late cloud.

Because of the lack of fallout-collection sites, the information necessary to construct a comprehensive map of MIKE fallout is not available. A segment of the close-in pattern over Enewetak Lagoon, however, has been inferred from Project 5.4a and has been plotted on Figure 23. Information developed by the AEC Worldwide Fallout Program pertinent to MIKE cloud travel included the notation of 0.001 R/hr on the ground at Guam on D+3, aerial monitoring showing 0.0015 R/hr at Agrihan in the northern Marianas on D+3, and elevated activity counts at Iwo Jima on D+4 (Reference D.4). This information along with the early visual observations and the D+1 cloud-tracker information confirms the suggestion that although details of the deposition are not known, the cloud travel and resultant down-pattern was northwest of Enewetak over the open ocean. Some fragment of the cloud over 80,000 feet (24.4 km) apparently moved east, however, and particles settled from the cloud into the lower layers of the atmosphere where the wind direction was from the east; these particles were deposited in the general test area (Reference C.1.3.615). The process took several days, by which time the radioactivity of these particles had decayed considerably.

This low-intensity, secondary fallout arrived first at the eastern islands about 2 days after the shot and moved to the western islands, most of which were affected after about 5 days. None of the stations observing this fallout recorded a rate exceeding 0.010 R/hr; in many instances the fallout could only be measured with laboratory-type instrumentation (Reference C.1.3.615, p. 48). At Kusaie, Ujelang, Bikini, Majuro and Kwajalein islands, the intensity was never as high as 0.0005 R/hr, as their automatic air samplers were never triggered (Reference D.4). The possible contribution of this secondary fallout to the exposure of task force personnel is discussed in Chapter 10.

Table 24 summarizes a number of these collections of secondary fallout. Table values are readings taken from samples of material collected on gummed paper and units recorded are in counts per minute (CPM) and not in the exposure rates of roentgens per hour used in this report. Some of these ships

Table 24. Secondary fallout on gummed paper collectors, IVY, MIKE.

Station and Location With Respect to MIKE	Sample Collection Period ^a	Counts per Minute (thousands)
Johnston Island 1,510 nmi (2,800 km) east-northeast	D+4 to D+5	1.5
Majuro 620 nmi (1,150 km) east-southeast	D+2	11
Kwajalein 375 (695 km) east-southeast	D+2	63
	D+3	210
	D+3 to D+5	19
	D+5 to D+6	3.5
Bikini 205 nmi (380 km) east	D+2	23
	D+3	8
USS O'Bannon (DDE-450) Approximately 110 nmi (200 km) east (from northeast to east)	D+2	81
	D+3	1,177
	D+3.5	183
	D+4	139
Kusaie 385 nmi (715 km) south and slightly east	D+3.5	3.2
	D+4 to D+5	11
USS Agawam (AOG-6) At Enewetak	D+2	44
	D+2.5	771
	D+3	25
	D+3.5	22
USS Estes (AGC-12) At Enewetak	D+2	2.7
	D+2.5	10
	D+3	925
	D+3.5	75
	D+4	21

(continued)

Table 24. Secondary fallout on gummed paper collectors, IVY, MIKE (continued).

Station and Location With Respect to MIKE	Sample Collection Period ^a	Counts per Minute (thousands)
<u>USS Oak Hill (LSD-7)</u> At Enewetak	D+2	81
	D+2.5	1,177
	D+3	182
	D+3.5	138
<u>USS Rendova (CVE-114)</u> At Enewetak	D+2	81
	D+3 to D+4	847
	D+4	23
	D+4.5	10
	D+5	2
	D+5.5	8
<u>USS Radford (DDE-446)</u> Off Enewetak	D+1	3
	D+1.5	10
	D+2	114
	D+2.5	992
	D+3	45
	D+3.5	58
Ponape 400 nmi (740 km) southwest	D+4 to D+5	15
	D+5 to D+6	14
	D+6 to D+7	4
	D+7 to D+8	2

Note:

^aCollection period usually 12 hours.

Source: Reference C.1.3.615, Table B.4.

also were taking intensity measurements during the same periods. For example, ship readings of 2,700 to 925,000 CPM relate to exposure rates from 0.004 to 0.008 R/hr.

USS Radford and USS Carpenter reported radioactive fallout while at sea off Enewetak Atoll between midnight and 1200 on 3 November. The fallout was most apparent during and immediately after rainsqualls and averaged 0.001 R/hr, with an occasional maximum approaching 0.003 to 0.004 R/hr (Reference C.3.1).

Regulations required ships to have a radiation level below 0.0006 R/hr for final radiological clearance, and on 5 November the TG 132.3 radsafe staff checked all ships and pointed out areas needing further decontamination. By 8 November all ships had radiation readings below the required level.

The night of 3 November, CJTF 132 sent a final radsafe advisory to the Commander in Chief Pacific (CINCPAC) stating that fallout from MIKE posed no health hazard to surface or air routes in the Pacific area. He also set 1130 on 13 November as the tentative time for the KING detonation. The next day the task force command post was transferred from Estes back to Parry Island.

KING SHOT

Preparations

KING was a stockpile weapon modified to produce a large yield. It was transported to Kwajalein by air from Kirtland AFB on 4 November and moved aboard Curtiss to prepare it for detonation. Curtiss had moved down from Enewetak following MIKE and served as the workshop for the KING weapon at Kwajalein as it had for MIKE at Eluklab.

The shot site on the reef north of Runit and the scientific stations on the island had to be prepared for KING. No permanent camp was reestablished on Runit following MIKE, so workcrews were dispatched daily from Parry (Reference C.0.1, p. 289). Each party was accompanied by a radiation monitor to advise the working party chief. Since most of the heavy work had been done before MIKE, only the final steps remained. Working parties could spend only limited time on the islands north of Runit because of radioactivity from MIKE.

Postponement

Thermal measurements were considered the most important of the KING measurements (Reference C.1.2, Jan Inst). A clear atmospheric path from the burst point to the ground-based instruments on Runit was therefore desirable, especially below 2,000 feet (610 meters). With the typical tropical air, this requirement caused several postponements.

Because preparations were well advanced and weather trends looked favorable, CJTF 132 on 9 November reported to the Department of the Army and the

Atomic Energy Commission (AEC) that the detonation schedule for KING remained 1130 on 13 November, as tentatively planned shortly after MIKE.

Weather conditions started to deteriorate, but preparations for the test on 13 November continued. Timing runs were finished and the northern islands evacuated. At 0200 on 13 November, the weather was marginal, but satisfactory conditions were anticipated by 1130. Kwajalein and Enewetak airfields were closed to all transient traffic, and most task force ships put to sea. By 1100 the task force was ready, with the drop aircraft in position, but the clouds were so thick that the test had to be postponed. Late on 13 November, a new shot day of 15 November was set. Although winds were favorable as D-day approached, local cloudiness and bad weather at Kwajalein forced another postponement, with 16 November projected as the next attempt.

KING Detonation

A review of weather conditions, apparently later on 15 November, revealed excellent wind conditions in prospect for the next day. The most radioactive portion of the shot cloud was not expected to rise above 35,000 feet (10.7 km), and strong easterly winds were predicted at that level and below. Such winds would minimize the risk of fallout on the main camps on Parry and Enewetak islands, which were roughly south of surface zero, the reef north of Runit. Consequently it was decided to press ahead with the test at 1130 on 16 November (Reference C.O.1, p. 290).

In preparation for KING, ships of TG 132.3 departed Enewetak Lagoon as follows:

<u>Vessel</u>	<u>Time of Departure</u>	<u>Date</u>
<u>USS O'Bannon</u>	1800	15 November
<u>USS Oak Hill</u>	0500	16 November
<u>USNS General E.T. Collins</u>	0800	16 November
<u>USS Agawam</u>	0810	16 November
<u>USS Lipan</u>	0815	16 November
<u>USS Rendova</u>	0820	16 November
<u>USS Carpenter</u>	0845	16 November
<u>USS Fletcher</u>	0845	16 November

Estes remained in the lagoon for the KING shot. Released from the control of TG 132.3, USS Elder, USS Arikara, and USS Yuma had sailed from the proving ground on 8 November, before KING. During KING, Curtiss and Leo were at Kwajalein, and LST-836 was at Bikini to evacuate personnel there if fallout occurred. MV Spencer C. Baird was at Bikini because of its role in Project 11.4. Locations of task force ships in the area of Enewetak and Bikini atolls, radex areas, and project instrumentation locations are shown in Figure 25. O'Bannon was positioned far to the southeast of Enewetak Atoll as air control ship to help to guide aircraft between Enewetak and Kwajalein.

The northern islands, except Runit, had been evacuated the afternoon before shot day. Runit itself was cleared by 1830 except for two H&N men who remained

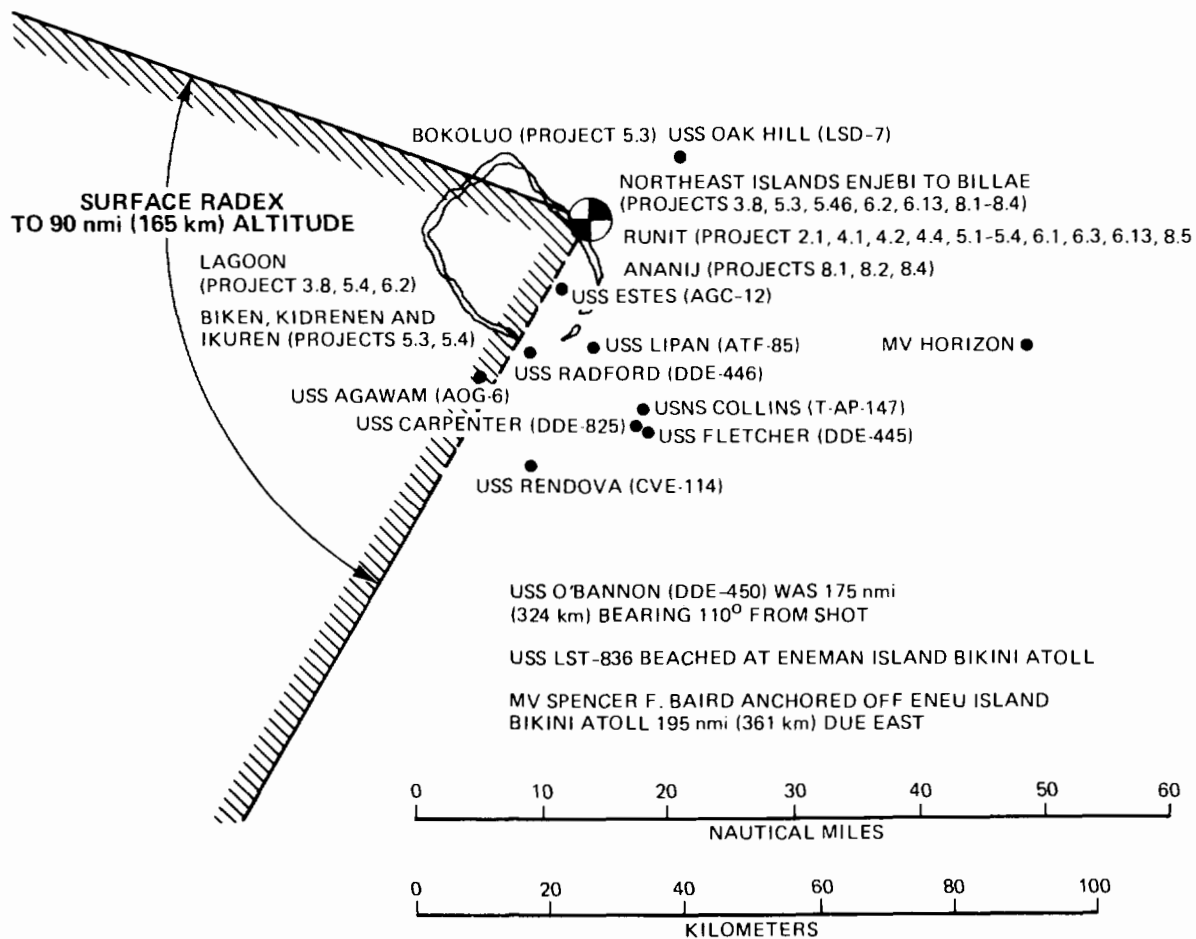

Figure 25. Radex areas, project instrumentation locations, and positions of task force ships, IVY, KING.

by helicopter began at 0700 on shot day. This helicopter stopped at Runit at about 0800 and picked up the two men at the powerhouse.

Because evacuation of Enewetak Island was not required, TG 132.2 preparations for KING were relatively simple. A special safety bulletin was issued that specified personnel safety measures. They were simple and consisted primarily of placing heavy objects that might be dislodged from shelves on the floor. Warning signals indicating the need for emergency evacuation if fallout occurred were also described. A system of monitoring for fallout on Enewetak Island was established. On shot day, the signal communications system was manned, and a public-address system was operating, over which all personnel could hear the progress of the test. All personnel working in hangars or buildings in which there could be a possible hazard from falling objects were ordered into the open as shot time approached. By 1115 the task group was ready (Reference C.2.3, Ninth Installment, pp. 1-3).

A party of official observers witnessed KING. On shot day, they assembled at the Officers Beach Club on Enewetak to observe the detonation. At about 1400, they departed Enewetak by air (Reference C.23, Ninth Installment, pp. 2-3).

As part of the final preparations, TG 132.4 began to dispatch its aircraft from Kwajalein to have them in position at detonation hour. Aircraft were deployed in four areas: the target area; the orbiting area, 50 nmi (93 km) southeast of surface zero; the refueling area over O'Bannon at $10^{\circ}30'N$, $165^{\circ}E$; and the Kwajalein area. WB-29 No. 1, responsible for monitoring shower activity before the detonation, was first to leave the target area and return to Kwajalein (Reference C.0.1, p. 291).

At shot time, the following aircraft were in the target area: the drop B-36H, the effects B-36 and B-47, two instrumentation B-50s (Nos. 1 and 2), two canister-drop B-29s, and three photo C-54s (Nos. 2, 3, and 4). Each of these aircraft had a closely prescribed flight path to assure its correct position. Figure 26 shows these paths and positions.

PARTICIPATING AIRCRAFT

CANISTER DROP B-29s - TWO 17.8 nmi (33.7 km) FROM GROUND ZERO AT 30,000 feet (9.15 km) ALTITUDE

INSTRUMENTATION B-50 - 56,400 (17.2 km) SLANT RANGE FROM GROUND ZERO, 20,000 feet (6.2 km) ALTITUDE, 2 nmi (3.7 km) AHEAD OF DROP AIRCRAFT

EFFECTS B-47 - 9,800 feet (3 km) HORIZONTAL RANGE FROM GROUND ZERO, HEADING 70°, ALTITUDE 35,000 feet (10.7 km). NO CHANGE IN HEADING FOR DETONATION

DROP B-36 - 40,000 feet (12.2 km) ALTITUDE TURNS TO 140° IMMEDIATELY AFTER BOMB RELEASE

EFFECTS B-36 - 35,000 feet (10.7 km) HORIZONTAL RANGE FROM GROUND ZERO AT 32,000 feet (9.7 km) ALTITUDE

PHOTO C-54's - THREE AT 15 nmi (27.8 km) AT ALTITUDES FROM 10-14,000 feet (3-4.3 km)

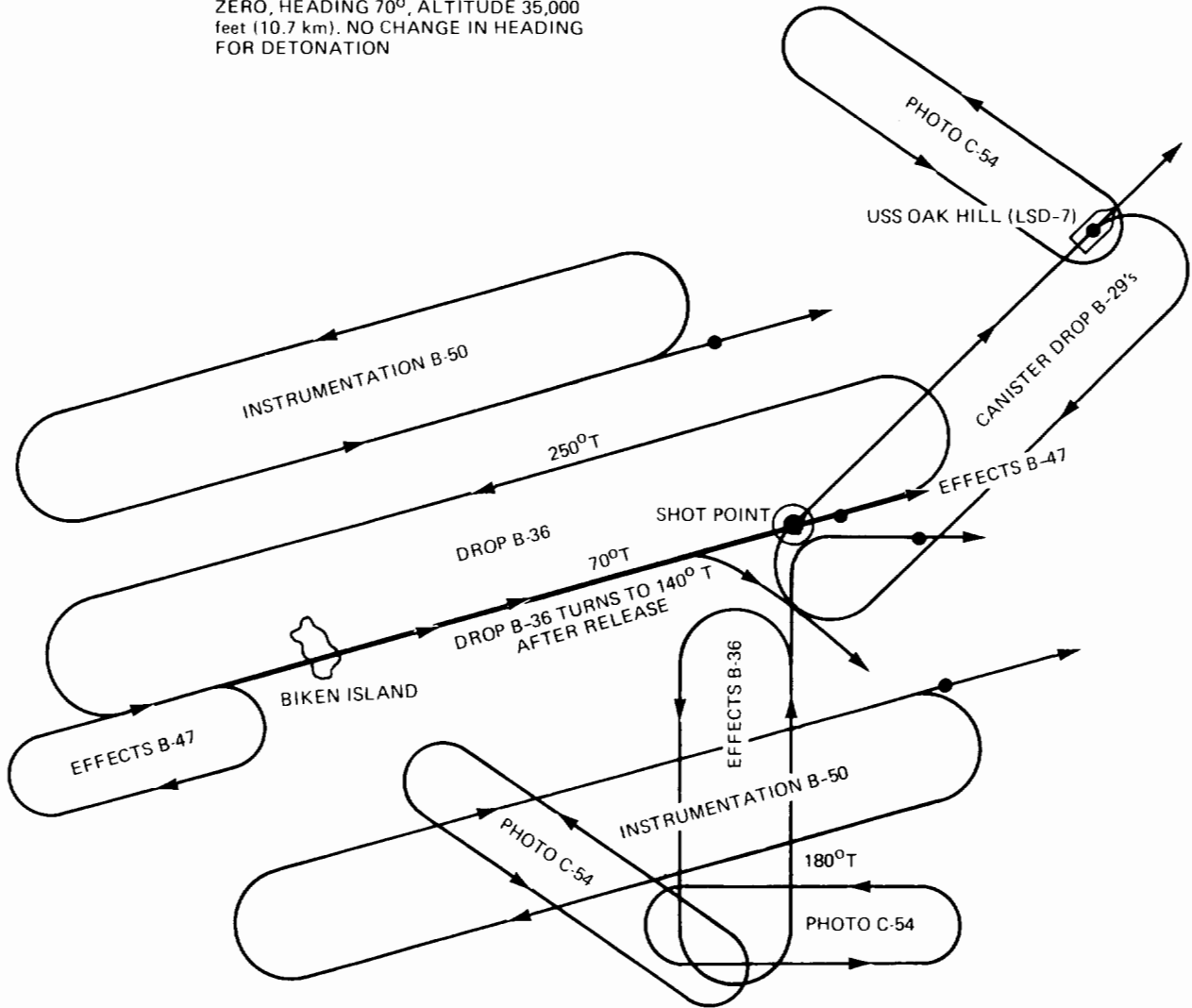

Figure 26. Aircraft positions and paths for IVY, KING.

Aircraft with missions in the vicinity of the KING cloud immediately following the detonation were in the orbiting area. These were the sampler control B-36, two NAVAID B-29s, two KB-29 tankers, two F-84G sniffers, and one SAR SA-16. Over O'Bannon in the intermediate refueling area were two KB-29 tankers, and one SAR SA-16. In addition, one photo RB-50 was 25 nmi (46 km) southeast of surface zero, and one photo C-47 was about 20 nmi (37 km) south of surface zero. The rest of the participating aircraft were still on the ground at Kwajalein or on their way to their assigned positions (Reference C.0.1, p. 291).

The KING weapon was successfully dropped at 1130. It detonated at about 1,480 feet (451 meters) above sea level over the target area 2,000 feet (610 meters) north of Runit Island. The JTF 132 Historian (Reference C.0.1, p. 294.) described the KING detonation:

KING Shot was perhaps more spectacular in many respects than MIKE Shot -- due, primarily, to the relatively close distance (approximately eleven miles) of observers to ground zero. The heat wave was immediately felt by observers and the growth of the fireball, the development of the cloud-chamber effect, and the formation of the conventional mushroom-shaped cloud were all clearly visible. In approximately forty-five seconds after detonation, the shock wave hit Parry Island and the sound was very similar to that experienced when in close proximity to the firing of a 90mm gun. The cloud rose rapidly to a great height, spread out over Parry Island and seemed to remain suspended there until it began to disperse. An early report estimated the cloud height to be approximately 67,000 feet with the base of the mushroom at 40,000 feet.

K-Day had begun as an almost cloudless day with a few low, fair-weather cumulus clouds; by midday, however, and as the KING cloud began to spread out radially in long streaks to the west, to the southeast, and to the southwest near and above the tropopause, the atmosphere had changed to a high, thin overcast. Small convective showers were clearly evident for a period of about two hours until once again trade conditions reestablished themselves.

The KING cloud as seen from Japtan is shown in Figure 27.

Damage from KING was noted as far north of surface zero as Lojwa, where brush was scorched, and as far south as Jinedrol, where brush was burning.

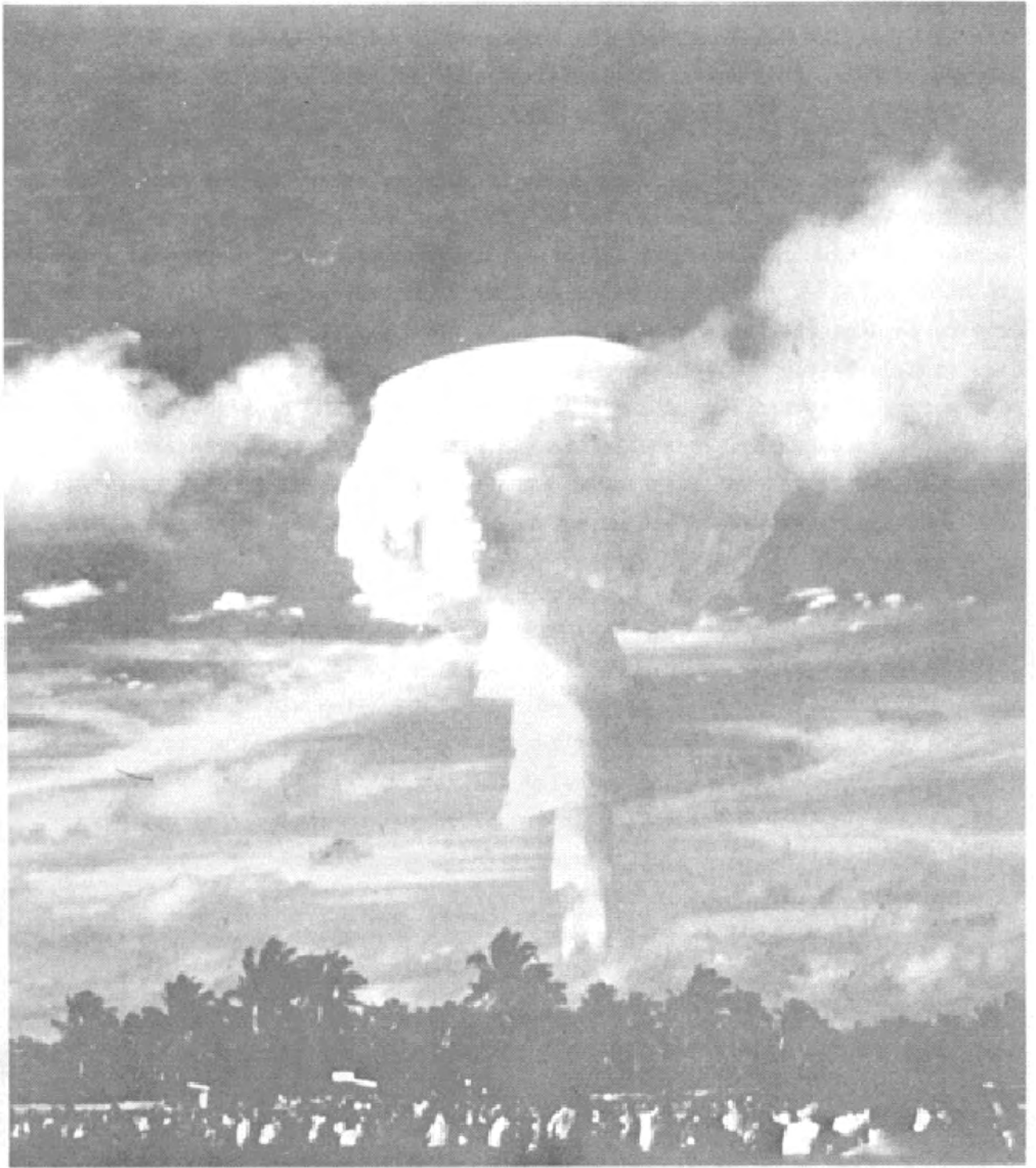

Figure 27. IVY, KING cloud viewed from Japtan.

Closer in at Billae, palms were broken and burned. Much debris from surface objects was on Runit itself with power poles downed and burning and puddles of water were standing a quarter of a mile (400 meters) from the water's edge. The airblast over the reef off the northern tip of the island had apparently pushed seawater that far onto the island (Reference C.1.2, KING Inst).

Reentry

Helicopters departed Rendova about 10 minutes after the detonation and arrived on Parry about 8 minutes later. At least one of them departed for a survey of Runit and the other islands about 30 minutes after the shot. About 20 minutes later, this party reported little contamination on Runit, and recovery parties then went about their tasks on schedule. Seventy minutes after the shot, a fairly comprehensive report on the condition of Runit was made. The survey party had recorded a reading of 0.3 R/hr 500 feet (152 meters) above the target area. Water in the vicinity of the target area showed no contamination. Contamination at the Runit powerhouse was 0.003 R/hr. Most of the recovery tasks were finished by the day after the test (Reference C.0.1, p. 300; Reference C.1.7.1, pp. 102-104).

Table 25 summarizes the activity of TG 132.4 aircraft during KING. Following the detonation, the sampler control B-36 positioned itself at 40,000 feet (12.19 km) downwind of the cloud. In cooperation with the two NAVAID B-29s, the B-36 guided the two sniffer F-84Gs into the cloud at 30,000 feet (9.14 km). The sniffers then refueled and returned to Kwajalein. The plan was to use twelve F-84Gs working in groups of two to gather samples. The first group was to leave Kwajalein at 1210 for arrival in the target area at 1300. The last group was to leave Kwajalein at 1430 to arrive on target at 1530. They were to be supported by a total of ten KB-29 tankers (Reference C.0.1, p. 298). Three of the sampler aircraft returned to Kwajalein before collecting samples. Sampling took place at an altitude of 44,000 feet (13.41 km); all sampler pilots had exposures of less than 3 R (Reference C.1.2, KING Inst).

The KING airburst produced little fallout and island contamination. None of the task force ships, which had reentered the lagoon by H+5, encountered fallout, although on the following day Rendova observed "a slight fallout of

Table 25. Mission aircraft participating in IVY, KING.^a

Aircraft	Altitude in kft (km) ^a	Range in kft (km) ^a	Mission
B-36	32 (9.75)	35 (10.7)	Effects
B-47	35 (10.67)	9.8 (3.0)	Effects
B-29 (2)	30 (9.14)	108 (32.9)	Canister drop
C-54 #2	10 (3.05)	91 (27.7)	Technical and documentary photo
C-54 #3	14 (4.27)	91 (27.7)	Technical and documentary photo
C-43 #4	12 (3.66)	91 (27.7)	Technical and documentary photo
B-36H	40 (12.19)	27 (8.23)	Weapon drop
B-29 #1	20 (6.10)	---	Sampler navigational control
B-29 #2	17 (5.18)	---	Sampler navigational control
B-36	40 (12.19)	---	Sampler navigational control
KB-29P (10)	15.5 (4.72)	---	Tankers
WB-29 #1	1.5 (0.47)	152 (46.3)	Shower monitor
WB-29 #2	18 (5.49)	---	Sampler
WB-29 #3	21 (6.40)	---	Sampler
WB-29 #4	10.5 (3.20)	---	Monitor local weather
WB-29 #5	15 (4.57)	---	Sampler
WB-29 #6	15 (4.57)	---	Sampler
WB-29 #7	15 (4.57)	---	Sampler
WB-29 #8	---	---	Sampler
SA-16 (2)	10 (3.05)	---	Search and rescue
SB-29 ^b	12 (3.66)	---	Search and rescue
H-19	---	---	Search and rescue
C-47	10 (3.05)	120 (36.6)	Technical and documentary photo
RB-50 ^c	13 (3.96)	152 (46.3)	Cloud photo
B-50 #1	20 (6.10)	56.4 (17.2)	IBDA ^d and transition telemetry time
B-50 #2	20 (6.10)	56.4 (17.2)	IBDA and transition telemetry time
F-84G (2)	---	---	Sniffers
F-84 ^e (12)	---	---	Samplers

Notes:

^aLocations shown are at detonation time. Ranges not shown are unknown; however, because of their missions, these aircraft should not have been close enough to the detonation to receive any initial radiation.

^bTwo SB-29s took off; however, one aborted with a propeller malfunction.

^cOperating altitude was supposed to be 22,000 feet (6.71 km); however, engine trouble forced the RB-50 to operate at 13,000 feet (3.96 km).

^dIndirect Bomb Damage Assessment.

^eTwo additional samplers took off; however, one aborted and, since samplers had to operate in pairs to collect samples, both returned to Kwajalein.

Sources: Reference B.4.5, pp. B-1 through W-1; Reference C.4.4, pp. 3-5.

beta radiation with isolated maximum intensity of 6 mr/hr" (Reference C.3.11). One B-36 showed contamination of 0.25 R/hr, and three F-84Gs showed between 0 and 1 R/hr. Residual contamination from MIKE obscured any contamination from KING on the northern islands of Enewetak Atoll. From Bokenelab southeast to Japtan an increase in radiation was detected. The islands in the southwest portion of the atoll also showed an increase. These increases may have been associated with the secondary fallout noted by Rendova. The possible contribution of this secondary fallout to exposures of task force personnel is discussed in Chapter 10. By 5 days after KING, contamination on Runit had decreased to a negligible amount. No material increase in radioactivity was detected in the lagoon or other locations (Reference C.1.7.1, p. 65).

The worldwide fallout network aerial surveys based at Guam recorded low-level radioactivity in the Marianas with a peak of 0.0005 R/hr at Agrihan 5 days after KING, but this may have been material from MIKE. Kwajalein-based survey flights noted 0.0003 R/hr at Ujelang and 0.0001 R/hr at several Marshall Island locations 1 day following KING (Reference D.4).

CHAPTER 5

SUMMARY OF U.S. ARMY PARTICIPATION IN IVY

Over 1,300 men from U.S. Army organizations participated in IVY. The primary function of the Army units involved was garrisoning Enewetak Island. Army units had been at Enewetak since the first nuclear tests there in 1948 (Operation SANDSTONE). When tests were not being conducted, these units remained and provided a continuing military presence. The commander of the major Army unit at Enewetak was Commander Task Group (CTG) 132.2. He acted as Atoll Commander for Commander Joint Task Force 132 (CJTF 132), who was an Army officer.

Army units also provided long-distance communications facilities and military police for the task force. Various Army laboratories conducted experiments during IVY, and Army personnel were among those in Task Unit (TU) 132.1.7, which provided radiological safety (radsafe) services for Task Group (TG) 132.1 and for the whole task force.

This chapter discusses the Army units represented at IVY in order of task force affiliation. Table 26 summarizes exposure information available from film badge readings. These film badges were issued to personnel whose activities were expected to place them in areas of radioactivity. Such activities for Army personnel included participation in experimental programs, acting as radsafe monitors, and providing security in contaminated areas.

The exposures do not include those due to the presence of a small elevation in the radioactive background that followed a very-low-level secondary fallout from MIKE and KING. Recent work suggests that a man who remained at Enewetak until the end of the year 1952, neglecting the shielding provided by buildings and the removal of contaminants by rain and wind, would be exposed to between 0.36 and 0.53 R (Reference D.4). This upper-bound estimate could possibly have been approached by permanent party Army personnel in TG 132.2, but, of course, scientific personnel and personnel for TG 132.2 augmentation units were withdrawn from the Pacific Proving Ground (PPG) soon after the tests.

Table 26. IVY personnel exposures, U.S. Army organizations.

	No. of Persons Badged	Exposure Ranges (roentgens)							
		0	0.001-0.5	0.5-1	1-1.5	1.5-2	2-2.5	2.5-3	Over 3
TG 132.1									
"TG 132.1"	6	4	1	1					
ACC (Civilian)	3		1				1		1 ^a
ACC (Army)	15		2	2	2	3	1	5	
Office of Chief, ACC	1					1			
ESL (Civilian)	4	2	2						
ESL (Army)	1		1						
Ft. McClellan	1						1		
Ft. Sill	1							1	
971st OTSU	1							1	
8452nd AAU	1				1				
Non-Army Org	15		8	6		1			
Total Army 132.1	49	6	15	9	3	5	3	7	1
TG 132.2									
"TG 132.2"	46	24	21					1	
4th Trans Truck Co	1				1				
18th MP CID	1	1							
511th Trans Port Co	11		4	1	1	3	1	1	
516th MP	34	5	29						
7126th AU	8		7	1					
7131st AU, Sig Det	5			5					
Total Army 132.2	106	30	61	7	2	3	1	2	
Other Army	9	3	6						
Total Army JTF 132	164	39	82	16	5	8	4	9	1

Notes:

^aBadge reading was 3.3 R, the highest U.S. Army reading.

Source: Reference C.1.7.2.

HEADQUARTERS JOINT TASK FORCE 132

The IVY history indicates that two Army officers and nineteen enlisted men served in the Headquarters component (Reference C.0.1, p. 81). These men are not further identified, so exposure information for the Headquarters group cannot be extracted from the Consolidated List (Reference C.1.7.2), although three are cited as "JTF 132." Whether this refers to the Headquarters is not clear, so exposures for these men have been relegated to the "Other" category in Table 26.

TASK GROUP 132.1 (SCIENTIFIC)

Total Army personnel in this task group is given as 105 in a JTF 132 report, Personnel and Administration (Reference C.1.3.636). The history indicates that 30 of these men served in Hq TG 132.1 (Reference C.0.1, p. 81), and the rest served in the task units and projects making up TG 132.1. Identifiable Army personnel participation was in Task Unit (TU) 132.1.1, Projects 2.1, 5.4b, 6.1, and 9.2; TU 132.1.7 (Radsafe); and TU 132.1.9 (Photography). Six men were identified simply as "TG 132.1" in the Consolidated List and have been entered thus in Table 26. Remaining Army personnel identified in this group are discussed below under their home organizations and their exposures are listed this way in Table 26.

Army Chemical Center (ACC), Chemical and Radiological Laboratories, Edgewood Arsenal, Maryland. Twelve men (three civilians, two Air Force officers, and seven Army enlisted men) are cited in the Project 5.4b report as participating in Enewetak field operations. Eleven appear on the Consolidated List with exposures. In addition, eight Army personnel from this organization serving in TU 132.1.7 were badged. These men were used as radsafe monitors and in personnel decontamination operations. Their exposures are given in Table 26.

Army Chemical Corps, Office of the Chief, Washington, D.C.. One officer from this office served as a radsafe engineer in TU 132.1.7 and was badged.

Evans Signal Laboratory (ESL), Ft. Monmouth, New Jersey. Two civilians who were badged as part of Project 9.2 may have been remotely located at Bikini during the test period. Their badges showed no exposure. Two other

civilians and one soldier from this organization served in the laboratories of TU 132.1.7. Exposures for identified ESL personnel are shown in Table 26.

Ft. McClellan, Alabama. One officer from the Army Chemical Corps School was in TU 132.1.7.

Ft. Sill, Oklahoma. One soldier from the Artillery School at Ft. Sill was badged and received an exposure of 2.5l R. He was possibly with TU 132.1.7.

971st OTSU, Ft. Monmouth, New Jersey. One soldier from this organization was in TU 132.1.7.

8452nd AAU, Sandia Base, New Mexico. One soldier from the Special Weapons School was in TU 132.1.7.

Non-Army Organizations. In addition, Army personnel with non-Army duty stations participated. These included Naval Research Laboratory (2 men), Air Force 1523rd Motion Picture Squadron (2 men), and Los Alamos Scientific Laboratory (11 men). Exposures for these men are entered under non-Army organizations in Table 26.

TASK GROUP 132.2 (ARMY)

This Army support task group was composed of several garrison units at Enewetak and several other units that augmented the garrison forces.

Forty-six Army personnel were identified only as "TG 132.2" in the Consolidated List. Exposures of these men are presented first in Table 26, followed by the exposures of men who can be associated with the several TG 132.2 units.

4th Transportation Truck Company. Three officers and one hundred twenty-five enlisted men were stationed at Enewetak through IVY. Only one individual was badged. See Table 26.

18th Military Police Criminal Investigation Division. One man was badged.

125th Military Police Provost Marshal Detachment. Two officers and five enlisted men were on Enewetak, none of whom was badged.

511th Transportation Port Company. Five officers and one hundred fifty-five enlisted men were exclusively on Enewetak. Eleven were badged and may have been used as radsafe monitors, as exposures are higher than normal duties would imply. See Table 26.

516th Military Police Service Company. Six officers and one hundred sixty-one enlisted men were stationed about equally among Enewetak, Parry, and (before the MIKE shot) in the northern islands of the atoll. Only 34 of these were apparently badged; their exposures are listed in Table 26.

7126th Army Unit. This unit was one of the garrison units at Enewetak between GREENHOUSE and IVY. Forty-four officers and four hundred sixty-six enlisted men on Enewetak acted as the Headquarters TG 132.2 element. Eight were badged. See Table 26.

7131st Army Unit, Signal Detachment. This unit was one of the organizations that augmented TG 132.2 for IVY. Six officers and ninety-four enlisted men equally divided between Enewetak and Parry arrived in April and May of 1952 for communication duties. Only five were badged. See Table 26.

Communications Security Detachment No. 1, 8607th AAU. Four officers and thirty-one men arrived in the PPG in August 1952, where they served as communications monitors on Enewetak and aboard USS Estes in Enewetak Lagoon from 24 September to 18 November 1952. None was badged.

Sub-Detachment C, Provisional Counterintelligence Corps. One officer and seven enlisted men from this group arrived in June 1952 and served on Enewetak, Parry, and in the northern islands. Apparently none was badged.

U.S. Army Pacific (USARPAC). Three officers and ninety-five enlisted men from Hawaii were sent to Enewetak Island for temporary duty in September and October 1952. They were stevedores, electricians, carpenters, and mechanics. They were out of the PPG by 27 October 1952. None was badged.

Other Identifications. Nine Army personnel in the Consolidated List are identified only as "132" or "TG 132" or some other incomplete designation. Their exposures are listed under "Other Army" in Table 26.

CHAPTER 6

SUMMARY OF U.S. NAVY PARTICIPATION IN IVY

Navy participation in IVY involved over 5,300 men. The primary roles of the Navy were to provide ships to evacuate all task force personnel from Eniwetok for MIKE, provide surveillance of the test area by air and sea, and provide logistic support. Naval laboratory and small boat units made important contributions to the program. Distribution of naval personnel in the task force is presented in Table 27.

Naval organizations and individuals participated in IVY in Headquarters Joint Task Force 132 (Hq JTF 132), and in Task Group (TG) 132.1 (Scientific), TG 132.2 (Army), and TG 132.3 (Navy) during IVY, and as units that had missions that took them to or near the Pacific Proving Ground (PPG) during IVY. Although most of the naval personnel were in TG 132.3, 12 officers and 12 enlisted men were in Hq JTF 132; 5 officers and 6 enlisted men were in Hq TG 132.1 (Reference C.0.11, p. 8); and 1 officer and 25 enlisted men were in TG 132.2. TG 132.3 supported the scientific programs directly, both as instrumentation platforms and in data recovery operations, and indirectly by providing afloat headquarters and evacuation and sealift capability.

This chapter lists the naval organizations given as the affiliation for personnel appearing in the Consolidated List of Radiological Exposures (Reference C.1.7.2). It also gives the number of uniformed or civilian persons listed with each organization, and the functions of the organizations in the IVY operation. These numbers are based on various after-action reports and the Consolidated List and may not coincide exactly with Table 27. Table 28 summarizes all Navy Consolidated List personnel exposures for each organization.

HEADQUARTERS JOINT TASK FORCE 132

Naval personnel serving in the JTF 132 Headquarters are not readily identifiable as such from the Consolidated List and therefore do not appear in Table 28.

Table 27. Naval personnel in IVY.

	Planned ^a	Actual ^b
Headquarters and Staff CJTF 132	---	91
Headquarters and Elements, TG 132.1	---	59
Headquarters and Staff, TG 132.3	62	65
Weapons Element		
<u>USS Curtiss (AV-4)</u>	641	667
Transport Element		
<u>USNS General E.T. Collins (T-AP-180)</u>	26 ^c	17 ^c
<u>USS Estes (AGC-12)</u>	554	587
<u>USS Leo (AKA-60)</u>	231	242
<u>USS LST-836</u>	128	---
<u>USNS David C. Shanks (T-AP-80)</u>	26 ^c	25 ^c
Service and Harbor Control Element		
<u>USS Oak Hill (LSD-7)</u>	333	433
Boat Pool	140	145
LCU-666	---	13
LCU-667	---	7
LCU-709	---	11
LCU-764	---	12
LCU-851	---	2
"Total 5 LCU's"	61	---
Fueling Unit		
<u>USS Agawam (AOG-6)</u>	122	42
Barges	14	---
Enewetak Shore Detachment	---	18
Towing Unit		
<u>USS Lipan (ATF-85)</u>	74	83
<u>USS Yuma (ATF-94)</u>	74	79
<u>USS Arikara (ATF-98)</u>	74	79

(continued)

Table 27. Naval personnel in IVY (continued).

	Planned ^a	Actual ^b
Service and Harbor Control Element (continued)		
Underwater Detection Unit	21	19
Seismographic Unit		
<u>MV Spencer F. Baird</u>	0 ^c	21 ^c
<u>MV Horizon</u>	0 ^c	26 ^c
Special Mooring Element		
<u>USS Elder (AN-20)</u>	36	48
Destroyer Element		
Commander Destroyer Division 1	10	8
<u>USS Carpenter (DDE-825)</u>	278	288
<u>USS Fletcher (DDE-445)</u>	257	267
<u>USS O'Bannon (DDE-450)</u>	252	275
<u>USS Radford (DDE-446)</u>	259	272
Convoy and Escort Element		
Carrier Unit		
<u>USS Rendova (CVE-114)</u>	876	964
Marine Component Air Department	56	---
FASRON-7	---	5
HS-2	---	30
VC-3 Detachment	---	38
Patrol Plane Unit		
Patrol Squadron 2 (VP-2)	345	352
FASRON-110	47	---
Air Transport Units		
Transport Squadron 3 (VR-3)	---	18

Notes:

^aReference B.0.2 (Op Plan 2-52).^bData from Chief of Naval Operations, OP 981-TD, August 1982.^cCivilian crews not included.

Table 28. IVY personnel exposure, U.S. Navy organizations.

Organization	No. of Persons Badged	Exposure Ranges (roentgens)							Over 3	
		0	0.001-0.5	0.5-1	1-1.5	1.5-2	2-2.5	2.5-3		
TG 132.1 (Scientific)										
BuShips	2		1	1						
NAU (Sandia Base)	4	1	1				1		1 ^a	
NAS (Norfolk, VA)	1				1					
NEL	1		1							
NOL	3		2		1					
NRDL	10	2	4	1	2		1			
NRL	50	3	20	10	12	2	2	1		
Navy Dept. (Wash., D.C.)	1				1					
ONR (Pasadena Br.)	1			1						
13th Dist. (Seattle)	1				1					
Special Weapons Unit	2			1	1					
Staff CINCLANTFLT	1				1					
Staff COMNAVAIRPAC (San Diego, CA)	1						1			
Fleet Post Office (FPO) 824	5		3	2						
CINCPACFLT	1	1								
Total Navy 132.1	84	7	32	16	20	2	5	1	1	
TG 132.2 (Navy Det)	1		1							
TG 132.3 (Navy Staff)	30	1	29							
TE 132.30 (Weapons Element)										
<u>USS Curtiss (AV-4)</u>	20	20								
TE 132.31 (Transport Element)										
<u>USS Estes (AGC-12)</u>	97	4	92			1				
<u>USNS David C. Shanks (T-AP-180)</u>	8		8							
TE 132.32 (Service and Harbor Control Element)										
<u>USS Agawam (AOG-6)</u>	21	3	18							
<u>USS Arikara (ATF-98)</u>	14	14								
<u>USS Elder (AN-20)</u>	14	5	9							

(continued)

Table 28. IVY personnel exposure, U.S. Navy organizations (continued).

Organization	No. of Persons Badged	Exposure Ranges (roentgens)							
		0	0.001-0.5	0.5-1	1-1.5	1.5-2	2-2.5	2.5-3	Over 3
TE 132.32 (Service and Harbor Control Element) (continued)									
LCU-666	14		13			1			
LCU-667	6	6							
LCU-709	8	1	7						
LCU-764	8	8							
USS Lipan (ATF-85)	12		12						
USS Oak Hill (LSD-7)	101	16	83		1	1			
USS Yuma (ATF-94)	11	1	10						
TE 132.33 (Destroyer Element)									
USS Carpenter (DDE-825)	21		21						
USS Fletcher (DDE-445)	20		20						
TU 132.3.0 (Carrier Unit)									
USS Rendova (CVE-114)	199	137	61	1					
HS-2 (Navy)	33	14	10	2	2	1	4		
TU 132.3.1 (Patrol Plane Unit)									
VP-2 (Whidbey Is.) ^b	72	6	66						
Total Navy 132.3	710	236	460	3	3	4	4		
NON-JTF 132 NAVY UNITS									
VR-3 (Transport Sq.)	15	1	14						
VR-8 (Transport Sq.)	1		1						
Total Badged Navy JTF 132	810	244	507	19	23	6	9	1	1

Notes:

^aHigh was 3.09 R.

^bOne badge lost.

Source: Reference C.1.7.2.

TASK GROUP 132.1 (SCIENTIFIC)

Eighty uniformed Navy personnel and at least 101 employees of naval laboratories served in TG 132.1. Thirteen of the uniformed personnel were in staff functions in Hq TG 132.1 and the rest were primarily in Task Unit (TU) 132.1.1, although TU 132.1.7 (Radiological Safety) had a substantial Navy representation (Reference C.1.3.636). The descriptions of each organization's activity may be limited to a reference to a specific project. These projects are described as a group in Chapter 3, "DOD Experimental Program." Table 28 lists the exposures for naval personnel in TG 132.1 from the following organizations.

Bureau of Ships (BuShips), Washington, D.C. Two men from Buships were badged in IVY. An officer from BuShips, Code 348, participated in Project 5.4a. His exposure was 0.17 R. A civilian from Code 588 received 0.94 R, but his duties are not known. BuShips supervised the installation of washdown systems on the Navy ships.

Naval Administrative Unit (NAU), Sandia Base, New Mexico. This organization administered naval personnel who were on duty assignments at Los Alamos Scientific Laboratory (LASL) and the Armed Forces Special Weapons Project (AFSWP), Field Command. Three individuals appeared on the Consolidated List and two can be identified as participating in Project 6.1. A fourth man was badged as simply "TU-1;" presumably, LASL was his duty station and he was in one of the weapon units. His exposure of 3.09 R, the highest recorded by any naval personnel at IVY, is included in the NAU exposures in Table 28.

Naval Air Station, Norfolk, Virginia. One naval officer from this air station was badged and participated as a radiological safety (radsafe) engineer in TU 132.1.7; he was detailed to USS LST-827 for the Ujelang evacuation (Reference 1.7.5).

Naval Electronics Laboratory (NEL), San Diego, California. Three individuals participated in Projects 6.4b and 6.7c. One individual was badged and had an exposure of less than 0.5 R. He was on the MV Horizon.

Naval Ordnance Laboratory (NOL), White Oak Maryland. Six men are recorded as participating in Program 6 (Blast Measurements). Three individuals were badged with a high reading of 1.085 R.

Naval Radiological Defense Laboratory (NRDL), San Francisco, California. Ten individuals from NRDL were badged. Seven of these are identified as participating on Project 5.4a. The highest reading of this group was 2.355 R.

Naval Research Laboratory (NRL), Washington, D.C. NRL was the largest laboratory organization participating in IVY. Ninety-four people are recorded as participating in Program 2 and in Projects 5.4a, 6.4b, 6.7a, and 8.5. Only 50 people (8 Navy, 1 Air Force, 1 Army, and 40 civilians) were badged. The highest reading in this group was 2.755 R.

Navy Department, Washington, D.C. There was one visitor whose badge read 1.25 R.

Office of Naval Research (ONR), Washington, D.C. and Branch Office, Pasadena, California. Six people were scheduled to participate in Projects 11.2, 11.3, and TU 132.1.7. One officer from ONR, Pasadena, was aboard the Horizon during the MIKE shot period. His exposure was 0.620 R.

Public Works Officer, 13th Naval District, Seattle, Washington. One individual who worked as a radsafe engineer in TU 132.1.7 was badged. His exposure was 1.230 R.

USN Special Weapons Unit (SWU), Sandia Base. Two men participating with Project 5.4a were badged.

Staff CINCLANT, Naval Base, Norfolk, Virginia. One naval officer was badged with this unit. He served in TU 132.1.7 as a radsafe engineer, and his exposure was 1.320 R.

Staff ComNavAirPac, San Diego, California. One naval officer with this unit was badged. He participated as a radsafe engineer in TU 132.1.7 and in reentry operations on Project 2.1a with NRL. His exposure was 2.375 R.

Other Navy Elements.

Fleet Post Office (FPO) 824, San Francisco - USN. Five individuals (two Navy, three unknown) were badged with this FPO, which was at Kwajalein NAS. Highest badge reading was less than 1 R.

Pacific Fleet. One civilian had a zero reading. His organization was listed as "SIMPAC Fleet;" it is assumed that the meaning is actually Commander in Chief, Pacific Fleet (CINCPACFLT).

TASK GROUP 132.2 (ARMY)

Navy Detachment. This group, which remained at Enewetak between GREENHOUSE and IVY, provided small boat support for the garrison force at Enewetak. This detachment provided intra-atoll service for Enewetak in cooperation with the small boat service provided by the H&N boat pool. The detachment called for an operational strength of one officer and twenty-four enlisted men. The officer was badged.

TASK GROUP 132.3 (NAVY)

Personnel exposures from the Consolidated List are presented in Table 28 for the naval units of TG 132.3. Units were organized into elements whose functions are discussed in Chapter 1. Information in Table 28 is presented in order of these elements. Support activities for the scientific program by units are summarized in Table 29. The organizational elements are shown in Table 8. Thirty men were badged with the designation "TG 132.3 Staff."

Task Element 132.30 (Weapons Element)

The seaplane tender USS Curtiss had two roles during Operation IVY. As the Convoy and Escort Element (TU 132.34.0), Curtiss transported components of the MIKE device from the United States to Enewetak, arriving 12 September 1952. The destroyers USS Mansfield (DD-728) and USS Collett (DD-730) escorted Curtiss as far as Hawaii, where the escort destroyers USS Carpenter, USS Fletcher, USS O'Bannon, and USS Radford met and relieved the destroyers on 5 September. The escort destroyers screened Curtiss for the rest of the journey to Enewetak. At Enewetak, the Convoy and Escort Element was dissolved, with Curtiss becoming the Weapons Element (TE 132.30) and the escort destroyers becoming the Destroyer Element (TE 132.33). As the Weapons Element, Curtiss provided shop and other facilities to weapon assembly units (TU 132.1.4 and TU 132.1.5). It

Table 29. Task Group 132.3 ship and aircraft scientific project support, Operation IVY.

	Unit participation
Program 5 (Gamma-Ray Measurements)	
Project 5.4a Fallout Distribution	USS O'Bannon (DDE-450), one P2V-4, USS Rendova (CVE-114), USS Yuma (ATF-94), USS Arikara (ATF-98), laid and recovered dan buoys; and 10 ships mounted gummied paper for fallout collection: USS Curtiss (AV-4), USS Estes (AGC-12), USS Leo (AKA-60), USS Oak Hill (LSD-7), USS Agawam (AOG-6), USS Carpenter (DDE-825), USS Fletcher (DDE-445), USS Radford (DDE-446), O'Bannon, Rendova
Program 6 (Blast Measurements)	
Project 6.2 Air Mass Motion Studies	Curtiss sent six enlisted men to mount 10 antiaircraft guns before MIKE
Project 6.4b Sea Waves	USS Lipan (ATF-85), MV Horizon
Project 6.7a Underwater Pressure in Deep Water	Curtiss, Yuma, USS Elder (AN-20), one P2V (VP-2)
Project 6.11 Free Air Pressure as a Function of Time	Oak Hill
Program 7 (Long-Range Detection)	
Project 7.5 Transportation of Airborne Debris	Curtiss participated only on MIKE, Oak Hill participated only on KING; Estes, Rendova
Program 9 (Electromagnetic Phenomena)	
Project 9.2 Radio Wave Propagation Measurement	Rendova, two P2Vs (VP-2)
PROGRAM 11 (Preliminary Geophysical and Marine Survey of the Test Area)	
Project 11.4 Seismic Refraction Studies	Lipan, Horizon, MV Spencer F. Baird participated only after KING
Project 11.5 Marine Survey	Oak Hill, Task Group 132.3 boat pool
Atomic Energy Commission World-Wide Monitoring Program	Two PBM-5As (FASRON-110)
Source: Reference C.3.1.	

was anchored off Eluklab during the pre-MIKE assembly activities. Before MIKE, Curtiss evacuated personnel of CJTF 132, TG 132.1, and TG 132.2. Curtiss sortied from berth D-4 at Enewetak at 0359 on 1 November via Deep Entrance and at 0445 rendezvoused with Fletcher and Radford. The next day Curtiss reentered the lagoon and anchored in berth C-3, 18 nmi (33 km) southeast of the MIKE crater (Reference C.3.8, Curtiss).

Curtiss also participated as an instrumentation platform for Scientific Projects 6.2, 6.7a, and 7.5. Curtiss sent six gunners ashore before MIKE to assist in installing ten 3-inch/50-caliber guns for Project 6.2. The guns were fired by remote control just before detonation and their projectiles detonated in the air to create smoke puffs. Movement of the shock wave through the smoke puff pattern was analyzed using photographs. In Project 6.7a, Curtiss served without success as a telemetering center to measure the magnitude of the underwater shockwave pressure during shot MIKE. For Project 7.5, Curtiss-based photo-optical instruments measured the height of the mushroom cloud from MIKE. Curtiss crew also mounted gummed paper on the ship to collect fallout as part of Project 5.4a.

After participating in MIKE, Curtiss left Enewetak 2 November at 1535 for Kwajalein, escorted by Fletcher. It carried excess TG 132.1 personnel to Kwajalein and then provided facilities to support preparation of the KING weapon, which had been brought by air from the United States to Kwajalein. Curtiss remained at Kwajalein for KING on 16 November 1952. On 18 November Curtiss left Kwajalein, arriving at Port Chicago, California, on 30 November. It was released from operational control of TG 132.3 on 2 December. The ship received a final clearance following its participation in IVY testing. According to the data available, none of the ship's crew or Marine Corps security personnel assigned to Curtiss received a radiation exposure (Reference C.3.2, pp. 12-14). All 20 badges issued aboard Curtiss had zero readings.

Task Element 132.31 (Transport Element)

Five ships made up the Transport Element 132.31 of TG 132.3 during Operation IVY. USS Estes, an amphibious force flagship, served as command ship of the task element, except during shot operations when it was on independent duty. The ship had a temporary helicopter landing platform, installed before

deployment. It also carried additional communications equipment to support the activities of several organizations embarked during operations afloat: TG 132.1, TG 132.3, Task Force Weather Central, and the Air Force Senior Air Controller. During MIKE, the ship's crew conducted observations of the radioactive cloud for Project 7.5. The crew mounted gummed paper to collect fallout particles as part of Project 5.4a for both MIKE and KING. Ninety-seven personnel, who were issued badges aboard Estes, appear on the Consolidated List. The highest exposure recorded was 1.630 R; 92 badges showed exposures of 0.001 to 0.5 R; and 4 badges read zero.

USS LST-836, a tank landing ship, provided transportation between Enewetak and Bikini atolls for construction at Bikini. USNS General E.T. Collins, a troop transport operated by a civilian crew of the Military Sea Transportation Service (MSTS), served as an evacuation ship for task force personnel during MIKE and KING. USNS David C. Shanks, also a troop transport operated by an MSTS civilian crew, evacuated task force personnel during MIKE. USS Leo, an attack cargo ship, evacuated task force personnel and material during MIKE.

IVY planning limited the mission of the Transport Element to evacuating personnel and material from Enewetak for MIKE, and as an emergency evacuation force for KING. Additional requirements developed during the operational phase of IVY. First, LST-836 was detached to support construction work at Bikini Atoll for Operation CASTLE, which was scheduled for the following spring. Consequently, the LST was not present at Enewetak for either IVY shot and received no fallout. Second, Estes was to be employed as command and firing ship for MIKE, and therefore had special positioning requirements. To meet these requirements, it had to operate independently of the other ships of the Transport Element, thus removing it from tactical command of the task element. Leo's commanding officer was designated Commander TE 132.31 during MIKE.

Primary aircraft control during KING came from Estes. The ship took aboard the Senior Air Controller of the Air Force task group, but remained moored in Enewetak Lagoon off Parry Island to maintain secure communications with task force headquarters on Parry. Shanks and Leo had departed Enewetak on 11 November and 26 November, respectively (Reference C.3.1, p. 131). Collins, the only other ship of the Transport Element remaining at Enewetak, was incorporated

into a new organization, the Main Body. This new task element operated under the Commander Escort Destroyer Division 11. Summaries of the operational activities recorded in the Transport Element ships' deck logs follow.

● MIKE (0715, 1 November)

- USS Estes. Sortied from Enewetak at 0309 to position 37 nmi (69 km) south of shot. From 0840-1547 launched and landed helicopters. Moored to buoy in Berth B-1 at Enewetak at 1051 on 2 November, 18 nmi (33 km) from the MIKE crater.
- USS Leo. Sortied with six Atomic Energy Commission (AEC) civilians and twelve Army enlisted men as passengers at 1358 on 31 October, 37 nmi (69 km) south of detonation. In formation with Collins and Shanks on shot day. Anchored in anchorage C-2 at 1051 on 2 November, 18 nmi (33 km) from MIKE crater.
- USNS General E.T. Collins. Evacuated Army officers and Coast Guard personnel to 36 nmi (67 km) south of detonation. These were returned by helicopter at 1525 on 1 November. On 2 November anchored in anchorage K-2, 25 nmi (46 km) south of MIKE crater. At 1325 on 8 November the staff of CTG 132.3 surveyed the vessel with radiac equipment. No radiation was recorded below decks; the weather decks averaged 0.0015 to 0.0025 R/hr with a maximum of 0.006 R/hr (beta plus gamma). The deck crew washed down deck at 1700 to lower intensity.
- USNS David C. Shanks. Operated in sortie area Item 33.50, 39 nmi (72 km) south of shot, with 197 cabin-class and 456 troop-class passengers.
- USS LST-836. Anchored at Bikini.

● KING (1130, 16 November)

- USS Estes. Moored to buoy in berth B-1, Enewetak, 11 nmi (20 km) south of KING surface zero.
- USS Leo. Anchored at anchorage K-13, Kwajalein.
- USNS General E.T. Collins. At 0747 underway out of Enewetak Lagoon. Returned to Enewetak at 1735, anchored 13 nmi (24 km) south of KING surface zero.
- USNS David C. Shanks. Departed Enewetak before the shot (11 November).
- USS LST-836. Beached on the north side of Eneman Island in Bikini Lagoon. Rolled up weather stations following KING.

Estes left the PPG on 19 November. Leo left on 26 November with three Army officers and thirty-one enlisted men as passengers. Shanks left on 11 November and LST-836 on 21 November. Departure date of Collins was 20 November.

As the radiological exposure information in Table 28 indicates, data for ships of the Transport Element are incomplete. No men of LST-836, Collins, or Leo are mentioned in the Consolidated List. However, according to radsafe planning documents, LST-836 was assigned five badges and ten each were assigned to the other two ships.

Task Element 132.32 (Service and Harbor Control Element)

Six Navy ships, two civilian tugs, an Underwater Detection Unit of one officer and twenty enlisted men, and thirty-three yard and harbor craft made up the Service and Harbor Control Element (TE 132.32) for Operation IVY. It was the largest task element in TG 132.3. Brief descriptions of the Navy ships' operational activities for both shots follow, based on information from the ships' deck logs.

● MIKE (0730, 1 November)

- USS Oak Hill. Embarked 16 LCMs and 4 LCP(L)s at 1725 on 31 October. Embarked AVR-82 at 0149 on 1 November and at 0200 left Enewetak Lagoon for operating area, 32 nmi (59 km) southeast of MIKE site. Received helicopter after the shot (at 1448). From 1503 to 1840 debarked two LCMs and two AVRs. On 2 November re-entered the lagoon and moored to telephone buoy, berth N-3, 25 nmi (46 km) south of MIKE crater.
- USS Agawam. Underway from Enewetak Lagoon at 0916 on 31 October. Steamed with Yuma, Arikara, and Elder 33 nmi (61 km) southeast of surface zero during the shot. Returned on 2 November at 1130 and moored to petroleum, oil, and lubricants (POL) buoys F1 and F2, Enewetak Lagoon, 26 nmi (47 km) south of MIKE crater.
- USS Lipan. Underway from Enewetak Lagoon at 0903 on 31 October with AFDL-5 in tow. Ship located 25 nmi (46 km) east of surface zero at detonation time. Returned on 2 November with AFDL-5 at 1426.
- USS Arikara. On 31 October at 0905 underway to area F-30-50 with barges M-125, YC-1354, and YC-737 in tow. In formation with Agawam, Elder, and Yuma, 34 nmi (63 km) southeast of surface zero, during the shot. Returned at 1223 on 2 November with barges still in tow and anchored 25 nmi (46 km) south of MIKE crater. On 6 November recovered one buoy reading 0.08 R/hr located 155 nmi (287 km) northwest of Enewetak. Second buoy sunk with rifle fire.
- USS Yuma. Underway from Enewetak Lagoon at 1646 on 31 October for operating area F-30-50 with LCU-666, LCU-667, and LCU-709 in tow. During the detonation, steamed 36 nmi (67 km) southeast of shot site.

- USS Elder. Left Enewetak at 0835 on 31 October to lay instrument buoys. Joined other units of TE 132.32 at 0135. Ship located 34 nmi (65 km) southeast of shot site at time of detonation. At 0807 on 1 November tested washdown system. At 1134 on 2 November anchored in berth D-3, 18 nmi (33 km) south of MIKE crater.
- KING (1130, 16 November)
 - USS Oak Hill. At 0535 on 16 November underway for operating area. At 1742 anchored in berth B-2, 11 nmi (20 km) south of KING surface zero.
 - USS Agawam. Underway at 0801 on 16 November, arriving on station at 0844, 1,500 yards (1.4 km) astern of Collins. Returned to Enewetak at 1746.
 - USS Lipan. Underway at 0748 on 16 November. At 0927 on station with Agawam. At 1727 returned and anchored in berth M-2, Enewetak.

Arikara, Yuma, and Elder left for Pearl Harbor on 8 November, before the KING detonation. On 18 November, Agawam left for Kwajalein with YOG-69 in tow and Lipan left for Guam with YON-146 in tow. Oak Hill departed the PPG on 26 November with TU 132.32.1, the Navy Boat Pool.

The commanding officer of Oak Hill, a dock landing ship, exercised overall command of the task element. He also acted as Senior Officer Present Afloat for administrative matters concerning naval forces in the southern half of the lagoon. His duties included harbor control and responsibility for all Navy and MSTs ships. Together with the representative from TG 132.2, he coordinated port operations and activities of the TG 132.3 boat pool, the TG 132.2 boat pool, which had 24 Navy personnel assigned to it, and the TG 132.1 boat pool operated by H&N employees. Oak Hill provided berthing and mess facilities to Navy boat pool personnel and evacuated the boat pool for MIKE. In addition, Oak Hill provided facilities to scientists of Project 6.11 for both MIKE and KING. This assignment required special positioning of the ship to receive telemetered signals from instrumented canisters airdropped near ground zero. Hence, it operated on independent duty for both shots. Oak Hill also supported a number of other scientific projects, as indicated in Table 28. This participation included mounting gummed paper fallout collectors for Project 5.4a during MIKE.

The Navy boat pool consisted of various small craft. In conjunction with TG 132.1 and TG 132.2 boat pools, the Navy boat pool supplied water transportation throughout the atoll for Operation IVY. During the MIKE evacuation between 25 and 31 October, the Navy boat pool ferried most of the task force personnel to their assigned ships. Following the MIKE detonation on 1 November, the Navy boat pool assisted in early recovery of scientific data and instruments. It performed the same mission after KING on 16 November. Together with Oak Hill, the boat pool provided assistance to Project 11.5, before and after MIKE.

The Underwater Detection Unit monitored hydrophone systems across the entrances to Enewetak Lagoon to detect any hostile effort to penetrate the atoll. In conducting its operations, the Underwater Detection Unit worked closely with the air and surface security forces assigned to protect the PPG. Its personnel departed the PPG on 26 November.

The fueling unit consisted of the tanker, Agawam, and two yard craft: YON-146, a concrete oil barge, and YOG-69, a self-propelled fuel storage barge manned by a crew of 14. This unit provided refueling services to the ships of the task group. When Oak Hill's commanding officer was absent on independent duty, Agawam's commanding officer assumed command of TE 132.32. Agawam also participated in the gummed paper portion of Project 5.4a during MIKE.

The three towing units, fleet tugs Lipan, Yuma and Arikara, along with the net tender Elder as special mooring unit, provided the task force with towing and salvage services. In addition, they conducted a number of operations on behalf of the IVY scientific program during both shots. Projects supported by the tugs are indicated in Table 29.

The seismographic units were civilian research vessels operated by Scripps Institution of Oceanography (SIO). These two former ATA-class Navy tugs, Horizon and MV Spencer F. Baird, were manned by civilian crews and carried SIO scientists who measured ocean and geological phenomena associated with nuclear detonations. Horizon participated in both shots; it was positioned 65 nmi (120 nmi) northeast of surface zero for MIKE. Baird arrived at Bikini shortly before the KING detonation on 16 November. The ship sailed for Enewetak that same day, arriving on 17 November. Their departure dates from the PPG are not known.

Five LCUs and Lipan "were contaminated above tolerance levels [MPL were 0.002 R/hr for interior surfaces and 0.007 R/hr for exterior surfaces (Reference C.1.7.1)] while they were operating in the contaminated waters or on the contaminated beaches in the northern sections of Enewetak lagoon" (Reference C.3.2, p. 5-7). Horizon was contaminated by MIKE fallout several hours after the shot, while the ship was stationed 72 nmi (133 km) north of the shot island, Eluklab. Arikara deck log indicates that twelve crewmen were also exposed to slight radiological contamination while recovering a radioactive mooring buoy 155 nmi (287 km) northwest of Enewetak on 6 November (Reference 1.3.8, Arikara). Readings obtained from these crewmen ranged from a high of 0.003 R/hr to a low of 0.0002 R/hr hour. The Consolidated List for Arikara lists 14 personnel, none of whose badges recorded an exposure. Three of the individuals who handled the contaminated buoy appear among these names on the Consolidated List. According to the ship's log, these men had readings of 0.003 R/hr, 0.0004 R/hr, and 0.0003 R/hr before decontamination. The crew sank a second buoy with rifle fire rather than recover it.

None of these incidents resulted in an excessive radiation exposure of those involved. At the end of Operation IVY, the five LCUs and Lipan received operational rather than final radiological clearances. Arikara received a final clearance.

Task Element 132.33 (Destroyer Element)

Escort Destroyer Division Eleven, composed of Carpenter, Fletcher, O'Bannon, and Radford, made up TE 132.33. Carpenter was the flagship. TE 132.33 arrived

with Curtiss at Enewetak on 12 September. Throughout Operation IVY the destroyers conducted surface and antisubmarine searches of designated areas to detect and deny passage to unauthorized vessels, provided escorts and plane guards, were available for rescue missions, and monitored cloud sampling aircraft. In addition, O'Bannon participated in laying and collecting dan buoys for Scientific Project 5.4a.

Radford and Fletcher served as escorts in TE 132.30, the Weapons Element, during preparations for and execution of MIKE on 1 November. Before the MIKE evacuation, they patrolled the northern lagoon, providing security for Curtiss, which carried components of the MIKE device. On sortie for the shot, they screened Curtiss, 28 nmi (52 km) east of the detonation, and escorted the ship in its operating area. Carpenter also patrolled the Enewetak area before shot operations. On sortie and during postshot operations, Carpenter served as plane guard for Rendova, 32 nmi (59 km) south of the detonation. After laying dan buoys for Project 5.4a, O'Bannon took station midway between Enewetak and Kwajalein atolls about 200 nmi (371 km) south of the detonation, to serve as air control destroyer for TG 132.4 flights originating at Kwajalein Naval Air Station.

Radford and Carpenter reported radioactive fallout from MIKE in the vicinity of Enewetak from midnight to 1200 on 3 November. The fallout was most noticeable during and immediately after rainsqualls and averaged 0.001 R/hr with an occasional maximum approaching 0.003 to 0.004 R/hr (gamma).

Fourteen O'Bannon personnel and the ship's deck were accidentally contaminated on 3 November when the crew brought a radioactively contaminated dan buoy aboard. Maximum reading on personnel was 0.001 R/hr on shoes, 0.0005 R/hr on hands. The deck intensity averaged 0.0006 to 0.0007 R/hr. Both the deck and crewmember radiation levels were reduced to 0.00004 R/hr within 3 minutes. No other instances of accidental contamination occurred (Reference C.3.8, O'Bannon).

Destroyer assignments shifted for KING. Fletcher and Carpenter were assigned to a new organization, Main Body, to escort Collins, Agawam, and Lipan. Radford served as Rendova's plane guard. O'Bannon again took station midway

to Kwajalein as the air control destroyer. None of the destroyer escorts received significant contamination as a consequence of KING (Reference C.3.2, pp. 12-13).

On 17 November Fletcher, Carpenter, and Radford left Enewetak for Pearl Harbor. The day before, O'Bannon, released from air control duty, left to rendezvous with Curtiss at Kwajalein. On 18 November, all the destroyers rendezvoused to escort Curtiss on its return voyage to Pearl Harbor. Upon reaching Pearl Harbor on 23 November, the destroyers were released from TG 132.3 operational control. Summaries from the ships' deck logs of their operational activities during Operation IVY follow.

● MIKE (0715, 1 November)

- USS O'Bannon. Laid buoys for Project 5.4a on 31 October. At 0430 on 1 November arrived at control destroyer station. Between 2 and 6 November recovered buoys. At 2204 on 3 November, 14 men were contaminated by a buoy reading 0.0006 to 0.0007 R/hr. All men and shipboard area decontaminated to 0.00004 R/hr by 2207.
- USS Fletcher. After patrol to the north, arrived on station to patrol area off Deep Entrance. At 0412 joined Curtiss, 28 nmi (52 km) east of shot site. At 1534 on 2 November arrived at Kwajalein.
- USS Radford. After northern patrol, screened Curtiss in 3C2 after 0400 on 1 November. Ship located 28 nmi (52 km) east of shot site. After detonation, began patrol of eastern sector. Returned to Enewetak on 9 November.
- USS Carpenter. At 2153 on 31 October, joined Rendova in patrol south of Enewetak. Acted as Rendova plane guard, 32 nmi (59 km) south of shot site. Continued patrol south of Enewetak and did not return to Enewetak until 8 November.

● KING (1130, 16 November)

- USS O'Bannon. At control destroyer station during shot. At 1705 proceeded to Kwajalein, from 200 nmi (371 km) south of shot site.
- USS Fletcher. Left Enewetak at 0635 on 16 November. On station with Carpenter, Collins, Agawam, and Lipan during shot. Anchored in berth D-6, Enewetak, 11 nmi south of shot site at 1741.
- USS Radford. On 15 November between 0930 and 1008, the radsafe team aboard declared the ship safe. At 0817 on 16 November, proceeded to plane guard station for Rendova. Remained as plane guard during shot and flight operations 1220 to 1559. Anchored in berth D-5, 11 nmi (20 km) south of surface zero, at 1665.

-- USS Carpenter. At 0915 on 16 November took station with Fletcher, Collins, Agawam, and Lipan. At 1621, after shot, dissolved formation and anchored in berth D-4, anchorage A, Enewetak, 11 nmi (20 km) south of shot site.

Limited radiological exposure information is available on the crew of three of the four escort destroyers. There are no radiological exposure data for Radford. According to the limited data available, no one among the crews of these ships received an excessive radiation exposure (see Table 28). All four ships received a final radiological clearance after Operation IVY (Reference C.3.2, pp. 12-14). Radford's washdown system was so highly regarded that it served as a model installation for the upcoming CASTLE test series (Reference C.3.7). No ship's crew or embarked staff had an exposure greater than 0.5 R.

Task Unit 132.3.0 (Carrier Unit)

TU 132.3.0 was composed of the escort carrier Rendova, Helicopter Anti-Submarine Squadron Two (HS-2) with three HRS-2s, a Marine Corps detachment with two HRS-2s, Fleet Composite Squadron Three (VC-3) detachment with six F4U-5N Corsair propeller-driven fighter aircraft, and Fleet Aircraft Service Squadron Seven (FASRON-7) detachment with four TBM-3R, single-engine torpedo bombers converted to transports.

This unit provided air transportation for radiological surveys, scientific data recoveries, radioactive sample returns, and other JTF 132 activities. Rendova served as the base during the MIKE evacuation, the aircraft otherwise being at Enewetak, and the basic airlift mission was carried out by a Navy detachment formed of three HRS-2 helicopters, twelve pilots, and twenty-two maintenance personnel from HRS-2, and a Marine Corps detachment of eight pilots and six enlisted men from several Marine Corps air units.

Exposures among this group were the highest in TG 132.3, with a Marine Corps pilot receiving 2.815 R. Highest among the Navy personnel was a pilot in HS-2 with 2.295 R. The mission of FASRON-7 was to fly radioactive samples recovered by helicopter from Rendova to Kwajalein using their TBMs, which had been modified as carrier-based transports. However, because reentry to Enewetak was much quicker than expected this was not necessary, and these TBMs were not used for this purpose (Reference C.3.2, p. 13D-1). No exposure information

is available for FASRON-7. VC-3, with its Corsair fighters, was intended to provide air defense had the need arisen. No exposure information is available for VC-3 personnel.

On 15 September 1952, Rendova left San Diego with its assigned air group aircraft plus sixteen F-84Gs to be used by TG 132.4 for cloud sampling, and four C-47s to be used in interatoll airlift. Also aboard Rendova for the operation were two Army Signal Corps trailers to be used by TU 132.1.7 in radsafe operations as radiological and photodosimetry laboratories. The C-47s were offloaded at Pearl Harbor 21-23 September, and the F-84Gs were transported to Kwajalein, 30 September-1 October. Rendova arrived at Enewetak on 2 October.

Commander TG 132.3 transferred with his staff to Rendova on 4 October. Tasks assigned to TU 132.3.0 were generally carried out as planned. Table 29 identifies the IVY scientific projects supported by Rendova.

On the day before MIKE, Rendova took aboard the three F4Us of VC-3, and later, at 1740, completed the evacuation of TG 132.1 personnel. At 2058 it was underway for its operating position of 32 nmi (59 nmi) south of surface zero after taking aboard the Air Force crash crew.

After the shot, helicopter No. 28 attempted a radiation survey. It returned contaminated and radiating 2 R/hr at 0821. At 0938, two TBMs were launched. These returned at 1718. Helicopters were launched and recovered from 0957 to 1839. Another contaminated helicopter (1.5 R/hr) returned at 1126. The next day helicopter activity lasted throughout the day. Rendova moored to buoy L-4 at Enewetak, 25 nmi (46 km) from MIKE crater, at 1910 (Reference C.3.8, Rendova).

For the KING test, Rendova sortied and supported flight operations throughout the day following the shot. It returned to Enewetak at 1655 and anchored in C-2 (Reference C.3.8, Rendova).

Navy helicopters left the carrier at H+10 minutes to make the initial aerial survey of the atoll after both MIKE and KING. Helicopter crewmembers received the highest radiation exposures in the carrier unit, 2.815 for a

member of Marine Component Air Department, primarily because of their initial radiation surveys of Enewetak Atoll.

Rendova departed the PPG on 20 November. The ship and one of its helicopters were granted a final radiological clearance on 2 December 1952. The remaining four helicopters had measured radiation levels exceeding 0.015 R per 24 hours, beta plus gamma, and therefore did not qualify for a final clearance. They were granted an operational clearance on 2 December with the requirement for a resurvey of contaminated areas within the next quarter (Reference C.3.1, p. 47).

Task Unit 132.3.1 (Patrol Plane Unit)

TU 132.3.1 was composed of Patrol Squadron Two (VP-2) based at Whidbey Island, Washington, augmented by two PBM-5A amphibious aircraft from Fleet Aircraft Service Squadron 110 (FASRON-110) from San Diego. During Operation IVY, VP-2 operated nine P2V-4 and three P2V-5 aircraft. Both components of the task unit operated out of Kwajalein Naval Station.

Movement of the VP-2 aircraft commenced from their home base at Whidbey Island, Washington, on 15 August. All the P2V aircraft except one arrived at Kwajalein on 21 August. The remaining aircraft arrived on 14 October. The last P2V was delayed for installation and testing of special equipment needed to support Project 6.7a. The two PBM-5A amphibians departed the United States on 23 August and arrived at Kwajalein on 2 September (Reference C.3.2, pp. 4-8, 4-9). The PBM-5As participated in the AEC World-Wide Fallout Monitoring Program.

The maximum listed exposure for personnel in the patrol plane unit was 0.080 R. VP-2 departed Kwajalein on 20 November and received its final radiological clearance on 2 December.

Table 30 summarizes the arrival and departure dates for all TG 132.3 units.

NON-JTF 132 NAVY UNITS IN IVY

Transport Squadron Three (VR-3). Fifteen badged personnel of this squadron appear in the Consolidated List. This unit was involved with air transport

Table 30. Operation IVY, Task Group 132.3 arrival and departures -- Pacific Proving Ground.

Task Element Number (Unit Name)	Component	Reported for Operational Control	Arrival	Released from Operational Control	Departure	Comments
TE 132.30 (Weapons Element)						
TU 132.30.0	<u>USS Curtiss (AV-4)</u>	27 August (SF)	12 September (E)	2 December	18 November	
TE 132.31 (Transport Element)						
TU 132.31.0	<u>USS Estes (AGC-12)</u>	27 August (SF)	18 September (E)	6 December	19 November	
TU 132.31.1	<u>LST-836</u>	4 August (PH)	12 September (E)	10 December	25 November	Rolled up weather stations following KING
TU 132.31.2	<u>USNS General E.T. Collins (T-AP-147)</u>	20 October (E)	20 October (E)	20 November	20 November	
TU 132.31.3	<u>USNS David C. Shanks (T-AP-180)</u>	18 October (E)	18 October (E)	11 November	11 November	
TU 132.31.4	<u>USS Leo (AKA-60)</u>	20 October (E)	20 October (E)	26 November	26 November	
TE 132.32 (Service and Harbor Control Element)						
TU 132.32.0	<u>USS Oak Hill (LSD-7)</u>	1 August (E)	30 July (E)	16 December	26 November	
TU 132.32.1	Boat pool	N/A	30 July (E)	16 December	26 November	Advance group of one officer and 21 enlisted men arrived by air 21 July, remainder arrived on board <u>USS Oak Hill</u>
TU 132.32.2 (Fueling Unit)	<u>USS Agawam (AOG-6)</u>	7 July (E)	7 July (E)	16 November	18 November	Towed YOG-69 to Kwajalein
	<u>YON-146</u>	30 July (E)	21 July (E)	16 November	18 November	Arrived under tow by <u>USS Mactobi (ATF-105)</u>
	<u>YOG-69</u>	30 July (E)	26 July (E)	16 November	18 November	Arrived under tow by <u>USS Takeima (ATF-118)</u>
TU 132.32.3 (Towing Unit)	<u>USS Lipan (ATF-85)</u>	21 October (E)	21 October (E)	16 November	18 November	Towed YON-146 to Guam
TU 132.32.4 (Towing Unit)	<u>USS Yuma (ATF-94)</u>	20 October (E)	20 October (E)	7 November	8 November	
TU 132.32.5	Underwater detection unit	N/A	30 July (E)	16 December	26 November	Arrived by air 17 July

(continued)

Table 30. Operation IVY, Task Group 132.3 arrival and departures -- Pacific Proving Ground (continued).

Task Element Number (Unit Name)	Component	Reported for Operational Control	Arrival	Released from Operational Control	Departure	Comments
TE 132.32 (continued)						
TU 132.32.6 (Towing Unit)	USS <u>Arikara</u> (ATF-98)	20 October (E)	20 October (E)	8 November	8 November	Left with <u>USS Elder</u> (AN-20)
TU 132.32.7 (Seismographic Unit)	MV <u>Spencer F. Baird</u>	28 October	14 November (B)	22 November	N/A	Not present for MIKE; at Bikini for KING
TU 132.32.8 (Seismographic Unit)	MV <u>Horizon</u>	15 October (E)	15 October (E)	22 November	N/A	
TU 132.32.9 (Special Mooring Unit)	USS <u>Elder</u> (AN-20)	21 October (E)	21 October (E)	4 November	8 November	
TE 132.33 (Destroyer Element)						
TU 132.33.0	USS <u>Carpenter</u> (DDE-825)	1 September (PH)	12 September (E)	23 November	17 November	
TU 132.33.1	USS <u>Fletcher</u> (DDE-445)	1 September (PH)	12 September (E)	23 November	17 November	
TU 132.33.2	USS <u>Radford</u> (DDE-446)	1 September (PH)	12 September (E)	23 November	17 November	
TU 132.33.3	USS <u>O'Bannon</u> (DDE-450)	1 September (PH)	12 September (E)	23 November	17 November	
TE 132.34 (Convoy and Escort Element)						
TU 132.34.0	USS <u>Curtiss</u> (AV-4)	27 August (SF)	12 September (E)	2 December	18 November	
TU 132.3.0 (Carrier Unit)	USS <u>Rendova</u> (CVE-114)	15 September (SD)	2 October (E)	2 December	20 November	
	6 <u>F4U-5N</u>		2 October			
	4 <u>TBM-3R</u>		2 October			
	5 <u>HRS-2</u>					
TU 132.3.1 (Patrol Plane Unit)	VP-2	12 September	21 August (K)	19 November	20 November	
	8 P2V-4		21 August (K)			
	1 P2V-4		14 October (K)			
	3 P2V-5		21 August (K)			
	2 PBM-5A	2 September	2 September (K)	20 November		

Note: N/A Not Available; (B) Bikini; (E) Enewetak; (K) Kwajalein; (PH) Pearl Harbor; (SD) San Diego; (SF) San Francisco
Sources: References C.0.1 and C.3.1.

operations into the PPG as part of Military Air Transport Service (MATS) and may have flown out cloud samples. High exposure was 0.120 R.

Transport Squadron Eight (VR-8). One man from this squadron was badged. His exposure was 0.098 R. His duties during IVY are not known.

CHAPTER 7
U.S. AIR FORCE PARTICIPATION IN OPERATION IVY

Over 2,600 Air Force personnel participated in Operation IVY. They were drawn from more than 60 organizations throughout the United States and the Territory of Hawaii. Air Force personnel were assigned to Joint Task Force 132 (JTF 132) Headquarters, Task Group 132.1 (TG 132.1), and TG 132.2, as well as the Air Force task group, TG 132.4. Over 2,000 Air Force personnel were stationed on Kwajalein, approximately 500 on Enewetak, and 100 on four remote islands -- Bikini, Ponape, Kusaie, and Majuro -- used as weather stations. TG 132.4 missions included cloud sampling, nuclear device airdrop, blast and thermal measurements on aircraft, photography, weather reconnaissance, search and rescue (SAR), and operation of the JTF 132 Weather Central. They also operated 21 light aircraft for interisland transportation at Enewetak Atoll.

Cloud sampling in previous test series in the Pacific had been done by directing unmanned radio-controlled aircraft through the radioactive clouds. For IVY, the decision was made to sample by flying manned F-84G fighters through the clouds to sample. Pilots were sent to Nevada for training in radioactive cloud penetration during Operation TUMBLER-SNAPPER. Radiation exposures for these pilots during Operation IVY were low, with the highest exposure less than 3.5 R, and most less than 1 R. Two incidents occurred in which Air Force personnel received high exposures. The first was when an SA-16 SAR aircraft flew through a portion of the MIKE cloud attempting to reach an F-84G sampler pilot who had run out of fuel and was ditching in the ocean. The crew of the SA-16 received exposures of 10 and 17.8 R. The second incident was when a C-54 aircraft that was photographing the MIKE crater inadvertently flew through a portion of the cloud. Exposures for the crew averaged around 10 R.

Exposure information for Air Force personnel during Operation IVY is fairly complete and accurate for those who were badged. Only those who had duties where exposure was possible were badged. Of the Air Force personnel who participated in IVY, only 675 were badged. Badges were normally issued for a single day (or mission) and then turned in and processed. Although MIKE and

KING produced low-level fallout on islands in the test area (see Chapter 10), it was not a serious problem because most were stationed at areas remote from Enewetak Atoll and exposures were minor for those in the test area.

Exposure information for Air Force personnel is presented here by functional task force organization. Table 31 lists each task force organization that had badged Air Force personnel and shows the units that furnished those personnel, where known. In some cases, personnel listed only their functional task force organization on their 5x8 cards so, for example, Task Unit (TU) 132.4.1 (Test Support Unit) is listed under Test Support Unit (TSU). Fifteen agencies are listed under Miscellaneous because these units and bases could not be associated with a functional task force organization. Table 32 provides exposure information for each of the task force organizations shown in Table 31.

HEADQUARTERS JOINT TASK FORCE 132

Records indicate that 34 Air Force personnel were in this headquarters unit. Five of these were badged at least once during IVY and their exposures, which were quite low, are shown in Table 32.

TASK GROUP 132.1 (SCIENTIFIC)

Thirty-three Air Force personnel were assigned to the scientific task group. Table 31 shows that 19 organizations furnished Air Force personnel for this task group. Those from Los Alamos Scientific Laboratory (LASL) were probably research associates who were stationed there for a 3-year tour. The same is probably true of those from Naval Research Laboratory (NRL) and Edgerton, Germeshausen & Grier (EG&G). Those from Detachment A, Sandia Base, may have been working with Sandia Corporation at the test site. Those with Hq USAF were concerned with Program 7 experiments (see Chapter 3). The remaining 14 organizations (or locations) furnished officers and men for the TU 132.1.7 radsafe organization.

TASK GROUP 132.2 (ARMY)

Two Air Force men listed TG 132.2 as their place of duty. Since an Air Force detachment on Enewetak operated the airbase, it is possible that these men were liaison officers assigned to the Army task group. Their exposures were quite low (Table 32).

Table 31. Air Force personnel badged for IVY and task group assignment.

Unit Designation	No. of Persons Badged
Headquarters, Joint Task Force 132	5
Task Group 132.1 (Scientific)	
Task Group 132.1 Headquarters	5
Los Alamos Scientific Laboratory, Los Alamos, New Mexico	4
Naval Research Laboratory, Washington, D.C.	4
Detachment A, Sandia Base, New Mexico	1
Hq USAF, Washington, D.C.	2
Edgerton, Germeshausen & Grier, Boston, Massachusetts	3
Task Unit 132.1.7 (Radiological Safety)	
Air Force Cambridge Research Center, Cambridge, Massachusetts	1
Air Defense Command, Colorado Springs, Colorado	1
435th Aircraft Installation Squadron, Miami, Florida	1
Air Training Command, Scott AFB, Illinois	1
Chanute AFB, Illinois	1
Bryan AFB, Texas	1
Francis E. Warren AFB, Wyoming	1
Hunter AFB, George	1
Sewart AFB, Tennessee	1
3398th Training Squadron, Keesler AFB, Mississippi	1
3882nd School Squadron, Gunther AFB, Alabama	1
Lackland AFB, Texas	1
Webb AFB, Texas	1
Selfridge AFB, Michigan	1
Task Group 132.2 (Army)	2
Headquarters, Task Group 132.4 (Air Force)	
Task Group 132.4, Kwajalein	33
Air Force Special Weapons Center, Kirtland AFB, New Mexico	32
4925th Test Squadron, Kirtland AFB, New Mexico	3
FPO 824	2
Test Support Unit	
4930th Test Support Group, Kirtland AFB, New Mexico	7
4908th Motor Vehicle Squadron, Kirtland AFB, New Mexico	1
TU 132.4.1 (Test Support Unit)	31
Headquarters, Test Aircraft Unit	
Hq Strategic Air Command, Offutt AFB, Nebraska	14
TU 132.4.2 (Test Aircraft Unit)	5
3902nd Air Base Wing, Offutt AFB, Nebraska	3
12th Air Division, McClellan AFB, California	1
93rd Bombardment Wing, Castle AFB, California	1

(continued)

Table 31. Air Force personnel badged for IVY and task group assignment
(continued).

Unit Designation	No. of Persons Badged
Test Aircraft Unit Sampler Element	
12th Fighter-Escort Wing, Bergstrom AFB, Texas	10
27th Fighter Wing, Bergstrom AFB, Texas	2
561st Fighter-Escort Squadron, Bergstrom AFB, Texas	2
Bergstrom AFB, Texas	26
Test Aircraft Unit Drop Element	
7th Bombardment Wing, Carswell AFB, Texas	16
11th Bombardment Wing, Carswell AFB, Texas	33
42nd Bombardment Squadron, Carswell AFB, Texas	1
19th Air Division, Carswell AFB, Texas	1
Carswell AFB, Texas	2
Test Aircraft Unit Control and Tanker Elements	
307th Air Refueling Squadron, Walker AFB, New Mexico	79
509th Bombardment Wing, Walker AFB, New Mexico	27
Walker AFB, New Mexico	28
Roswell, New Mexico	6
Test Aircraft Unit Effects Element	
6520th Flight Test Squadron, Hanscom AFB, Massachusetts	24
Air Force Cambridge Research Center, Cambridge, Massachusetts	1
Air Research and Development Command, Baltimore, Maryland	1
3160th Electronic Group, Cambridge, Massachusetts	2
Wright Air Development Center, Wright-Patterson AFB, Ohio	7
Headquarters, Test Services Unit	
TU 132.4.3 (Test Services Unit)	1
47th Air Transport Squadron, Hickam AFB, Hawaii	5
48th Air Transport Squadron, Hickam AFB, Hawaii	5
50th Air Transport Squadron, Hickam AFB, Hawaii	6
1254th Air Transport Squadron, Bolling AFB, Washington, D.C.	8
Pacific Division, Military Air Transport Service, Hickam AFB, Hawaii	15
Test Services Unit Weather Reconnaissance Element	
57th Strategic Reconnaissance Squadron, Hickam AFB, Hawaii	42
Task Element 132.4.3.1 (Weather Reconnaissance Element)	17
Test Services Unit Weather Reporting Element	
6th Weather Squadron, Tinker AFB, Oklahoma	13
9th Weather Group, Tinker AFB, Oklahoma	1

(continued)

Table 31. Air Force personnel badged for IVY and task group assignment
(continued).

Unit Designation	No. of Persons Badged
Test Services Unit Weather Reporting Element (continued)	
1500th Weather Reporting Squadron, Hickam AFB, Hawaii ^a	10
Task Element 132.4.3.2 (Weather Reporting Element)	1
Test Services Unit Communications Element	
1810th Airways and Air Communications Svc Sqdrn, Hickam AFB, Hawaii	1
Test Services Unit Search and Rescue Element	
11th Air Rescue Squadron, Hickam AFB, Hawaii	47
Test Services Unit Photo Element	
6th Air Division, MacDill AFB, Florida	2
306th Bombardment Wing, MacDill AFB, Florida	1
2nd Bombardment Wing, Hunter AFB, Georgia	1
338th Strategic Reconnaissance Squadron, Forbes AFB, Kansas	13
1352nd Motion Picture Squadron, Los Angeles, California	8
523rd Motion Picture Squadron, Los Angeles, California ^b	7
15th Bombardment Wing, Hickam AFB, Hawaii	6
USAF Lookout Mountain Laboratory, Los Angeles, California	12
Miscellaneous	
3536th OTS, Mather AFB, California	1
Davis Monthan AFB	2
McClellan AFB, California	1
Rapid City AFB, South Dakota	1
APO 953 (Hickam AFB, Hawaii)	7

Notes:

^aNo such permanent or provisional Air Force unit existed. Therefore, this was erroneously reported in the Consolidated List, or possible was a temporary unit supported by the 1500th Air Base Group, at Hickam AFB, Hawaii.

^bNo such unit existed. This may have been a garbled entry in the Consolidated List for the 1352nd Motion Picture Squadron.

Table 32. IVY personnel exposures, U.S. Air Force organizations.

Organization	No. of Persons Badged	Exposure Ranges (roentgens)												Over 15	Over 3.9 ^a	
		0	0.001-0.5	0.5-1	1-1.5	1.5-2	2-2.5	2.5-3	3-4	4-5	5-10	10-15				
Hq Joint Task Force 132	5	2	2	1												
Task Group 132.1	18	3	7	2	4	1	1									
Task Unit 132.1.7	14	2	2	4	3	1	3	1								
Task Group 132.2	2	1		1												
Task Group 132.4																
Hq Task Group 132.4	70	5	57	3	3	1	1	1								
Test Support Unit	39	6	30	1	2											
Hq Test Aircraft Unit (TAU)	24		24													
TAU Sampler Element	40		27	5	4	1	1									
TAU Drop Element	53	18	35													
TAU Control and Tanker Elements	140	7	124	9												
TAU Effects Element	35	9	26													
Hq Test Services Unit (TSU)	40	13	27													
TSU Weather Reconnaissance	59	2	54	1	1	1										
TSU Weather Reporting	25	4	21													
TSU Communications	1		1													
TSU Search and Rescue	47	5	35											2	3	2
TSU Photo	51	3	29	1	4	2								6	6	12 ^c
Miscellaneous	12		12													
Totals	675	78	513	28	21	6	5	2	3	0	8	9	2	19		

Notes:

^aBasic Maximum Permissible Exposure -- 3.9 R per 13-week period.

^bLowest two readings were 10 R; highest reading was 17.8 R.

^cAll twelve readings were over 5 R; highest reading was 11.6 R.

Source: Reference C.1.7.2.

TASK GROUP 132.4 (AIR FORCE)

Headquarters Task Group 132.4

Thirty-three badged persons listed "TG 132.4" as their duty station (see Table 31). It is improbable that all 33 were assigned to the headquarters element; however, lacking more definite information, they have been placed here. Also, 32 badged persons listed AFSWC (or Kirtland AFB) as their duty station. Again, it is improbable that all these people were assigned to the headquarters element. Two people who listed FPO 824, the post office designation for Kwajalein, have been listed here for the same reason. Table 32 indicates that all exposures were less than 3 R. Headquarters for TG 132.4 was located on Kwajalein.

Test Support Unit

This unit operated the airbase at Enewetak and assisted in operation of the airbase at Kwajalein. It operated four C-47s out of Kwajalein for inter-atoll transport and for photographic missions. It also operated 15 light aircraft and 6 helicopters out of Enewetak for transport to the various islands within the atoll. Personnel strength at Kwajalein was approximately 650 and at Enewetak approximately 250. Only 39 people in this unit were badged; all had low readings (Table 32).

Test Aircraft Unit

HEADQUARTERS TEST AIRCRAFT UNIT. The 14 men who indicated Hq Strategic Air Command (SAC) as their unit when they were badged were placed in Test Aircraft Unit (TAU) in this report because SAC was responsible for organizing it. The 3902nd Air Base Wing was collocated with Hq SAC at Offutt AFB and for that reason was also placed in the TAU headquarters. Five people listed TU 132.4.2 as their organization (Table 31), which is the numerical designation for the TAU. Table 32 shows very low exposures for Hq TAU personnel.

TAU SAMPLER ELEMENT. This element operated 16 F-84G aircraft to obtain gaseous and particulate samples from the radioactive clouds. They were based at Kwajalein and flew to Enewetak and back for both MIKE and KING. Because of limited fuel capacity they were refueled by KB-29 tankers en route. Table 31 shows that 26 persons listed simply "Bergstrom AFB" as their organization. Since all the sampler personnel came from units at Bergstrom, they have been

listed with the Sampler Element. Table 32 shows that exposures were relatively high, which is to be expected based on their mission. One of the sampler pilots was lost and apparently drowned following MIKE.

TAU DROP ELEMENT. This element, stationed on Kwajalein, was responsible for dropping KING from a B-36 aircraft. The element had two B-36s, one of which was used to help control the F-84G samplers. More than half of the people in this element were badged at least once during IVY. Table 32 reflects their exposures, which were very low (below 0.5 R) or zero.

TAU CONTROL AND TANKER ELEMENTS. These two elements have been combined for discussion purposes because personnel from the 307th Air Refueling Squadron* and the 509th Bombardment Wing at Walker AFB manned both elements and the number in each element cannot be determined. Personnel listing Walker AFB and Roswell, New Mexico (the location of Walker AFB), have been included in these elements since all other personnel from Walker AFB were in these elements (Table 31). The Control Element operated two B-50s and two B-29s. The B-50s were used for experimental projects (air attenuation, transit time, and indirect bomb damage assessment [IBDA]), see Chapter 3). The B-29s were used to vector the F-84G samplers to and from Enewetak. The Tanker Element operated ten KB-29 aircraft to refuel the F-84G sampler aircraft en route to and from Enewetak. All personnel from these two elements were stationed on Kwajalein. Table 32 shows that their exposures were all less than 1 R.

TAU EFFECTS ELEMENT. This element operated two B-29s, a B-36, and a B-47, each instrumented to measure blast and temperature effects from the nuclear detonations. The 6520th Flight Test Squadron provided the B-29 aircraft. The B-29s also dropped instrumented canisters before each shot, which were used to measure variations in altitude, temperature, and pressure before and after detonation of the nuclear devices. Wright Air Development Center (WADC) sponsored the experimental projects (Projects 6.10 and 8.5) associated with the B-36 and B-47, while Air Force Cambridge Research Center (AFCRC) sponsored Project 6.11

* This squadron was misidentified in the Consolidated List as the 307th Air Reconnaissance Squadron.

associated with the B-29s. All persons in this element were stationed on Kwajalein. Except for three men with exposures between 1 and 3 R, all exposures were very low. Specific duties of these three are not known.

Test Services Unit

Test Services Unit (TSU) consisted of five elements -- Weather Reconnaissance, Weather Reporting, Communications, Search and Rescue, and Photo. There were also four air transport squadrons -- 47th Air Transport Squadron, 48th Air Transport Squadron, 50th Air Transport Squadron, and 1254th Air Transport Squadron -- that ferried personnel and equipment to and from the test area. These were not part of one of the subordinate elements and are therefore discussed and shown in the tables under "Hq Test Services Unit." Pacific Division, Military Air Transport Services (PACD, MATS) is also carried under Hq TSU since MATS was responsible for organizing the TSU. Persons in the air transport squadrons moved among Kwajalein, Enewetak, and Hawaii. Those from PACD, MATS were stationed at Kwajalein. Exposures are reflected in Table 32.

TSU WEATHER RECONNAISSANCE ELEMENT. This element operated ten WB-29 aircraft to provide long-range weather reconnaissance information to the task force. These aircraft were also used to gather radioactive cloud samples for Hq USAF under Project 7.3. All ten WB-29s were equipped with C-1 filters to collect particles and four were equipped with B/31 gas-sampling systems. A person from TG 132.4, Hq USAF Element, was on board one of the WB-29s during cloud-sampling activities to direct the sampling effort. All men in this element were stationed on Kwajalein. Exposures are presented in Table 32.

TSU WEATHER REPORTING ELEMENT. This element manned weather reporting stations at Enewetak, Kwajalein, Ponape, Majuro, Kusaie, and Bikini, and operated JTF 132 Weather Central on Parry Island. Of the approximately 120 people in this element, only 25 were ever badged. Their exposures, given in Table 32, were quite low.

TSU COMMUNICATIONS ELEMENT. This element operated the communications systems and navigational aids necessary to support the TG 7.4 aircraft. Of the more than 150 people in this element only one was badged. His exposure was quite low. Persons from this element were located at Kwajalein, Enewetak, and the four remote weather islands.

TSU SEARCH AND RESCUE ELEMENT. This element operated two SA-16 and two SB-29 SAR aircraft in support of the task force. The Navy also had 12 P2V aircraft and two PBM amphibious aircraft at Kwajalein, which could be used for SAR if needed. The Air Force SAR element was based at Kwajalein and deployed its aircraft near Enewetak for both shots. When an F-84G sampler pilot ran out of fuel and ditched near Enewetak Island, an SA-16 flew through a portion of the MIKE cloud attempting to reach him (he was never found). The seven exposures at or above 10 R in Table 32 are the result of this incident. The highest exposure recorded for the test series, 17.8 R, was one of these men. Exposures for other badged persons in this element were very low or zero.

TSU PHOTO ELEMENT. This element was based on Kwajalein and operated three C-54 and one RB-50 aircraft as still and motion picture photography platforms. Two C-47s from TSU were also used for radioactive cloud photography at H-hour and at 1-minute intervals for 1 hour. The RB-50 crash-landed at Enewetak before the first shot and burned on the runway. Although a replacement RB-50 arrived just before the MIKE shot, it was not checked out, and a C-54 took crater photos after the MIKE shot. This aircraft arrived at its photo station too early and flew through a portion of the MIKE cloud and was contaminated. The 12 high exposures shown in Table 32 are the result of this incident.

The TSU Photo Element had approximately 65 people assigned to it, 51 of whom were badged at least once during IVY. Table 31 lists the several units that furnished personnel for this element. A Documentary Photography Element was also in the scientific task group, TU 132.1.9. It was authorized 22 military and 2 civilians on Kwajalein and 8 military and 15 civilians on Parry (see Table 4, Chapter 1). This element directed the activities of the TSU Photo Element. In fact, there is some question as to whether these two units were separate entities, or whether some personnel were counted in both units.

Miscellaneous

Table 31 lists 5 units and bases that cannot be associated with a specific functional element of the task force. Only 12 people are listed from these 5 locations. Their exposures are shown in Table 32. No one exceeded the 3.9 R MPE.

SECTION 8
SUMMARY OF U.S. MARINE CORPS PARTICIPATION IN IVY

Nearly 180 Marines participated in IVY. Their contribution ranged from activities closely associated with the experimental program, such as helicopter and radiological safety (radsafe) support, to more general support as ships' company and Kwajalein detachment personnel.

Marine Corps organizations were represented in the Scientific Task Group (TG 132.1) and in the Navy Task Group (TG 132.3). In TG 132.1, four Marines worked in TU 132.1.7 (Radsafe) as monitors and in decontamination work. In TG 132.3, 67 Marines were part of the ships company of the USS Curtiss of TU 132.30.0 of the Weapons Element, but none appear on the Consolidated List (Reference C.1.7.2). The USS Estes, TU 132.31.0 of the Transport Element, had five Marines as a part of its ships company, none of whom appear on the Consolidated List.

Members of several Marine Corps units served in the Air Department of USS Rendova, where they piloted helicopters and performed maintenance and service. This group included 14 officers and enlisted men. Ten were badged; exposures for these are shown in Table 33, the highest being 2.815 R.

A 93-man contingent of Marines was at the naval base on Kwajalein during the IVY testing period, but none of these appear on the Consolidated List, implying no badging and no expected exposure.

Table 33. IVY personnel exposure, U.S. Marine Corps organizations.

Organization	No. of Persons Badged	Exposure Ranges (roentgens)						
		0	0.001-0.5	0.5-1	1-1.5	1.5-2	2-2.5	Over 2.5
TG 132.1 (TU 7, Radsafe)								
2nd Marine Div (Camp LeJeune, NC)	2			1	1			
3rd Marine Div (Camp Pendelton, CA)	1						1	
Recruit Depot (Parris Island, SC)	1						1	
TU 132.3 (Carrier Unit)								
Air Department	10	2	3		1	2	1	1 ^a

Note:

^aHigh was 2.815 R.

Source: Reference C.1.7.2.

CHAPTER 9

SUMMARY OF JOINT DEFENSE, ATOMIC ENERGY COMMISSION, OTHER GOVERNMENT AGENCIES, AND CONTRACTOR PARTICIPATION IN IVY

JOINT DEFENSE AGENCY

The only Joint Defense Agency other than Joint Task Force 132 (JTF 132) that participated in IVY was the Armed Forces Special Weapons Project (AFSWP). This organization was made up of service personnel as well as civilians. It was involved in planning and coordinating Department of Defense (DOD) participation in the nuclear testing. AFSWP had its headquarters in Washington, D.C., and a field activity designated "Field Command" (FC) at Sandia Base, New Mexico. AFSWP personnel usually worked at the program level at the test site, but on occasion worked on projects. Only three men were badged at IVY, although a larger contingent was probably at the Pacific Proving Ground (PPG). Of the three badged, two were from Hq AFSWP, and their function has not been identified. The naval officer from AFSWP-FC was a Task Unit (TU) 132.1.7 radiological safety (radsafe) engineer. Exposures are given in Table 34.

ATOMIC ENERGY COMMISSION

The Atomic Energy Commission (AEC) was an executive agency established by the Atomic Energy Act of 1946 that was charged with the development of nuclear weapons. This was a civil agency, but had military personnel serving within it and stationed at its weapon development laboratories.

The AEC owned several laboratories that were operated by universities and other large contractors at which most of the scientific work took place, and personnel from these government-owned, contractor-operated laboratories were heavily represented in IVY.

Los Alamos Scientific Laboratory (LASL), Los Alamos, New Mexico. LASL was the most important of the AEC laboratories. LASL was operated by the University of California and its personnel were university employees and military personnel on duty there. The explosive devices were designed and developed at LASL, and the laboratory fielded many experiments to measure their performance. The total number of military personnel from LASL in the task force cannot be extracted from WT-636 (Reference C.1.3.636), but

Table 34. IVY personnel exposure, joint defense, Atomic Energy Commission, other government agencies, and contractor organizations.

	No. of Persons Badged	Exposure Ranges (roentgens)							
		0	0.001-0.5	0.5-1	1-1.5	1.5-2	2-2.5	2.5-3	Over 3
Joint DOD									
AFSWP Hq	2					1		1	
AFSWP-FC	1						1		
Total Joint DOD	3					1	1	1	
AEC									
AEC Hq	3	1	2						
AEC Div Bio&Med	1	1							
AEC SF Ops Office	7	3	4						
LASL (Civilian)	47	7	19	5	6	4	3	2	1 ^a
LASL (Military)	20		9	7	1	1	1		1
UCRL Berkeley	5		1	1	2			1	
ORNL	1			1					
Sandia Corp	19		3	4	5	6	1		
Total AEC	103	12	38	18	14	11	5	3	2
Other Gov't Agencies									
FCDA	1		1						
VIP	2	1	1						
Total Other Gov't	3	1	2						
Contractors and Other Organizations									
ARA	1	1							
American Red Cross	1	1							
EG&G	18	1	8	6	3				
H&N	227	29	132	32	19	4	4	6	1 ^b
Holter Res.	1		1						
Tracer Lab	1		1						
UCLA	3		3						
Univ of Wash, AFL	6		1	3	1	1			
Total Contractors	258	32	146	41	23	5	4	6	1
Grand Total	367	45	186	59	37	17	10	10	3

Notes:

^aLASL (Civ) high = 3.09 R.

^bH&N high - 3.165 R.

Source: Reference C.1.7.2.

the total number who are on the Consolidated List (Reference C.1.7.2) with LASL as the indicated home unit is 20. Exposures for LASL personnel are given in Table 34.

University of California Radiation Laboratory (UCRL), Berkeley, California.

Five men from this AEC-sponsored laboratory manned Projects 5.2 and 5.3. All were badged.

Oak Ridge National Laboratory (ORNL), Oak Ridge, Tennessee. ORNL provided at least one person to JTF 132; he worked in TU 132.1.7.

Sandia Corporation, Albuquerque, New Mexico. This AEC contractor staffed Projects 2.5, 6.1, 6.3, 6.5, 6.7b, and the arming and firing task unit. Sandia staff at the Pacific Proving Ground (PPG) was 67 (Reference C.1.3.636), of whom 19 were badged.

OTHER GOVERNMENT AGENCIES

Federal Civil Defense Agency (FCDA). A representative of this agency was badged at IVY. He was possibly an observer.

U.S. Coast and Geodetic Survey (USCGS). USCGS participated in pre-MIKE geological surveys of the atoll (Program 11). No representatives were badged.

U.S. Coast Guard. One officer and eight enlisted men at Enewetak ran a Loran station there. They were an administrative part of Task Group (TG) 132.2 and were evacuated for the MIKE shot with TG 132.2. None were badged.

Other Government Officials (VIP). One member of Congress was badged at IVY, as was also a member of the President's Cabinet.

CONTRACTORS AND OTHER ORGANIZATIONS

Allied Research Associates (ARA), Boston Massachusetts. Plans called for three employees of this firm to assist the Air Force in the conduct of Project 6.10. One was badged.

American Car and Foundry Company (ACF), Buffalo, New York. ACF fabricated and assembled the mechanical portions of the MIKE device.

American Red Cross. This organization had a representative at Enewetak who was badged with zero exposure.

Bendix Aviation, Burbank, California. This firm was to provide eight engineers to support the telemetry system for Project 6.11.

Boeing Airplane Company, Seattle, Washington. This Air Force contractor was to have a representative to aid in the effects aircraft experiments, but he was not badged.

Cambridge Corporation, Boulder, Colorado. This A.D. Little subsidiary was an AEC contractor.

Consolidated Vultee Air Corporation, San Diego, California. This Air Force contractor was to have a representative to aid in the effects aircraft experiments. Like the Boeing representative, he does not appear on the Consolidated List.

Edgerton, Germeshausen & Grier (EG&G), Boston, Massachusetts. This AEC contractor provided timing and firing and photographic services to the AEC, primarily in TG 132.1, Program 3.

Holmes and Narver, Inc. (H&N), Los Angeles, California. H&N, an architect and engineer firm, was the AEC contractor for the base support of the proving ground.

Holter Research Foundation, Helena, Montana. This organization provided one man who worked in Program 6. He was at Bikini during the MIKE shot.

Herrick L. Johnston, Inc. (HLJ), Columbus, Ohio. This was an AEC contractor.

Glenn L. Martin Company, Baltimore, Maryland. Eight engineers from this Air Force contractor were scheduled to aid in the conduct of the Kwajalein-based aircraft effects experiments.

Tracer Laboratory, Boston, Massachusetts.

University of California, Los Angeles (UCLA). UCLA was to provide eight men to aid in the thermal instrumentation of the aircraft used in the effects

experiments. One aided in Program 6 on the MV Horizon, but because his affiliation is garbled it is not possible to be sure that he is not from the University of California Berkeley campus. This man was also badged.

University of Washington, Applied Fisheries Laboratory (AFL). This organization manned Project 11.5.

CHAPTER 10

SUMMARY OF PERSONNEL EXPOSURES

Task force personnel exposed to nuclear radiation during the IVY test series were primarily involved in operations such as radioactive cloud sampling and data recovery where exposures were expected to occur. Only low-level widespread exposure of support personnel appears to have occurred.

Very few men exceeded the task force maximum permissible exposure (MPE) of 3.9 R. Those that significantly exceeded this limit were involved in two aircraft incidents.

The first (and the one resulting in the highest exposures recorded) involved the crew of an SA-16 search and rescue amphibious aircraft that was responding to an emergency situation. A sampler aircraft and its pilot went down following MIKE. The search and rescue aircraft took the shortest path to the downed aircraft and in so doing knowingly passed through a fallout zone. As a result, the 7-man crew received exposures of 10 to 17.8 R.

The second group of overexposures was the 12-man crew of a C-54 photo aircraft; the crewmembers received exposures ranging from 8.6 to 11.6 R. This aircraft was on a mission to take aerial pictures of the MIKE crater and was caught in fallout.

In both incidents corrective measures were taken to the extent possible, i.e., early ending of the mission, early return to base for decontamination, and flying through available rainshowers to aid in decontamination on the return flight.

A secondary low-intensity-level fallout followed MIKE and an even lower-intensity-level secondary fallout followed KING. The radioactive material exposed some task force personnel as it decayed.

The cumulative exposure dose from the material has been estimated for personnel on the basis of being left undisturbed by wind, rain, or washdown

activities and uniform distribution on a smooth, infinitely large plane. The subject of the irradiation was assumed to be fixed on this plane without any shielding from buildings or other structures (Reference D.4). The estimate shown graphically in Figure 28 increases rapidly as the MIKE fallout is deposited, then increases more slowly as it decays, but is slightly incremented with the arrival of the KING fallout, and again very slowly grows until by the end of 1952, when the increase in exposure is practically at an end. The values of Figure 28 are shown as a broad band to indicate how the maximum would vary depending on assumptions as to intensity of the radiation, which in turn could possibly vary, depending upon which of the Enewetak base islands were involved. The band represents only variations in the theoretical maximum, not the range from minimum to maximum.

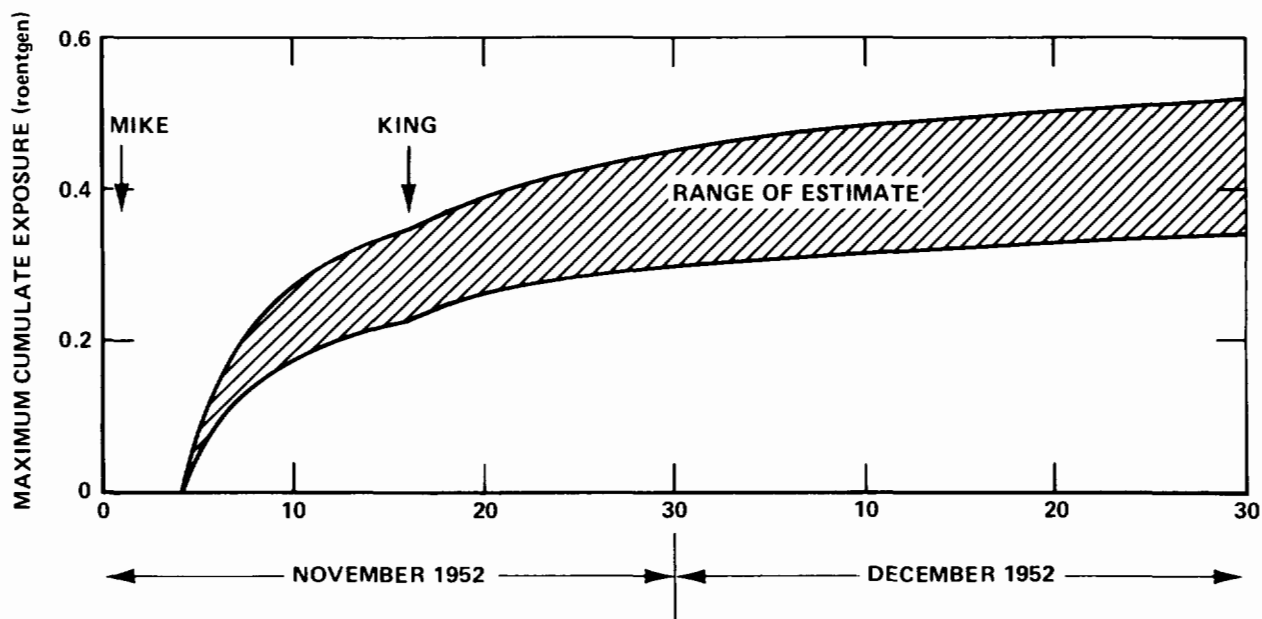

Figure 28. Estimate of IVY maximum exposure due to secondary fallout with no shielding and no weathering at Enewetak base islands (source: Reference D.4).

This dose reconstruction represents an attempt to construct an upper bound on the possible exposure of the TG 132.2 personnel permanently stationed at Enewetak. It should not be used for TG 132.4 personnel, nearly all of whom were stationed at Kwajalein, and, of course, it would only apply to TG 132.1 personnel for the periods they were at Enewetak. It would only apply to TG 132.3 personnel as long as their ships approximated the uniformly contaminated,

infinite-flat-plane approximation and the considerable shielding provided by deckhouses and hulls was ignored.

Summary statistics in Tables 35 and 36 present the exposures by service and by task force component. Averages (arithmetic means) have been derived from the records to simplify the exposure presentation. Three points, however, should be noted:

1. Film badges would not have completely recorded the contribution of the low-level, secondary fallout discussed above. They were issued and worn for only a few hours each, but the fallout radiation required days to accumulate recordable amounts. In this respect the exposures extracted from Figure 28 can be considered as an amount that can be added to the statistics in Tables 34 and 35. However, reductions would be required, reflecting the actual time a man was at the Pacific Proving Ground (PPG); what natural decontamination (such as rain leaching fallout particles into the soil) and deliberate decontamination (such as washing particles off buildings and ships) took place in his environment; and the shielding effect of his environment including buildings, ship hulls, and topographic irregularities.
2. It is not appropriate to extend the average derived from the badged personnel to the nearly 12,000 men of the task force. Exposures recorded by these badges are not typical examples. The majority of the badges appear from the record to have been issued to the people who were expected to be exposed to radiation.
3. This arithmetic mean was derived using the common statistical technique of assuming that the exposures within any of the intervals used were such that the midpoint of that interval could be used to calculate its contribution to the whole. This was done instead of summing the individual readings within each interval. In IVY it appears that the lowest-interval values (0.001 to 0.5 R) are heavily weighted to the near-zero side; therefore, the contribution to the whole of this interval is probably overestimated by assuming that an exposure of 0.25 R characterizes the interval. The average derived from this technique may have raised the average that would be derived using the individual values.

Table 35. Summary of IVY personnel exposure by service.

	Number of Men	Mean Exposure ^a (R)
Army and Army organization civilians		
Task Group 132.1	49	1.08
Task Group 132.2	106	0.34
Other Army	9	0.16
Total Army	164	0.55
Navy and Navy laboratory civilians		
Task Group 132.1	84	0.74
Task Group 132.2	1	0.25
Task Group 132.3	710	0.19
Other Navy	16	0.23
Total Navy	810	0.24
Air Force and Air Force laboratory civilians		
JTF 132	5	0.25
Task Group 132.1	32	1.01
Task Group 132.2	2	0.38
Task Group 132.4	624	0.61
Other Air Force	12	0.25
Total Air Force	675	0.62
Marine Corps		
Task Group 132.1	4	1.62
Task Group 132.3	10	1.05
Total Marine Corps	14	1.21
Joint Department of Defense agencies	3	1.7

Note:

^aDerived by summing the midpoint of each interval and weighting by number of personnel in each interval.

Table 36. Summary of IVY personnel exposure by task force organization.

	Number of Men	Mean Exposure ^a (R)
JTF 132 staff	5	0.25
Task Group 132.1	172	0.92
Task Group 132.2	108	0.33
Task Group 132.3	720	0.19
Task Group 132.4	624	0.61
Unidentified by task group	37	0.23
AEC and contractors (largely TG 132.1)	<u>364</u>	<u>0.62</u>
	2,030	0.47

Note:

^aDerived by summing the midpoint of each exposure interval.

BIBLIOGRAPHY AND REFERENCES

The sources consulted for this report are listed below. They are organized into sections based upon their relationship to the body of nuclear testing information.

The first section (A) contains basic references pertinent to nuclear weapons development and effects and to all or several atmospheric nuclear tests. These are generally monographs published and distributed through regular trade channels and are available in bookstores and libraries with the exceptions noted.

The second and third sections are documents generated by Joint Task Force 132 (JTF 132) and its subordinate organizations. The second section (B) contains planning documents for IVY, and the third (C) after-action reports. These JTF 132 references are arranged in a fashion that reflects the JTF 132 organization.

The fourth section (D) lists other reports by non-task-force organizations concerning IVY.

An availability code appears at the end of many reference citations for those who wish to read or obtain copies. Availability status was correct at the time the reference list was prepared. Many documents indicated as unavailable will become available during the declassification review process. The Department of Energy Coordination and Information Center (DOE CIC) and NTIS will be provided future DNA-WT documents bearing an "EX" after the report number.

Source documents with an availability code of DOE CIC may be reviewed at the following address:

Department of Energy
Coordination and Information Center
(Operated by Reynolds Electrical & Engineering Co., Inc)
ATTN: Mr. Richard V. Nutley
2753 S. Highland
P.O. Box 14100
Las Vegas, Nevada 89114
Telephone: (702) 734-3194; FTS: 598-3194.

Source documents bearing an NTIS availability code may be purchased at the following address:

National Technical Information Service
(Sales Office)
5285 Port Royal Road
Springfield, Virginia 22161
Telephone: (703) 787-4650.

- A.6 Environmental Radioactivity, Second Edition
M. Eisenbud
Academic Press, New York
1973
- A.7 Radiological Safety Regulation
NavMed P-1325
1951
- A.8 History of Fallout Prediction
J.C. Willis
School of Engineering, Air Force Institute of Technology
1 June 1977
NTIS (A03/MF A01) AD 079 560*

IVY PLANNING DOCUMENTS

- B.01 Control Book, Book 4***
Joint Task Force 132
September 1952
- B.02 Operation Plan 2-52***
Hq JTF 132
10 May 1952
- B.03 Operation Order 1-51***
Hq JTF 132
26 November 1951
- B.04 Operation Order 1-52***
Hq JTF 132
20 February 1952
- B.05 Operational Directive No. 1 (MIKE Event)***
Hq JTF 132
19 October 1952
- B.06 Operational Directive No. 3 (KING Event)***
Hq JTF 132
7 November 1952
- B.07 Emergency Evacuation Plan***
Hq JTF 132
10 November 1952

*Available from NTIS; order number appears before the asterisk.

**Available at DOE CIC.

***Not available.

- B.1.1 The Turquoise Book: Operation IVY***
P.G. Galletine Jr., Maj USAF, R.E. Keegan, Maj USAF, M.D. Sprinkel,
Capt USAF
15 May 1952
- B.1.2 Task Group 132.1 Operations, Rad-Safe Summaries***
Task Unit 7, Task Group 132.1
- B.3.1 Task Group 132.3 Operation Plan 1-52***
Commander Task Group 132.3
6 June 1952
- B.3.2 Task Group 132.3 Operation Order 2-52***
Commander Task Group 132.3
May 1952
- B.3.3 Task Group 132.3 Operation Order 2-52***
Commander Task Group 132.3
29 October 1952
- B.3.4 Task Group 132.3 Operation Order 3-52***
Commander Task Group 132.3
7 November 1952
- B.3.5 Operation Schedule No. 1-52***
Commander Task Element 132.33
25 October 1952
- B.4.1 Operations Plan 1-52***
Commander Task Group 132.4
16 June 1952
- B.4.2 Operations Order 2-52***
Commander Task Group 132.4
13 October 1952
- B.4.3 Operations Order 3-52***
Commander Task Group 132.4
24 October 1952
- B.4.4 Operations Order 4-52***
Commander Task Group 132.4
6 November 1952
- B.4.5 Operations Order 5-52***
Commander Task Group 132.4
10 November 1952

*Available from NTIS; order number appears before the asterisk.

**Available at DOE CIC.

***Not available.

- B.4.6 Operations Order 1-52***
Weather Recon Element
11 November 1952
- B.4.7 Operations Order 1-52***
Test Aircraft Unit
1 August 1942
- B.4.8 Operations Order 3-52, Flight "A"****
Test Aircraft Unit
28 October 1952
- B.4.9 Pilot Protective Clothing Conference***
Memo for record
JTF 132
21 August 1952

IVY POST-OPERATIONAL DOCUMENTS

- C.0.1 History of Operation IVY***
Maj F.E. Moore, Jr., Lt H.G. Bechanan
Joint Task Force 132
- C.0.2 Final Report by the Commander Joint Task Force 132, to the Joint Chiefs of Staff and Chairman, Atomic Energy Commission on Armed Forces Participation in the 1952 Nuclear and Thermonuclear Experimental Weapon and Device Tests***
Commander Joint Task Force 132
9 January 1952
- C.1.1 Report of the Commander, Task Group 132.1***
S.W. Burris
Los Alamos Scientific Laboratory
November 1952 WT-608
- C.1.2 History--Task Group 132.1***
Initial installment to 15 Jan 1952
1 Mar to 30 Apr 1952
1 May to 30 Jun 1952
1 Sep to 31 Oct 1952
Participation in MIKE Shot
Participation in KING Shot
Maj A.S. Knauf
Joint Task Force 132.1
Dates as indicated

*Available from NTIS; order number appears before the asterisk.

**Available at DOE CIC.

***Not available.

- C.1.3 Personal Recollection
W. Ogle to R. Miller
15 August 1980
- C.1.3.602 Air Shock Pressure-Time versus Distance***
G.W. Rollasson
Sandia Corporation
April 1953 WT-602
- C.1.3.603 Shock Winds, After-Winds, and Changes in air Temperature Resulting from Large Atomic Bursts Near the Earth's Surface***
Maynard Cowan
Sandia Corporation
May 1953 WT-603
- C.1.3.604 High-Resolution Spectroscopy at IVY Compared with Previous Tests***
C.A. Beck
Naval Research Laboratory
February 1955 WT-604
- C.1.3.605 Underwater Pressure Measurements in the Lagoon
G.W. Rollasson
Sandia Corporation
April 1953 WT-605
NTIS (A02/MF A01) AD 341 048*
- C.1.3.607 Profiling of the Ocean Site of Eniwetok Reef
Navy Hydrographic Office
May 1952 WT-607
- C.1.3.608 See C.1.1
- C.1.3.609 See C.1.10.1
- C.1.3.610 Measurement of Material Density with Beta Densitometer***
P.R. FlorCruz et al.
Los Alamos Scientific Laboratory
February 1953 WT-610
- C.1.3.611 Water-Wave Motion Pictures over Shallow Water***
W.D. Baker
Los Alamos Scientific Laboratory
February 1953 WT-611
- C.1.3.612 See C.1.9.1

*Available from NTIS; order number appears before the asterisk.

**Available at DOE CIC.

***Not available.

- C.1.3.613 Peak Overpressure Versus Distance in Free Air***
 J.F. Moulton, Jr., P. Hanlon
 Naval Ordnance Laboratory
 March 1953 WT-613
- C.1.3.614 See C.1.7.1
- C.1.3.615 Nature, Intensity, and Distribution of Fall-out From MIKE Shot***
 W.B. Heidt, Jr., E.A. Schuert, W.W. Perkins, R.L. Stetson
 Naval Radiological Defense Laboratory
 April 1953 WT-615
- C.1.3.616 Radiobiological Studies at Eniwetok Before and After MIKE Shot***
 L.R. Donaldson
 Applied Fisheries Laboratory, University of Washington
 June 1953 WT-616
- C.1.3.617 Fall-out and Cloud Particle Studies***
 Army Chemical Corps Engineering Command
 December 1953 WT-617
- C.1.3.620 Measurements of Reaction History, Vol I***
 E.H. Krause
 Naval Research Laboratory
 June 1953 WT-620
- C.1.3.621 Measurements of Reaction History, Vol II***
 E.H. Krause
 Naval Research Laboratory
 June 1953 WT-621
- C.1.3.622 Measurements of Reaction History, Vol III***
 E.H. Krause
 Naval Research Laboratory
 June 1953 WT-622
- C.1.3.623 Measurements of Reaction History, Vol IV***
 E.H. Krause
 Naval Research Laboratory
 June 1953 WT-623
- C.1.3.624 Measurements of Reaction History, Vol V***
 E.H. Krause
 Naval Research Laboratory
 June 1953 WT-624

*Available from NTIS; order number appears before the asterisk.

**Available at DOE CIC.

***Not available.

- C.1.3.625 Measurement of Reaction History, Vol. VI***
E.H. Krause
Naval Research Laboratory
June 1953 WT-625
- C.1.3.627 Blast-Wave Mass-Motion Measurements***
D.F. Seacord
Los Alamos Scientific Laboratory
June 1953 WT-627
- C.1.3.629 Pressure-Time Measurements in Deep Water***
W.J. Thaler
Office of Naval Research
January 1953 WT-629
- C.1.3.630 Heavy Nuclides in Bomb Debris***
C.I. Browne
Los Alamos Scientific Laboratory
March 1953 WT-630
- C.1.3.631 Free Air Atomic Blast Pressure and Thermal Measurements
N.A. Haskell, et al.
Air Force Cambridge Research Center
August 1963 WT-631
NTIS (A04/MF A01) AD 363 575/2*
- C.1.3.632 Detection of Airborne Low-Frequency Sound from Nuclear Explosions***
G.B. Olmsted
Hq USAF
November 1952 WT-632
- C.1.3.633 Underwater Pressures of Seismic Waves***
R.W. Raitt
Scripps Institution of Oceanography, University of California
October 1953 WT-633
- C.1.3.634 Gamma Radiation Versus Time***
J.S. Malik
Los Alamos Scientific Laboratory
February 1954 WT-634
- C.1.3.636 Personnel and Administration***
A.W. Kelly
Los Alamos Scientific Laboratory
January 1954 WT-636

*Available from NTIS; order number appears before the asterisk.

**Available at DOE CIC.

***Not available.

- C.1.3.637 Photoelectric Study of Teller Light***
R.L. Nadeau, J.M. Yandle
Naval Research Laboratory
February 1954 WT-637
- C.1.3.639 Technical Photography***
Edgerton, Germeshausen & Grier
July 1954 WT-639
- C.1.3.641 Damage Survey and Analysis of Structures***
J.S. Acher, E.A. Lawlor
Massachusetts Institute of Technology
June 1954 WT-641
- C.1.3.642 Effects of Atomic Explosions on the Ionosphere
Army Signal Corps Engineering Laboratories
March 1955 WT-642
NTIS (A04/MF A01) AD 363 391*
- C.1.3.643 Gamma Radiation as a Function of Distance***
E. Storm
Los Alamos Scientific Laboratory
July 1955 WT-643
- C.1.3.644 Electromagnetic Effects from Nuclear Explosions***
M.H. Oleson
Hq USAF
January 1958 WT-644
- C.1.3.645 Radiochemical and Physical Analysis of Atomic Debris***
W. Singlevich, C.K. Reed
Hq USAF
November 1952 WT-645
- C.1.3.646 Detection of Fireball Light at Distances***
M.H. Oleson
Hq USAF
November 1952 WT-646
- C.1.3.647 Dispersion of Gaseous Debris from Nuclear Explosions***
P.W. Allen
Hq USAF
March 1958 WT-647
- C.1.3.648 Radio-Frequency Characteristics of Electromagnetic Radiation***
Evans Signal Laboratory, Physical Sciences Division
July 1958

*Available from NTIS; order number appears before the asterisk.

**Available at DOE CIC.

***Not available.

- C.1.3.649 Fall-Out Gamma Ray Intensity
M.P. Klein
University of California Radiation Laboratory
January 1958 WT-649
NTIS (PC A02/MF A01) AD 467 226/7*
- C.1.3.9003 Ground-Motion Studies on Operations IVY and CASTLE
W.R. Perret
Sandia Corporation
February 1955 WT-9003-EX
NTIS (PC A04/ AD A995 143/5*
- C.1.7.1 Radiological Safety
R.H. Maynard, J.D. Servis
JTF 132
January 1953 WT-614
NTIS (PC A06/MF A01) AD 363 620/6*
- C.1.7.2 Consolidated List of Exposures to Radiation of Personnel Participating in Operation IVY***
JTF 132, Task Group 7, Task Unit 7 (Radsafe)
20 November 1952
- C.1.7.3 Personnel Radiation Exposure Record--Microfilm***
(microfilm of 5x8 cards from which IPO 132.1TU7#2 was probably derived)
1952
- C.1.7.4 Personal Recollection***
G.C. Facer to M.J. Osborne and E. Martin
13 November 1980 and 11 March 1981
- C.1.7.5 Personal Recollections***
J. Service, Albuquerque, New Mexico
April 1981
- C.1.7.6 Personal Recollection***
Payne Harris
April 1981
- C.1.9.1 Documentary Photography***
J.L. Gaylord
Lookout Mountain Laboratory
February 1953 WT-612

*Available from NTIS; order number appears before the asterisk.

**Available at DOE CIC.

***Not available.

- C.10.1 Timing and Firing and Fiducial Markers***
H.E. Grier
Edgerton, Germeshausen and Grier, Inc.
March 1953 WT-609
- C.2.1 Final Report by the Commander, Task Group 132.3 to the Commander, Joint Task Force 132 on the Participation of Task Group 132.2 in Operation IVY***
- C.2.2 Task Group 132.2 History***
- C.2.3 Unit History, Task Group 132.2, Joint Task Force 132***
1 Jun 1951-31 Oct 51, Nine Installments
- C.3.1 Task Group 132.3 History***
December 1952
- C.3.2 Final Report Operation IVY***
Task Group 132.3, Joint Task Force 132
4 December 1952
- C.3.3 Summary of Activities from 31 October to Det 3***
Commander Task Element 132.3
3 December 1952
- C.3.4 Operational Report***
Commanding Officer Oak Hill (LSD-7)
28 November 1952
- C.3.5 Boat Pool Operations -- IVY***
Commander Task Element 132.32
4 December 1952
- C.3.6 Report on Office of Naval Research-Scripps Participation***
ONR-Scripps Institution of Oceanography
7 December 1952
- C.3.7 Future Operations Similar to IVY***
CTG 132.3 to Chief, BuShips
- C.3.8 Ships Logs (various ships logs cited as Ships Name Log)***
1952
- C.3.9 Post Operation Report***
Commanding Officer, Carpenter (DDE-825)
20 November 1952

*Available from NTIS; order number appears before the asterisk.

**Available at DOE CIC.

***Not available.

- C.3.10 Summary of Operations***
 Commanding Officer, Rendova (CVE-114)
 8 December 1952

- C.3.11 Roll-Up Phase Report***
 Commanding Officer, Rendova (CVE-114)
 20 November 1953

- C.3.12 Helicopter Operations, 3 October to 18 November 1952 and 1st En-
 endorsement (Commanding Officer, Rendova)***
 Officer in Charge

- C.3.13 Radiological Decontamination of Helicopters***
 Officer in Charge Helicopter Detachment
 13 November 1952

- C.3.14 AU-Weather Fighter Operations 2 October through 15 November 1952
 and 1st Endorsement (Commanding Officer, Rendova)***
 Officer in Charge

- C.3.15 Utility Flight Operations from 2 October through 16 November 1952
 and 1st Endorsement (Commanding Officer, Rendova)***
 Officer in Charge

- C.3.16 Report of Deployed Operations***
 Commanding Officer, Patrol Two (VP-2)
 1 January 1953

- C.4.1 Final Report, Task Group 132.4, Jan-Dec 1952***
 Hq TG 132.4
 1952

- C.4.2 Command and Statistical Summary, Task Group 132.4***
 TG 132.4

- C.4.3 The Monthly Historical Report***
 HQ TG 132.4
 November 1952

*Available from NTIS; order number appears before the asterisk.

**Available at DOE CIC.

***Not available.

- C.4.4 Narrative History of TG 132.4 Provisional***
 1 Jul 1951-29 Feb 1952
 1 Mar 1952-30 Apr 1952
 1 May 1952-30 Jun 1952
 1 Jul 1952-31 Aug 1952
 1 Sep 1952-31 Oct 1952
 Special Installment (History) MIKE
 Special Installment (History) KING
 TG 132.4
 16 Oct-31 Dec 1952
- C.4.5 Final Mission Report (Letter)***
 TG 132.4 Test Aircraft Unit
 16 December 1952
- C.4.6 Historical Report***
 May-June 1952
 1 Jul-25 Aug 1952
 26 Aug-15 Oct 1952
 TG 132.4 Test Aircraft Unit
- C.4.7 History of the Test Services Unit***
 Feb 1952
 1 Mar-15 Apr 1952
 16 Apr-30 Jun 1952
 1 Jul-25 Aug 1952
 26 Aug-15 Oct 1952
 Historical Div MATS
- C.4.8 History of the Weather Reconnaissance Element***
 1 Jan-30 Jun 1952
 1 Jul-25 Aug 1952
 26 Aug-15 Oct 1952
 57th Strategic Recon Sq
- C.4.9 Narrative Report, WREP Participation***
 TG 132.4 WREP
 n.d.
- C.4.10 History of the Weather Reporting Element Provisional***
 1 Mar-30 Apr 1952
 1 Jul-25 Aug 1952
 26 Aug-15 Oct 1952
 16 Oct-10 Dec 1952
 Hq Weather Reporting Element Provisional

*Available from NTIS; order number appears before the asterisk.

**Available at DOE CIC.

***Not available.

- C.4.11 Historical Report of the Search and Rescue Element Provisional***
Hq Search and Rescue Element
1 July 1952

OTHER AFTER-ACTION DOCUMENTS

- D.1 Radioactive Debris from Operation IVY***
New York Operations Office, USAEC
28 April 1953 NYO 4522
- D.2 History of Operation Greenhouse 1948-51, Vol I
Lt Gen E.R. Quesada, CJTF 3 WT-47
NTIS AD 740 867*
- D.3 "The Debate Over the Hydrogen Bomb," Scientific American, vol 233,
no. 4
H.F. York
October 1975
- D.4 Memo: Calculated Radiation Doses for Personnel in Task Group 132.2,
Joint Task Force 132, During Operation IVY***
R. Gminder, Science Applications, Inc.
March 1981

*Available from NTIS; order number appears before the asterisk.

**Available at DOE CIC.

***Not available.

APPENDIX A
ISLAND SYNONYMS
ENEWETAK ATOLL

CAPITALIZED entries are the code names used by the joint task force for the islands. Underscored entries are the names of the islands as used in this report. All other entries are spellings of the islands that may appear in other literature.

Aaraanbiru	VERA - <u>Alembel</u> - Arambiru
<u>Aej</u>	OLIVE - Aitsu
Aitsu	OLIVE - <u>Aej</u>
<u>Alembel</u>	VERA - Aaraanbiru - Arambiru
ALICE	<u>Bokoluo</u> - Bogallua
ALVIN	<u>Jinedrol</u> - Chinieero
<u>Ananij</u>	BRUCE - Aniyaanii
Anerowij	TOM - <u>Munjor</u> - Munjur
Aniyaanii	BRUCE - <u>Ananij</u>
<u>Aomon</u>	SALLY
Arambiru	VERA - <u>Alembel</u> - Aaraanbiru
BELLE	<u>Bokombako</u> - Bogombogo
Biijiri	TILDA - <u>Bijire</u> - Bijile - Bikile
Bijile	TILDA - <u>Bijire</u> - Biijiri - Bikile
<u>Bijire</u>	TILDA - Bijile - Biijiri - Bikile
<u>Biken</u>	LEROY - Rigile - Rigili
Bikile	TILDA - <u>Bijire</u> - Bijile - Biijiri
<u>Billae</u>	WILMA - Piirai - Piirai
Billee	LUCY - <u>Kidrinen</u> - Kirinian
Bogairikk	HELEN - <u>Bokaidrikdrik</u> - Bogeirik - Bokaidrik
Bogallua	ALICE - <u>Bokoluo</u>
Bogan	IRWIN - <u>Boken</u> - Pokon
Bogeirik	HELEN - <u>Bokaidrikdrik</u> - Bogairikk - Bokaidrik
Bogen	REX - <u>Jedrol</u> - Jieroru
Bogombogo	BELLE - <u>Bokombako</u>
Bogon	IRENE - <u>Boken</u>
Bokaidrik	HELEN - <u>Bokaidrikdrik</u> - Bogairikk - Bogeirik
<u>Bokaidrikdrik</u>	HELEN - Bogairikk - Bogeirik - Bokaidrik
<u>Bokandretok</u>	WALT
<u>Boken</u>	IRENE - Bogon
<u>Boken</u>	IRWIN - Pokon - Bogan
<u>Bokenelab</u>	MARY - Bokonaarappu - Bokonarppu
<u>Bokinwotme</u>	EDNA - Sanildefonso
<u>Boko</u>	SAM
<u>Bokoluo</u>	ALICE - Bogallua
<u>Bokombako</u>	BELLE - Bogombogo
Bokonaarappu	MARY - <u>Bokenelab</u> - Bokonarppu
Bokonarppu	MARY - <u>Bokenelab</u> - Bokonaarappu
BRUCE	<u>Ananij</u> - Aniyaanii
Buganegan	HENRY - <u>Mut</u> - Mui

Chinieero	<u>ALVIN</u> - <u>Jinedrol</u>
Chinimi	<u>CLYDE</u> - <u>Jinimi</u>
CLARA	<u>Kirunu</u> - Eybbiyae - Ruchi
CLYDE	<u>Jinimi</u> - Chinimi
Cochita	<u>DAISY</u> - <u>Louj</u> - Lidilbut
DAISY	<u>Louj</u> - Cochita - Lidilbut
DAVID	<u>Japtan</u> - Muti
<u>Drekatimon</u>	OSCAR
<u>Dridrilbwi</u>	<u>GENE</u> - Teiteiripucchi
Eberiru	<u>RUBY</u> - <u>Eleleron</u>
EDNA	<u>Bokinwotme</u> - Sanildefonso
<u>Eleleron</u>	<u>RUBY</u> - Eberiru
<u>Elle</u>	<u>NANCY</u> - Yeiri
<u>ELMER</u>	<u>Parry</u> - Medren
Elugelab	<u>FLORA</u> - <u>Eluklab</u>
<u>Eluklab</u>	<u>FLORA</u> - Elugelab
<u>Enewetak</u>	<u>FRED</u> - Eniwetok
Engebi	<u>JANET</u> - <u>Enjebi</u>
Eniwetok	<u>FRED</u> - <u>Enewetak</u>
<u>Enjebi</u>	<u>JANET</u> - Engebi
Eybbiyae	<u>CLARA</u> - <u>Kirunu</u> - Ruchi
FLORA	<u>Eluklab</u> - Elugelab
FRED	<u>Enewetak</u> - Eniwetok
GENE	<u>Dridrilbwi</u> - Teiteiripucchi
Giriinien	<u>KEITH</u> - <u>Kidrenen</u> - Grinem
GLENN	<u>Ikuren</u> - Igurin
Grinem	<u>KEITH</u> - <u>Kidrenen</u> - Giriinien
HELEN	<u>Bokaidrikdrik</u> - Bogairikk - Bogeirik - Bokaidrik
HENRY	<u>Mut</u> - Buanegan - Mui
Igurin	<u>GLENN</u> - <u>Ikuren</u>
<u>Ikuren</u>	<u>GLENN</u> - Igurin
<u>Inedral</u>	URIAH
IRENE	<u>Boken</u> - Bogon
IRWIN	<u>Boken</u> - Bogan - Pokon
JAMES	<u>Ribewon</u> - Libiron - Ribaion
JANET	<u>Enjebi</u> - Engebi
<u>Japtan</u>	DAVID - Muti
<u>Jedrol</u>	REX - Jieroru - Bogen
Jieroru	REX - <u>Jedrol</u> - Bogen
<u>Jinedrol</u>	ALVIN - Chinieero
<u>Jinimi</u>	CLYDE - Chinimi
KATE	<u>Mijikadrek</u> - Mujinkarikku - Muzinbaarikku
KEITH	<u>Kidrenen</u> - Giriinien - Grinem
<u>Kidrenen</u>	<u>KEITH</u> - Giriinien - Grinem

<u>Kidrinen</u>	LUCY - Billee - Kirinian
<u>Kirinian</u>	LUCY - <u>Kidrinen</u> - Billee
<u>Kirunu</u>	CLARA - <u>Eybbiyae</u> - Ruchi
LEROY	<u>Biken</u> - Rigile - Rigili
Libiron	JAMES - <u>Ribewon</u> - Ribaion
Lidilbut	DAISY - <u>Louj</u> - Cochita
<u>Lojwa</u>	URSULA - <u>Rojoa</u>
<u>Louj</u>	DAISY - Cochita - Lidilbut
LUCY	<u>Kidrinen</u> - Billee - Kirinian
<u>Lujor</u>	PEARL - <u>Rujiyoru</u> - Rujoru
MACK	<u>Unibor</u>
MARY	<u>Bokenelab</u> - Bokonaarappu - Bokonarppu
Medren	ELMER - <u>Parry</u>
<u>Mijikadrek</u>	KATE - <u>Mujinkarikku</u> - Muzinbaarikku
Mui	HENRY - <u>Mut</u> - Buganegan
Mujinkarikku	KATE - <u>Mijikadrek</u> - Muzinbaarikku
<u>Munjor</u>	TOM - <u>Anerowij</u> - Munjur
Munjur	TOM - <u>Munjor</u> - Anerowij
<u>Mut</u>	HENRY - Buganegan - Mui
Muti	DAVID - <u>Japtan</u>
Muzinbaarikku	KATE - <u>Mijikadrek</u> - Mujinkarikku
NANCY	<u>Elle</u> - Yeiri
OLIVE	<u>Aej</u> - Aitsu
OSCAR	<u>Drekatimon</u>
<u>Parry</u>	ELMER - Medren
PEARL	<u>Lujor</u> - <u>Rujiyoru</u> - Rujoru
PERCY	<u>Taiwel</u>
Piiraai	WILMA - <u>Billae</u> - Piirai
Piirai	WILMA - <u>Billae</u> - Piiraai
Pokon	IRWIN - <u>Boken</u> - Bogan
REX	<u>Jedrol</u> - Bogen - Jieroru
Ribaion	JAMES - <u>Ribewon</u> - Libiron
<u>Ribewon</u>	JAMES - <u>Libiron</u> - Ribaion
Rigile	LEROY - <u>Biken</u> - Rigili
Rigili	LEROY - <u>Biken</u> - Rigile
Rojoa	URSULA - <u>Lojwa</u>
RUBY	<u>Eleleron</u> - Eberiru
Ruchi	CLARA - <u>Kirunu</u> - <u>Eybbiyae</u>
Rujiyoru	PEARL - <u>Lujor</u> - Rujoru
Rujoru	PEARL - <u>Lujor</u> - Rujiyoru
<u>Runit</u>	YVONNE
SALLY	<u>Aomon</u>
SAM	<u>Boko</u>
Sanildefonso	EDNA - <u>Bokinwotme</u>

<u>Taiwel</u>	PERCY
Teiteiripucchi	GENE - <u>Dridrilbwi</u>
TILDA	<u>Bijire</u> - <u>Bijile</u> - <u>Bijiri</u> - <u>Bikile</u>
TOM	<u>Munjor</u> - <u>Anerowij</u> - <u>Munjur</u>
<u>Unibor</u>	MACK
URIAH	<u>Inedral</u>
URSULA	<u>Lojwa</u> - <u>Rojoa</u>
VAN	Enewetak Atoll
VERA	<u>Alembel</u> - <u>Aaraanbiru</u> - <u>Arambiru</u>
WALT	<u>Bokandretok</u>
WILMA	<u>Billae</u> - <u>Piirai</u> - <u>Piirai</u>
Yeiri	NANCY - <u>Elle</u>
YVONNE	<u>Runit</u>

APPENDIX B

RADIOLOGICAL SAFETY AND RELATED DOCUMENTS

RETYPE COPIES OF:

CJTF Operation Plan No. 2-52

Annex P -- Radiological Safety

Appendix I -- Hazards Resulting from Atomic
Bomb Explosions

Appendix II -- Special Radiological Safety Regulations

Appendix III -- Radiological Safety Center

Annex T -- Shot Phase Execution

Annex U -- Post-Shot Reentry Plan

Appendix I -- Reentry Following MIKE Shot

Appendix II -- Reentry Following KING Shot

Headquarters, Joint Task Force 132
WASHINGTON 25, D.C.
15 August 1952, 1800 R

Annex P to CJTF 132 Operation Plan No. 2-52

RADIOLOGICAL SAFETY

1. Primary Mission. The purpose of this radiological safety plan is to provide for:
 - a. The protection of civilian and military personnel of the Task Force from radiological hazards.
 - b. The maintenance of the operational efficiency of the Task Force in the presence of radiological hazards.
 - c. The training and organization of JTF 132 for radiological safety.
 - d. The collection and dissemination of radiological safety information.
 - e. Informing CINCPAC of radiological hazards which may exist to those living within a radius of 600 miles, or flying within a radius of 1000 miles of the test site.
2. General Terminology. Radiological Defense (RadDefense) operations, or Radiological Safety (RadSafe) operations, short term RADOPS, as used herein, are general terms. They are used to denote the means by which a unit can control and confine the damage and radiological effects of an atomic explosion, or of radioactive material spread by other means, thereby preventing and avoiding health hazards to personnel. They are interpreted to include measures such as (a) training, organization and distribution of radiological personnel, (b) development of techniques and procedures, including use of detecting equipment, protection or removal of exposed personnel, and decontamination of personnel, structures and equipment.

Following each detonation there will be areas of surface radiological contamination and areas of air radiological contamination. These areas are designated as Radiological Exclusion Areas (RADEX). Prior to shot times, the forecast surface RADEX will be disseminated by CJTF 132 in the target area, while CTG 132.4, at KWAJALEIN, disseminates the forecast air RADEX. These RADEXES will represent a forecast from HOW Hour (H-Hour) until dissemination of a later surface and air RADEX at about H plus 4 hours. The later RADEXES will be based upon the master radiological "situation map" maintained by CTG 132.1 aboard the flagship of CJTF 132. Since the air RADEX after shot time will be based on monitored air tracking by TG 132.4 aircraft over significant large ocean areas, information promulgated from the forecast air RADEX may have to be extended beyond the originally anticipated 4 hour period.

The surface RADEX will be determined by actual survey with Radiation Detection, Indication and Computation (RADIAC) equipment after shot time. The most rapid method of accomplishing surface survey in the early stages will be by helicopter flight in and around the surface of contaminated areas. From the radiation intensities measured at a known altitude, it is possible to obtain a rough estimate of the radiation dosage rates which would be encountered on the surface of the ground or water. Actual water samples from the lagoon will be utilized. Ground survey will follow this rough guide to determine definitely the contaminated regions and objects. Formal ground survey of the ENIWETOK ATOLL, as feasible, will be accomplished on M plus 1 Day.

3. Responsibilities

a. Command Responsibilities. Radiological safety and training of all military and civilian personnel is a command responsibility.

b. Commander, Joint Task Force 132. The Commander will:

(1) Specify the measures necessary to insure the radiological safety of Task Force personnel and furnish technical advisory assistance to task group radiological safety officers.

(2) Inform CINCPAC of radiological hazards which may exist to those living within a radius of 600 miles, or flying within a radius of 1,000 miles of the test site.

c. Commander, Task Group 132.1, having the major technical radiological safety unit, will:

(1) Perform all ground monitoring services associated with scientific missions, including monitoring of water supplies at inhabited distant atolls. The Commander, TG 132.3 will assist CTG 132.1 in furnishing this service.

(2) Furnish laboratory services and technical assistance to all task groups to include:

(a) Procurement, storage, and issued [sic] of film badges and specified supplementary items of personnel radiological safety equipment.

(b) Laboratory services to develop and interpret photo [film] badges.

(c) Maintenance of records of exposures from film badges (duplicates will be furnished to appropriate task groups).

(d) Provision of facilities at PARRY ISLAND radiological safety building for calibration, repair and maintenance of instruments, and issue and storage of spare parts for RADIAC equipment.

(e) Monitoring the removal and packaging of radioactive

sources and samples.

(3) Develop and furnish radiological safety surface situation maps after shot time to the Task Force Commander, and the task groups requiring the information.

(4) Procure radiological safety clothing as necessary for TG 132.1 and specified recovery personnel.

(5) Procure and issue special high density goggles to specified personnel of JTF 132.

(6) Provide technical personnel to inspect radiologically contaminated items for all task groups, and certify destruction or disposal to JTF 132.

(7) Provide personnel and equipment decontamination facilities.

(8) Conduct necessary fall-out and radiochemical studies for radiological safety documentation.

d. Commander, Task Group 132.2 will:

(1) Provide and train own radiological safety organization.

(2) Provide and maintain own RADIAC equipment and clothing.

(3) Provide limited contaminated clothing laundry facilities.

(4) Provide contaminated equipment storage area with the necessary security.

(5) Provide necessary military decontamination equipment.

(6) Assist CTG 132.1 in equipment decontamination operations.

e. Commander, Task Group 132.3 will:

(1) Insure that appropriate RADIAC equipment and qualified personnel are aboard each unit of the Task Group, and in required condition of readiness to carry out the radiological safety missions of the TG.

(2) It is desired to point out, however, that the employment of ships and units in TG 132.3, insofar as radiological safety is concerned, is not considered a routine employment under the conditions of atomic warfare. The peculiar requirements with embarked scientific civilian personnel, peacetime employment of the vessels in an atomic test and attendant special regulations governing personnel exposure under such circumstances are not generally amenable to tactical considerations.

(3) The special requirement of one airborne monitor for each

multi-engine aircraft crew is a firm requirement of Operation IVY. It is assumed that in conditions of readiness for radiological operations of any aircraft units this will be included.

(4) Provide own repair, spare parts and calibration facilities.

(5) While Task Force is embarked, provide space for a laboratory of limited facility for radiochemistry techniques, fall-out studies, photodosimetry developing, equipment storage, and administrative space for use by TG 132.1 radiological safety operations section.

(6) Provide decontamination facilities for own aircraft not based on KWAJALEIN.

(7) Provide necessary helicopter air service for immediate post-shot survey (monitors furnished by TG 132.1).

(8) Provide amphibious aircraft for assistance to TG 132.1 in monitoring of fall-out and collection of water samples from adjacent and distant inhabited islands/atolls.

f. Commander, Task Group 132.4 will:

(1) Provide and train own radiological safety monitors, including one (1) airborne monitor for each multi-engine aircraft crew assigned to TG 132.4

(2) Provide own RADIAC equipment and protective clothing.

(3) Provide own repair, spare parts and calibration facilities of RADIAC equipment for aircraft at KWAJALEIN ISLAND.

(4) Provide decontamination facilities for own aircraft and, by providing facilities and equipment, assist TG 132.3 in decontamination of TG 132.3 aircraft on KWAJALEIN (only decontamination equipment for stand-by utility is required at ENIWETOK).

(5) Provide cloud tracking airplanes for post-shot radiological safety "situation data" up to radius of 1000 miles in the significant quadrant, as designated by CJTF 132, for period of 48 hours after detonation.

(6) Prepare air RADEX.

(7) Provide facilities for personnel decontamination at KWAJALEIN.

g. All radiological safety operations for Operation IVY will be considered as routine and will comply with permissible radiological exposures for routine work, except "special" operations, which must be specifically designated by the CJTF 132. (See Appendix II).

h. In tactical situations the military commander must make the decision regarding allowable exposures. As military personnel are normally subject to only random exposures, health hazards are at a minimum. Current Department of Defense information on exposure to gamma radiation in tactical situations is indicated below:

(1) Uniform acute (immediate) dosage of 50 roentgens to a group of armed forces personnel will not appreciably affect their efficiency as a fighting unit.

(2) Uniform acute dosage of 100 roentgens will produce in occasional individuals nausea and vomiting, but not to an extent that will render armed forces personnel ineffective as fighting units. Personnel receiving an acute radiation dose of 100 or more roentgens should be given a period of rest and individual evaluation as soon as possible.

(3) Uniform acute dosage of approximately 150 roentgens, or greater, can be expected to render armed forces personnel ineffective as troops within a few hours through a substantial incidence of nausea, vomiting, weakness and prostration. Mortality produced by an acute dose of 150 roentgens will be very low and eventual recovery of physical fitness may be expected.

(4) Field commanders should, therefore, assume that if substantial numbers of their men receive acute radiation doses substantially above 100 roentgens, there is grave risk that their commands will rapidly become ineffective as fighting units. Cumulative radiation doses over the entire body of about 200 roentgens may substantially reduce the life expectancy of the irradiated individual.

(5) Internal radiation hazards caused by entry of radioactive substances through the mouth, through the lungs, or through cuts or wounds do not exist after an air burst. Internal hazards following a contaminating explosion may be avoided if ordinary precautions are taken. Only under unusual circumstances will there be an internal hazard from residual contamination. This eliminates the necessity for masking and consequent reduction of tactical efficiency.

4. Training. The inclusion of a radiological safety organization throughout the Task Force will require two general levels of training; basic indoctrination and technical training. The scope of instruction within each of these levels will vary in accordance with the requirements of different operational and staff levels.

Basic indoctrination will include primary, non-technical instruction in radiological safety measures and techniques. This must be imparted to all personnel of the Task Force to enable them to perform their assigned duties efficiently within the allowable low exposures, regardless of the presence of radioactive contaminants.

Technical training will include the training of the majority of the personnel who will be required to staff the Task Force radiological safety organization and perform the technical operations involved. This will be accomplished through the utilization of existing Service courses and establishment of suitable courses at task group level. This instruction will be designed to train radiological defense monitors, decontamination personnel and radiological instrument repairmen.

Commander [JTF-132]

Appendix

- I - Hazards Resulting from Atomic Bomb Explosions
- II - Special Radiological Safety Regulations
- III - Radiological Safety Center

OFFICIAL:

(signed)
Assistant Chief of Staff, J-3

Headquarters, Joint Task Force 132
WASHINGTON 25, D.C.
10 May 1952, 1800 R

Appendix I to Annex P
Radiological Safety, CJTF 132 Operation Plan No. 2-52

HAZARDS RESULTING FROM ATOMIC BOMB EXPLOSIONS

1. Nature of Hazards

- a. When an atomic bomb explosion occurs, tremendous quantities of energy in a variety of forms are released. This energy is propagated outward in all directions.
- b. When fission occurs, the immediate reaction is intense emission of ultraviolet, visible, and infrared (heat) radiation, gamma rays and neutrons. This is accompanied by the formation of a large ball of fire. A large part of the energy from the explosion is emitted as a shock wave. The ball of fire produces a mushroom-shaped mass of hot gases, the top of which rises rapidly. In the trail below the mushroom cap, a thin column is left. The cloud and column are then carried downwind, the direction and speed being determined by the direction and speed of the wind at the various levels of air from the surface to base of mushroom cap. At ENIWETOK, part of the energy from the explosion results in an ocean surface wave which is considered of minor nature directly to the Task Force.
- c. All personnel of the Task Force will be well outside of the range of all hazard at the time of detonation, except for the intense light from the fire ball.
- d. Following the detonation, personnel entering shot areas will be exposed to beta particles and gamma rays coming from induced neutron activity in the soil and any fission products which might have been deposited on the ground. There may also be a potential alpha particle hazard from the unfissioned fissionable materials which may be deposited on the ground.
- e. The light of explosion is so intense that permanent injury to the eye may result from viewing the ball of fire at close range with the naked eye or through binoculars. Ordinary dark glasses will not suffice and all personnel who do not have the special protective glasses, which will be issued in limited numbers by TG 132.1, must be facing 180 degrees from the detonation.
- f. The emission of dangerous nuclear radiation can be separated into two time periods. The primary radiation which occurs at the time of the flash is composed of gamma rays and neutrons. Casualties may result from this primary radiation if the exposure occurs within a certain range of ground zero. Secondary radiation is due to activation of the soil around ground zero and to fall-out.

1. Protection

- a. Against the primary radiological effects, distance will provide protection.
- b. Against the secondary radioactivity hazards from radioactive fission products, induced radioactivity and unfissioned residue, detection and avoidance provide the best protection. Suitable instruments indicate directly both the presence and intensity of radioactivity at a given place. Area reconnaissance, the maintenance of contamination situation maps, the posting of areas of hazard, and minimizing the spread of contaminated material into uncontaminated areas constitute the active measures for reducing the radiological hazard.
- c. Personnel within an operational radius of ground zero (details to be designated by dispatch) who are to be facing in the direction of the flash will be required to wear special goggles to protect their eyes against excessive light. Personnel within the above operational radius who are not provided goggles will face in the opposite direction from the flash. After ten (10) seconds, such personnel may do an about face and observe the phenomena.

3. Anticipated Hazard Areas

- a. Immediately under the bomb burst there will be an area of intense radioactivity.
- b. Extending downwind, an airborne radioactive hazard will exist. Its characteristics will depend on the meteorological influences such as wind speed and direction at various altitudes up to the maximum height reached by the cloud.
- c. Contaminated water in the lagoon adjacent to the shot island should be of minor consequence, but will be checked by the radiological safety unit of TG 132.1 immediately after shot time and at other intervals.
- d. Unless care is exercised, individuals or objects entering contaminated areas may transfer radioactivity to clean areas.
- e. By means of instruments, such as Geiger-Mueller counters and ion chambers, it is possible to detect the area of contamination and to measure the intensity of the radioactivity. Radiation intensity will normally be measured and reported in roentgens per hour. Besides those instruments, dosimeters and film badges will be used as indicators of the accumulated exposure to radioactivity. Only personnel involved in work near, or in, radioactive areas will wear film badges to provide a permanent record of exposure.
- f. The intensity of the radioactive hazard tends to decrease with time due to decay of radioactive materials, and dispersion and dilution, depending upon climatic conditions. As an approximation, the intensity of the radiation from the fission products decreases

by radioactive decay inversely with the time after the detonation.

4. This appendix is of reduced security classification in order to permit wide dissemination to all personnel of the command.

Commander [JTF 132]

OFFICIAL:

(signed)
Assistant Chief of Staff, J-3

Headquarters, Joint Task Force 132
WASHINGTON 25, D.C.
10 May 1952, 1800 R

Appendix II to Annex P
Radiological Safety, CJTF 132 Operation Plan No. 2-52

SPECIAL RADIOLOGICAL SAFETY REGULATIONS

1. The total integrated permissible dose for personnel participating in Operation IVY is 3.0 roentgens (measured gamma only), based on a three month operational period.
 - a. The maximum permissible exposures as stated above are applicable to a field experimental test of nuclear devices in peacetime, wherein numbers of personnel engaged in these tests have been previously exposed, or will be continuously exposed to potential radiation hazards. It may become necessary from a study of personnel records to adjust downwards the allowed total integrated dose for certain individuals who have participated recently in other atomic tests.
 - b. Under a military tactical situation the maximum permissible dose above does not apply.
 - c. Special instances may arise after shot time such as in the case of an air-sea rescue within the atoll lagoon and inside the surface RADEX in which rescue operations will be carried out without regard to the radiological hazard. Monitors aboard rescue craft shall be required to determine the extent of actual radiation hazard experienced in order that appropriate medical tests may be initiated.
2. Individuals or groups working in contaminated areas, or with contaminated equipment, shall be accompanied by radiological safety monitors. These monitors shall inform persons in charge of groups of the radiological hazards involved and when maximum permissible exposure will be reached. Advice of the radiological monitor relative to radiological hazards will be accepted. Every individual must cooperate to the fullest extent in minimizing the possibilities of over-exposure even though immediate physiological effects are not apparent. Personnel who become over-exposed shall be required to take radiological physical examinations as may be prescribed.
3. Names of all individuals who are expected to enter radioactive areas shall be submitted to CTG 132.1 in the form of an eligibility list two weeks prior to the test.
4. All islands in the atoll will be considered contaminated after each shot until reported clear by CJTF 132.
5. No aircraft in the air at H-Hour shall be closer than 20 miles slant range from the detonation point, and after detonation no aircraft shall operate inside the air RADEX or closer than 10 miles

from the rising column or visible cloud, unless specifically directed otherwise. If a tactical situation arises where aircraft must enter the air RADEX, tactical dosage allowances shall apply.

6. All persons in aircraft at shot time, or at subsequent times when engaged in operations in or near the cloud or RADEX track, shall wear film badges.
7. Pilots and copilots of aircraft in the air at shot time will use modified all-purpose .1 density filter goggles. Copilots should as an extra precaution, cover their eyes with forearm at zero hours.
8. All multi-engine Task Force aircraft in the air at H-Hour within 100 miles of the detonation point shall carry a person designated as radiological safety monitor equipped with suitable RADIAC equipment and a RADEX plot. This monitor shall be capable of calculating allowable exposures under both tactical and operational conditions.
9. Transportation of radioactive materials to and from the forward area shall be in accordance with AEC regulations for escorted shipment of such material. Monitoring of radioactive test materials enroute shall be the responsibility of escorting scientific personnel, under the direction of CTG 132.1
10. No radioactive material shall be removed from the test site except as authorized in experimental programs. Unauthorized entry into radioactive areas is prohibited.
11. No ships with personnel shall be permitted inside the lagoon or closer than 25 nautical miles from the shot island at the time of detonation. Bearings of danger from immediate radioactive fall-out for ship operations will be established by CJTF 132 on the basis of forecast wind directions at the intended time of detonation. This danger section will be designated as surface RADEX. All ships of the Task Force shall be required to remain outside the surface RADEX - danger bearings, radial limitation and time restriction. However, if ships are directed tactically into the surface RADEX, movement of ships shall be governed by tactical dosage guides.
12. Individuals on board ships of the Task Force shall be protected collectively from hazards of blast, heat and radioactivity by movement of the ships.
13. In general, boats operating in waters near shot islands after shot times may become contaminated. Monitors shall be aboard all boats operating north of PARRY ISLAND after shot time, either as passengers or members of the boat crew, until such time as radiological restrictions are lifted.
14. Film badges will be forwarded regularly to the laboratory of CTG 132.1, where all processing and recording will be accomplished. Copies of exposure records will be furnished to task group commanders.

Headquarters, Joint Task Force 132
WASHINGTON 25, D.C.
10 May 1952, 1800 R

Appendix III to Annex P
Radiological Safety, CJTF 132 Operation Plan No. 2-52

RADIOLOGICAL SAFETY CENTER

1. A radiological safety center will be established on shipboard (CVE) prior to shot time. This center will be established by CTG 132.1, and will serve as operations headquarters for all radiological safety activities of TG 132.1 while embarked. All radiological safety data will be collected at this center and forwarded to command center aboard Task Force flagship.
2. The Radiological Safety Center will maintain radiological situation data on all islands of the atoll, based on air and ground survey information, supplemented by monitor reports. This information will be the basis of periodic situation reports or maps and briefing information furnished to the Task Force and task group commanders.
3. The Radiological Safety Center, in coordination with CTG 132.4, who will develop the air RADEX plot, will assemble the overall RADEX situation. The Commander, JTF 132, will originate surface RADEX prior to shot time (forecast), and will originate messages from time to time after the shots, announcing radiological clearances of contaminated, or previously closed areas.
4. This Center will provide information for the planning of radiological safety operations, and for the disposition of all working parties within the contaminated area. It will establish radiological safety check points. It will maintain an operations table giving details for all groups who plan to enter contaminated areas each day, including name of monitor, destination, general type of mission (program or project number), and time of departure and arrival.
5. The Center will provide special clothing to previously designated recovery personnel, have cognizance over working schedule of the radiochemical laboratory, photo-dosimetry developing facilities, RADIAC repair, etc., of TG 132.1. Personnel decontamination facilities will be coordinated with existing ship facilities. In general, all equipment will be placed in operational readiness prior to evacuation from normal Radiological Safety Center (administrative) on PARRY ISLAND, in the radiological safety building.
6. Operational headquarters for the Radiological Safety Center ashore will be located in J-3 Operations Division wing of JTF 132 Headquarters building on PARRY ISLAND. It will be reestablished there upon reentry when operational conditions permit.

Headquarters, Joint Task Force 132
APO 187 (HOW), c/o Postmaster
San Francisco, California
8 October 1952, 1600 M

Annex T to CJTF Operation Order No. 2-52

SHOT PHASE EVACUATION PLAN

1. See Annex A, Concept of Operations, for narrative of the evacuation concept as it relates to the overall operation.
2. This evacuation plan contemplates the employment of two (2) transport ships of the AP type to accommodate the bulk of Task Force personnel; generally, one transport for elements of TG 132.1 and one transport for the military elements of the Task Force, plus TG 132.1 overflow personnel. Other ships of the Task Force permit complete evacuation of all personnel from ENIWETOK ATOLL.
3. The bulk of Task Force personnel and specified critical equipment supplies and materiel based on ENIWETOK ATOLL will be moved afloat prior to 1200 on M minus 1 day. The limited number of remaining personnel will be evacuated aboard ships departing from the ENIWETOK lagoon not later than H minus 5 hours. When rad-safe conditions following MIKE shot permit, shore parties necessary for collection of data, repair of vital installations and for preparation for KING shot will be disembarked. Total evacuation of personnel on ENIWETOK ATOLL during the second shot (KING shot) may not be necessary. However, if emergency evacuation of all personnel is not determined essential by CJTF, the general procedures set forth in this plan for MIKE shot will also apply for KING shot.
4. The conference at Los Alamos Scientific Laboratory on 10 June 1952 which is summarized in HQ CTG 132.1 letter, file J-12372, subject: "Report of Evacuation Plans Conference", dated 24 June 1952 is the guide for making plans for the evacuation of equipment and materiel during MIKE shot. The blast, thermal, water wave and radiological effects predictions and conclusions for MIKE shot outlined in this reference represent the consensus of the recognized authorities in the respective fields. To insure that the calculated risks assumed for this operation are predicated on sound principles and the best advice available, it is directed that all JTF 132 organizations employ the predictions and conclusions indicated in the referenced letter for resolution of damage estimation and evacuation problems.
5. The Commander, TG 132.2 is responsible for evacuation of personnel based on ENIWETOK ISLAND, for critical equipment under his jurisdiction and for detailed loading plans for personnel assigned to the USNS GENERAL E.T. COLLINS (TAP-147). The commander, TG 132.1 is responsible for evacuation of personnel based on other islands of ENIWETOK ATOLL, for critical equipment under his jurisdiction and for detailed loading plans for personnel assigned to the USS CURTISS (AV-4) and USNS DAVID A. SHANKS (TAP-180).

6. This annex establishes general procedures for conduct of the evacuation plan outlined above and for safeguarding of facilities and materiel remaining ashore during shot periods.

Commander [JTF 132]

Headquarters, Joint Task Force 132
WASHINGTON 25, D.C.
10 May 1952, 1800 R

Annex U to CJTF 132 Operation Plan No. 2-53

POST-SHOT REENTRY PLAN

1. See Annex A, Concept of Operations, for narrative of the reentry concept as it related to the overall operation.
2. This plan provides for major elements of the Task Force remaining afloat until after the second shot (KING). In general, Appendix I outlines procedures for temporary reentry following MIKE shot of shore parties (operating from quarters aboard ship) to collect data, make repairs, and to prepare for KING shot. Appendix II outlines procedures for phasing the full scale reentry of the Task Force following KING shot. (If it is determined that evacuation of the Task Force during KING shot is not necessary, the procedures outlined in Appendix II will apply for the full scale reentry of the Task Force following MIKE shot.)
3. Following MIKE shot, radiological safety monitors will enter ENIWETOK ATOLL to determine the radiological safety situation. From information thus obtained, plus cloud tracking information, CJTF 132 will announce R-Hour. When radiological safety conditions permit, the Task Force will return to ENIWETOK lagoon, and disembark shore parties for limited periods. Shore parties will conduct shore operations from quarters aboard ship, and will consist of selected individuals essential for the collection of data from MIKE shot, for repair of vital installations, and for preparation of instrumentation for KING shot. Upon completion of preparations for KING shot, the Task Force afloat departs ENIWETOK lagoon and proceeds to a designated rendezvous. After detonation of KING shot, radiological safety activities mentioned above will be repeated, a new R-Hour will be announced, and at an appropriate time the Task Force will return to ENIWETOK ATOLL to disembark all personnel and equipment. The full scale reentry and disembarkation of the Task Force will be phased over several days to permit decontamination, if required, and reopening and operation of based facilities. After KING shot the aim will be to establish normal shore base operations as early as possible.
4. This annex establishes general procedures for conduct of the reentry plan outlined above. Instructions contain herein will, to a large extent, be supplemented by on-site fragmentary directives issued by the CJTF 132 inasmuch as all reentry operations hinge on the prevailing radiological and weather situation.
5. The procedures set forth in Appendices I and II are based on the assumption that radiological hazards or damage resulting from either shot will not excessively delay or preclude reentry of Task Force personnel. Appendix III establishes general procedures to be followed in the event reentry into the atoll is excessively delayed

or precluded by unforeseen developments resulting from either shot. However remote this possibility, reentry plans promulgated by task groups must take cognizance of this eventuality.

Commander [JTF 132]

Appendix

- I - Reentry Following MIKE Shot
- II - Reentry Following KING Shot
- III - Alternative Destination Landings

OFFICIAL:

(signed)
Assistant Chief of Staff, J-3

Headquarters, Joint Task Force 132
WASHINGTON 25, D.C.
10 May 1952, 1800 R

Appendix I to Annex U
Post-Shot Reentry Plan, CJTF 132 Operation Plan No. 2-52

REENTRY FOLLOWING MIKE SHOT

1. Within several hours after MIKE shot monitors accomplish a damage and radiological survey of ENIWETOK ATOLL via helicopters launched from the CVE. Task Force Commander's announcement of R-Hour is based on results of this survey, atomic cloud tracking reports and aerological prognostications. The initial radiological survey for ENIWETOK ATOLL is reconnaissance in nature and does not provide for reentry of key recovery personnel until results of the radiological survey have been evaluated.
2. R-Hour is announced when it is radiologically safe to permit reentry into designated areas for limited periods. As soon after R-Hour as is feasible, early reentry teams leave CVE by helicopter and proceed to those islands; and LORAN Detachment Commander and technician are flown to ENIWETOK to check operation of the LORAN station. Other helicopter flights to critical islands by key scientific personnel are conducted from the CVE, consistent with radiological safety conditions. Such flights are limited to those required for collection of radiological safety data, and for early scientific recovery task essential to the performance of the mission of CTG 132.1
3. Expected weather and radiological safety conditions within 48 hours permitting, the Task Force afloat returns to assigned positions in the ENIWETOK lagoon. At that time shore parties commence operations.
4. Shore operations are conducted from quarters aboard ship by limited numbers of shore party personnel thereby obviating the necessity of reestablishing shore installations, and facilitating rapid preparation for KING shot. Individuals are assigned to shore parties on a "must go" basis. Personnel not assigned to shore parties will not return ashore without specific approval of CJTF 132. The number of individuals assigned to shore parties will not exceed that total which can be sustained without reestablishing shore installations; estimated at 200 persons. Persons considered essential for shore party operations include:

Radiological safety monitors
Scientific personnel for collection of MIKE shot data
Scientific personnel for KING shot instrumentation
Holmes & Narver instrumentation, powerhouse, salvage and repair crews.

LORAN Detachment
Documentary Photo Team
TG 132.1 shore based command post group

Shore to ship communications detail
Boat pool personnel
Helicopter pilots

5. Transportation of shore parties is accomplished by ships' boats where feasible, LCMs dispatched from LSD, and by helicopter dispatched from the CVE. Vehicles and equipment necessary for shore operations are discharged from ships upon return of the Task Force to the lagoon, and are kept ashore during shore operations.
6. Upon completion of shore party operations following MIKE shot, the rehearsal, security sweep, muster and evacuation procedures as set forth in Annex T are repeated for KING shot.

Commander [JTF 132]

OFFICAL:

(signed)
Assistant Chief of Staff, J-3

Headquarters, Joint Task Force 132
WASHINGTON 25, D.C.
10 May 1952, 1800 R

Appendix II to Annex U
Post-Shot Reentry Plan, CJTF 132 Operation Plan 2-52

REENTRY FOLLOWING KING SHOT

1. Procedures set forth in paragraph 1 and 2 of Appendix I, governing the reentry of radiological safety monitors and early recovery personnel, are repeated.
2. a. Disembarkation of the bulk of the Task Force personnel and discharge of cargo is phased over several days during which house-keeping and maintenance personnel prepare islands for full occupancy. Personnel to accomplish the following functions will be sent ashore initially:
 - (1) Resumption of attended operation of LORAN station.
 - (2) Decontamination of critical installations, if required.
 - (3) Reestablishment of water supply, electrical power and laundry systems.
 - (4) Preparation of ration distribution and messing facilities.
 - (5) Reestablishment of shore based command posts, communications facilities and aid stations.
 - (6) Security of installations and materiel by military police during activities mentioned above.
- b. Shipboard command posts remain operative until above activities have been accomplished and bulk of land based personnel return ashore.
3. All Task Force ships, boats, aircraft and personnel remain in forward area under operational control of CJTF 132 until instruction to the contrary are issued.

Commander [JTF 132]

OFFICIAL:

(signed)
Assistant Chief of Staff, J-3

APPENDIX C
RADIOLOGICAL EXPOSURE DATA FOR ISLANDS OF ENEWETAK ATOLL, IVY

Table C-1. Radiological exposure data for Bokoluo.^a

Date	Time	Ground Reading (R/hr)	Air Reading (R/hr)	Remarks
1 Nov 52	1300		2.500	1,500 feet, east side
			1.200	1,500 feet, west side
			7.000	1,500 feet, center
			0.400	1,500 feet, lagoon
2 Nov 52	0700		14.000	
3 Nov 52	0800	22.000		
	1230	18.000		
4 Nov 52	0830		10.000	Island center
			6.000	Inner reef
5 Nov 52	0830	10.000	3.000	
6 Nov 52	0815	5.000		Island center
7 Nov 52	0800	3.900	1.500	Island center
8 Nov 52	0815	3.500	1.400	Island center
9 Nov 52	0805	2.800	1.300	Island center
10 Nov 52	0815	2.200	0.800	Island center
11 Nov 52	0815	1.700		Island center
12 Nov 52	0815	2.100	0.800	Doubtful values
14 Nov 52	1630		0.800	Island center
15 Nov 52	0815		0.800	Radiation spotty at this time
16 Nov 62	1230		0.750	KING day
	1630		0.500	
17 Nov 52	0830	1.400	0.440	
18 Nov 52	0810	1.000	0.500	
19 Nov 52	0900		0.210	
3 Jan 53		0.150		Radiation varies with location, weathering causes changes in concentration
9 Feb 53		0.010-0.100		

Note:

^a3 nmi (5.6 km) from MIKE ground zero.

Source: Reference C.1.7.1, p. 39.

Table C-2. Radiological exposure data for Bokombako.^a

Date	Time	Ground Reading (R/hr)	Air Reading (R/hr)	Remarks
2 Nov 52	0700		16.000	Island center
3 Nov 52	0757		8.000	Island center
4 Nov 52	0827		10.000	Island center
5 Nov 52	0827	10.000	3.800	Island center
6 Nov 52	0812	7.000		
7 Nov 52	0757	4.500	1.500	Island center
8 Nov 52	0812	3.600	1.400	Island center
9 Nov 52	0802		1.400	Island center
10 Nov 52	0812	2.400	1.000	Island center
11 Nov 52	0812		0.700	Island center
12 Nov 52	1627	1.950	0.900	Island center
14 Nov 52	0827		1.000	Island center
15 Nov 52	0812		0.900	Island center
16 Nov 52	1227	1.200	0.900	Island center
17 Nov 52	0827		0.500	Island center
18 Nov 52	0807	1.000	0.450	Island center
19 Nov 52	0857		0.260	Island center
21 Nov 52	0957	0.800		Island center
3 Jan 53		0.180		Island center
9 Jan 53		0.080-0.090		Island center

Note:

^a2-1/4 nmi (4.2 km) from ground zero.

Source: Reference C.1.7.1, p. 40.

Table C-3. Radiological exposure data for Kirunu.^a

Date	Time	Ground Reading (R/hr)	Air Reading (R/hr)	Remarks
2 Nov 52	0657		16.000	Island center
3 Nov 52	0754		8.000	Island center
4 Nov 52	0824		9.000	Island center
5 Nov 52	0824		3.400	Island center
6 Nov 52	0809		4.000	Island center
7 Nov 52	0754		1.400	Island center
8 Nov 52	0809		1.600	Island center
9 Nov 52	0759	2.500	1.300	Island center
10 Nov 52	0809	2.600	0.800	Island center
11 Nov 52	0808		0.425	Island center
12 Nov 52	1624		0.700	Island center
14 Nov 52	0822		1.000	Variable radiation levels on island
15 Nov 52	0808		0.800	Variable radiation levels on island
16 Nov 52	1224		0.400	Variable radiation levels on island
17 Nov 52	0824		0.420	Variable radiation levels on island
19 Nov 52	0854		0.180	Variable radiation levels on island
21 Nov 52	0954	0.700		Variable radiation levels on island
3 Jan 53		0.150		Variable radiation levels on island
9 Feb 53		0.010-0.090		Variable radiation levels on island

Note:

^a1-1/2 nmi (2.8 km) from ground zero.

Source: Reference C.1.7.1, p. 41.

Table C-4. Radiological exposure data for Louj.^a

Date	Time	Ground Reading (R/hr)	Air Reading (R/hr)	Remarks
3 Nov 52	0751		8.000	Island center
4 Nov 52	0821		10.000	Island center
5 Nov 52	0820		6.000	Island center
6 Nov 52	0806	7.000		Island center
7 Nov 52	0751	5.700	2.000	Island center
8 Nov 52	0805	4.500	1.800	Island center
9 Nov 52	0756	3.300	1.500	Island center
11 Nov 52	0806		0.800	Island center
12 Nov 52	1623	2.200	0.700	Island center
14 Nov 52	0820		1.000	Radiation varies with location
15 Nov 52	0804		1.000	Radiation varies with location
16 Nov 52	1235	1.400	0.800	Radiation varies with location
17 Nov 52	0820		0.700	Radiation varies with location
19 Nov 52	0850		0.700	Radiation varies with location
21 Nov 52	0950	0.900		Radiation varies with location
3 Jan 53		0.200		Radiation varies with location
7 Feb 53		0.010-0.200		Radiation varies with location

Note:

^a1-1/2 nmi (2.8 km) from ground zero.

Source: Reference C.1.7.1, p. 42.

Table C-5. Radiological exposure data for Bokinwotme.^a

Date	Time	Ground Reading (R/hr)	Air Reading (R/hr)	Remarks
4 Nov 52	0816	26.000	6.000	Island center
5 Nov 52	0817	20.000		Island center
8 Nov 52	0800		6.000	Island center
9 Nov 52	0751		3.300	Island center
10 Nov 52	0805	8.000	3.000	Island center
11 Nov 52	0801		3.800	Island center
14 Nov 52	0815		2.200	Island center
15 Nov 52	0800		2.200	Island center
16 Nov 52	1230		2.000	Island center
17 Nov 52	0810	2.800	1.200	Island center
21 Nov 52	0945	1.700		Island center
3 Jan 53		0.500-1.600		Island center
7 Jan 53		0.100-1.000		Island center

Note:

^a3/4 nmi (1.4 km) from ground zero.

Source: Reference C.1.7.1, p. 43.

Table C-6. Radiological exposure data for Eluklab.^{a,b}

Date	Time	Ground Reading (R/hr)	Air Reading (R/hr)	Remarks
3 Nov 52	0813		8.000	50 feet over water
5 Nov 52	0813		0.014	25 feet over water
7 Nov 52	0748		0.020	25 feet over water
8 Nov 52	0754		0.010	25 feet over water
9 Nov 52	0748		0.020	25 feet over water
16 Nov 52	1630	0.007	0.002	25 feet over water
18 Nov 52	0804		0.001	25 feet over water
19 Nov 52	0847		0.002	25 feet over water

Notes:

^aMIKE ground zero.

^bCrater began to fill shortly after detonation; thus radioactivity of the crater bottom began to diminish because of decay, flushing, and burial.

Source: Reference C.1.7.1, p. 43.

Table C-7. Radiological exposure data for Dridrilbwij.^a

Date	Time	Ground Reading (R/hr)	Air Reading (R/hr)	Remarks
3 Nov 52	0810		36.000	Island center
4 Nov 52	0813		18.000	Island center
5 Nov 52	0810		12.000	Island center
7 Nov 52	0745		8.000	Island center
8 Nov 52	0751	18.000	6.000	Island center
9 Nov 52	0745	8.000	3.400	Island center
10 Nov 52	0806		3.500	Island center
11 Nov 52	0803	3.600		Island center
12 Nov 52	1620		1.400	Island center
14 Nov 52	0830		1.200	Island center
16 Nov 52	1230		2.400	KING day
	1630		1.800	Island center
17 Nov 52	0806		1.600	Island center
18 Nov 52	0800	2.500	1.000	Island center
21 Nov 52	0942	2.000		Island center
3 Jan 53		0.340-1.000		
9 Feb 53		0.100-1.000		

Note:

^a1/2 nmi (0.9 km) from ground zero.

Source: Reference C.1.7.1, p. 44.

Table C-8. Radiological exposure data for Bokaidrikdrik.^a

Date	Time	Ground Reading (R/hr)	Air Reading (R/hr)	Remarks
3 Nov 52	0805		13.000	Island center
5 Nov 52	0807		8.000	Island center
7 Nov 52	0742		2.200	Island center
8 Nov 52	0748		1.800	Island center
9 Nov 52	0742		1.700	Island center
11 Nov 52	0800	2.400		Island center
12 Nov 52	1616		0.800	Island center
15 Nov 52	0801		1.600	Island center
16 Nov 52	1230		1.000	KING day
	1623		0.700	Island center
17 Nov 52	0803		0.600	Island center
18 Nov 52	0757		0.600	Island center
19 Nov 52	0844		0.340	
21 Nov 52	0939	1.200		
3 Jan 53		0.280		

Note:

^a3/4 nmi (14. km) from ground zero.

Source: Reference C.1.7.1, p. 45.

Table C-9. Radiological exposure data for Boken.^a

Date	Time	Ground Reading (R/hr)	Air Reading (R/hr)	Remarks
1 Nov 52	1245		10.000 1.000	500 feet above blockhouse 1,500 feet above blockhouse
3 Nov 52	0802	27.000	10.000	25 feet above island
4 Nov 52	0810	14.000		Blockhouse
5 Nov 52	0804		8.000	Blockhouse
6 Nov 52	0803	8.000	4.000	Blockhouse
7 Nov 52	0739	7.800-10.000	2.500	General levels
8 Nov 52	0745	5.000	1.800	General levels
9 Nov 52	0738	3.800	2.000	General levels
10 Nov 52	0803	4.200		General levels
11 Nov 52	0747	1.700		General levels
12 Nov 52	1613	2.400	1.000	General levels
14 Nov 52	0827	2.400	1.000	General levels
15 Nov 52	0758	2.200		General levels
16 Nov 52	1220	1.600	1.200	General levels
	1630		0.900	General levels
17 Nov 52	0800		0.800	General levels
18 Nov 52	0754	1.500	0.500	General levels
19 Nov 52	0841		0.490	General levels
21 Nov 52	0936	1.200		General levels
3 Jan 53		0.200		General levels
9 Feb 53		0.008-0.080		General levels

Note:

^a1-1/4 nmi (2.3 km) from ground zero.

Source: Reference C.1.7.1, p. 46.

Table C-10. Radiological exposure data for Enjebi.^a

Date	Time	Ground Reading (R/hr)	Air Reading (R/hr)	Remarks
1 Nov 52	1240		Over 50.000	150 feet above island center
2 Nov 52	0656		19.000	Island center
3 Nov 52	0758	12.000	6.000	Island center
4 Nov 52	0806		3.300	Island center
5 Nov 52	0800	10.000	3.000	Island center
6 Nov 52	0759	2.800-3.900		2.800 R/hr, south tip; 3.900 R/hr, north tip
7 Nov 52	0735	3.900	1.400	
8 Nov 52	0740	2.400 2.200	1.400	Northwest tip South tip Northeast tip
9 Nov 52	0734	2.500	1.400	Island center
10 Nov 52	0800	2.400 2.000 1.400		Northwest tip Northeast tip South tip
11 Nov 52	0753		0.800	Northeast tip
12 Nov 52	1609	1.500	0.900	Northeast tip
14 Nov 52	0823		0.800	Northwest tip
15 Nov 52	0754	1.400	0.600	Center
16 Nov 52	1216 1626	1.100	0.480 0.450	South tip Center
17 Nov 52	0757	0.900	0.430	Center
18 Nov 52	0750	0.850	0.310	Center
19 Nov 52	0836	0.500	0.200	Northeast tip
21 Nov 52	0930	0.800		Center
3 Jan 53		0.150		Center

Note:

^a2-3/4 nmi (5.1 km) from ground zero.

Source: Reference C.1.7.1, p. 47.

Table C-11. Radiological exposure data for Mijikadrek.^a

Date	Time	Ground Reading (R/hr)	Air Reading (R/hr)	Remarks
2 Nov 52	0654		13.000	Island center
3 Nov 52	0756		4.400	Island center
4 Nov 52	0806		2.200	Island center
5 Nov 52	0758	4.000	1.800	Island center
7 Nov 52	0734		0.800	Island center
8 Nov 52	0738		0.700	Island center
9 Nov 52	0734		0.900	Island center
10 Nov 52	0758		0.500	Island center
11 Nov 52	0750		0.400	Island center
12 Nov 52	1607		0.300	Island center
14 Nov 52	0821		0.460	Island center
15 Nov 52	0752		0.400	Island center
16 Nov 52	1230		0.330	Island center
	1630		0.280	Island center
17 Nov 52	0755		0.310	Island center
18 Nov 52	0748		0.220	Island center
19 Nov 52	0834		0.110	Island center
21 Nov 52	0927	0.630		Island center
3 Jan 53		0.120		Island center

Note:

^a3-1/4 nmi (6.0 km) from ground zero.

Source: Reference C.1.7.1, p. 48.

Table C-12. Radiological exposure data for Kidrinen.^a

Date	Time	Ground Reading (R/hr)	Air Reading (R/hr)	Remarks
2 Nov 52	0652		13.000	Island center
3 Nov 52	0754	12.000	3.200	Island center
4 Nov 52	0804		2.000	Island center
5 Nov 52	0756		1.400	Island center
6 Nov 52	0752		1.800	Island center
7 Nov 52	0731	2.000	0.800	Island center
8 Nov 52	0736	1.600	0.800	Island center
9 Nov 52	0732		0.800	Island center
10 Nov 52	0756		0.500	Island center
11 Nov 52	0748		0.375	Island center
12 Nov 52	1605		0.360	Island center
14 Nov 52	0819		0.410	Island center
15 Nov 52	0750	0.900	0.200	Island center
16 Nov 52	1227		0.340	KING day
	1624		0.240	Island center
17 Nov 52	0754		0.260	Island center
18 Nov 52	0746		0.280	Island center
19 Nov 52	0832		0.100	Island center
21 Nov 52	0925	0.430		Island center
3 Jan 53		0.110		Island center

Note:

^a3-3/4 nmi (6.9) from ground zero.

Source: Reference C.1.7.1, p. 49.

Table C-13. Radiological exposure data for Bokenelab.^a

Date	Time	Ground Reading (R/hr)	Air Reading (R/hr)	Remarks
2 Nov 52	0649		12.000	Island center
3 Nov 52	0751	9.000	2.800	Island center
4 Nov 52	0801		2.300	Island center
5 Nov 52	0756		1.500	Island center
6 Nov 52	0748	2.000	1.000	Island center
7 Nov 52	0728	1.800	0.400	Island center
8 Nov 52	0733	0.900	0.420	Island center
9 Nov 52	0729		0.700	Island center
10 Nov 52	0752	1.300	0.410	Island center
11 Nov 52	0745		0.260	Island center
12 Nov 52	1602	0.600	0.240	Island center
14 Nov 52	0816		0.280	Island center
15 Nov 52	0747	0.440	0.110	Island center
16 Nov 52	1224		0.280	KING day
	1620		0.140	Island center
17 Nov 52	0751	0.410	0.190	Island center
18 Nov 52	0743	0.200	0.130	Island center
19 Nov 52	0829		0.050	Island center
21 Nov 52	0922	0.320		
3 Jan 53		0.080		

Note:

^a5 nmi (9.3 km) from ground zero.

Source: Reference C.1.7.1, p. 50.

Table C-14. Radiological exposure data for Elle.^a

Date	Time	Ground Reading (R/hr)	Air Reading (R/hr)	Remarks
2 Nov 52	0647		10.000	
3 Nov 52	0749		2.200	
4 Nov 52	0759		1.400	
5 Nov 52	0746		1.100	
6 Nov 52	0726		0.800	
7 Nov 52	0725		0.400	
8 Nov 52	0731		0.250	
9 Nov 52	0726		0.700	Doubtful value
10 Nov 52	0742	1.000	0.300	
11 Nov 52	0742		0.255	
12 Nov 52	1559		0.160	
14 Nov 52	0814		0.240	
15 Nov 52	0747		0.100	
16 Nov 52	1221		0.160	KING day
	1619		0.120	
17 Nov 52	0749		0.130	
18 Nov 52	0741	0.400	0.100	
19 Nov 52	0827		0.040	
21 Nov 52	0919	0.230		
3 Jan 53		0.070		

Note:

^a5-1/2 nmi (10.2 km) from ground zero.

Source: Reference C.1.7.1, p. 51.

Table C-15. Radiological exposure data for AeJ.^a

Date	Time	Ground Reading (R/hr)	Air Reading (R/hr)	Remarks
2 Nov 52	0645		10.000	Island center
3 Nov 52	0747		2.400	Island center
4 Nov 52	0756		1.500	Island center
5 Nov 52	0744		1.200	Island center
6 Nov 52	0723		1.000	Island center
7 Nov 52	0722	1.000	0.500	Island center
8 Nov 52	0729		0.340	Island center
9 Nov 52	0723		0.700	Island center
10 Nov 52	0739	0.900	0.340	Island center
11 Nov 52	0739		0.215	Island center
12 Nov 52	1556	0.440	0.180	Island center
14 Nov 52	0811		0.280	Island center
15 Nov 52	0744		0.160	Island center
16 Nov 52	1218	0.310	0.220	KING day
	1616		0.140	
17 Nov 52	0747		0.150	Island center
18 Nov 52	0738		0.085	Island center
19 Nov 52	0824		0.040	Island center
21 Nov 52	0916	0.260		Island center
3 Jan 53		0.045		

Note:

^a6 nmi (11.1 km) from ground zero.

Source: Reference C.1.7.1, p. 52.

Table C-16. Radiological exposure data for Lujor.^a

Date	Time	Ground Reading (R/hr)	Air Reading (R/hr)	Remarks
2 Nov 52	0642		10.000	Island center
3 Nov 52	0744	8.000	2.700	Island center
4 Nov 52	0754	4.000	1.500	Island center
5 Nov 52	0741		1.200	Island center
6 Nov 52	0720		0.900	Island center
7 Nov 52	0719	1.600	0.500	Island center
8 Nov 52	0725	0.800	0.390	Island center
9 Nov 52	0720		0.600	Doubtful value
10 Nov 52	0736	0.900	0.380	Island center
11 Nov 52	0735		0.265	Island center
12 Nov 52	1554	0.480	0.200	Island center
14 Nov 52	0809		0.190	Island center
15 Nov 52	0741		0.110	Island center
16 Nov 52	1215		0.150	KING day
	1614		0.100	
17 Nov 52	0744		0.050	Island center
18 Nov 52	0735	0.260	0.080	Island center
19 Nov 52	0821		0.045	Island center
21 Nov 52	0913	0.240		Island center
3 Jan 53		0.050		

Note:

^a6-1/2 nmi (12.0 km) from ground zero.

Source: Reference C.1.7.1, p. 53.

Table C-17. Radiological exposure data for Eleleron.^a

Date	Time	Ground Reading (R/hr)	Air Reading (R/hr)	Remarks
2 Nov 52	0640		4.000	Island center
3 Nov 52	0741		2.100	Island center
4 Nov 52	0751	4.000	1.000	Island center
5 Nov 52	0739		0.800	Island center
6 Nov 52	0717		0.700	Island center
7 Nov 52	0717		0.360	Island center
8 Nov 52	0722		0.200	Island center
9 Nov 52	0717	0.600		
10 Nov 52	0733		0.260	Island center
11 Nov 52	0732		0.200	Island center
12 Nov 52	1551		0.140	Island center
14 Nov 52	0806		0.190	Island center
15 Nov 52	0739		0.110	Island center
16 Nov 52	1212		0.150	KING day
	1611		0.100	
17 Nov 52	0741		0.050	Island center
18 Nov 52	0732		0.045	Island center
19 Nov 52	0818		0.045	Island center
21 Nov 52	0910	0.240		Island center
3 Jan 53		0.060		

Note:

^a7-1/8 nmi (13.2 km) from ground zero.

Source: Reference C.1.7.1, p. 54.

Table C-18. Radiological exposure data for Aomon.^a

Date	Time	Ground Reading (R/hr)	Air Reading (R/hr)	Remarks
2 Nov 52	0638		3.800	Island center
3 Nov 52	0739		2.600	Island center
4 Nov 52	0749	2.600-4.800	1.000	Island center
5 Nov 52	0737		1.100	Island center
6 Nov 52	0715	1.200		Island center
7 Nov 52	0714		0.400	Island center
8 Nov 52	0720		0.240	Island center
9 Nov 52	0715		0.700	Island center
10 Nov 52	0731		0.300	Island center
11 Nov 52	0730		0.260	Island center
12 Nov 52	1549		0.110	Island center
14 Nov 52	0804	0.280	0.150	Island center
15 Nov 52	0737		0.120	Island center
16 Nov 52	1210	0.200	0.120	KING day
	1609		0.140	
17 Nov 52	0739		0.160	Island center
18 Nov 52	0730		0.080	Island center
19 Nov 52	0816		0.048	Island center
21 Nov 52	0908	0.240		
3 Jan 53		0.060		Island center

Note:

^a7-3/4 nmi (14.4 km) from ground zero.

Source: Reference C.1.7.1, p. 55.

Table C-19. Radiological exposure data for Bijire.^a

Date	Time	Ground Reading (R/hr)	Air Reading (R/hr)	Remarks
2 Nov 52	0636		3.000	Island center
3 Nov 52	0737	2.800	1.800	Island center
4 Nov 52	0747	2.000	1.000	Island center
5 Nov 52	0735		0.800	Island center
6 Nov 52	0713		0.600	Island center
7 Nov 52	0712	0.600	0.240	Island center
8 Nov 52	0718		0.240	Island center
9 Nov 52	0713	0.600	0.200	Island center
10 Nov 52	0729	0.480	0.200	Island center
11 Nov 52	0728	0.340		
12 Nov 52	1547		0.110	Island center
14 Nov 52	0802	0.280	0.150	Island center
15 Nov 52	0735	0.270	0.130	Island center
16 Nov 52	1208 1607	0.200 0.210	0.120	Island center
17 Nov 52	0737	0.200	0.090	Island center
18 Nov 52	0728	0.200	0.090	Island center
19 Nov 52	0814	0.100	0.040	Island center
21 Nov 52	0906	0.160		
3 Jan 53		0.040		Island center

Note:

^a8 nmi (14.8 km) from ground zero.

Source: Reference C.1.7.1, p. 56.

Table C-20. Radiological exposure data for Lojwa.^a

Date	Time	Ground Reading (R/hr)	Air Reading (R/hr)	Remarks
2 Nov 52	0634	12.000	2.000	Island center
3 Nov 52	0735	3.000	1.200	Island center
4 Nov 52	0745	1.600	0.800	Island center
5 Nov 52	0733		0.600	Island center
6 Nov 52	0711	0.600	0.440	Island center
7 Nov 52	0710	0.400	0.200	Island center
8 Nov 52	0716	0.400	0.200	Island center
9 Nov 52	0711	0.400	0.180	Island center
10 Nov 52	0727	0.340	0.140	Island center
11 Nov 52	0726	0.240		
12 Nov 52	1545	0.200	0.090	Island center
14 Nov 52	0800	0.210	0.110	Island center
15 Nov 52	0733	0.190	0.090	Island center
16 Nov 52	1206		0.100	KING day
	1605		0.070	
17 Nov 52	0735	0.150	0.070	Island center
18 Nov 52	0726	0.140	0.050	Island center
19 Nov 52	0812		0.026	Island center
21 Nov 52	0903	0.100		Island center
3 Jan 53		0.030		Island center

Note:

^a8-3/8 nmi (15.5 km) from ground zero.

Source: Reference C.1.7.1, p. 57.

Table C-21. Radiological exposure data for Alembel.^a

Date	Time	Ground Reading (R/hr)	Air Reading (R/hr)	Remarks
2 Nov 52	0632		1.600	Island center
3 Nov 52	0733		0.800	Island center
4 Nov 52	0743		0.280	Island center
5 Nov 52	0731		0.230	Island center
6 Nov 52	0709		0.260	Island center
7 Nov 52	0708		0.100	Island center
8 Nov 52	0714		0.120	Island center
9 Nov 52	0709		0.120	Island center
10 Nov 52	0725		0.100	Island center
11 Nov 52	0724		0.055	Island center
12 Nov 52	1543		0.090	Island center
14 Nov 52	0758		0.060	Island center
15 Nov 52	0731		0.031	Island center
16 Nov 52	1203 1602		0.048 0.031	KING day
17 Nov 52	0733	0.080	0.034	Island center
18 Nov 52	0724		0.024	Island center
19 Nov 52	0809		0.018	Island center
21 Nov 52	0900	0.080		Island center
3 Jan 53		0.020		Island center

Note:

^a8-3/4 nmi (16.2 km) from ground zero.

Source: Reference C.1.7.1, p. 58.

Table C-22. Radiological exposure data for Billae.^a

Date	Time	Ground Reading (R/hr)	Air Reading (R/hr)	Remarks
1 Nov 52	0800		8.000	Island center
2 Nov 52	0630	4.200	1.400	Island center
3 Nov 52	0731	1.700	0.700	Island center
4 Nov 52	0740		0.220	Island center
5 Nov 52	0729		0.220	Island center
6 Nov 52	0707		0.210	Island center
7 Nov 52	0705		0.100	Island center
8 Nov 52	0711		0.200	Island center
9 Nov 52	0706		0.100	Island center
10 Nov 52	0722	0.060		Island center
11 Nov 52	0721		0.042	Island center
12 Nov 52	1541	0.090	0.040	Island center
14 Nov 52	0753		0.040	Island center
15 Nov 52	0729		0.026	Island center
16 Nov 52	1200 1601		0.040 0.027	KING day
17 Nov 52	0731	0.070	0.028	Island center
18 Nov 52	0721	0.080	0.021	Island center
19 Nov 52	0806		0.012	Island center
21 Nov 52	0857	0.045		Island center
3 Jan 53		0.012		Island center

Note:

^a9 nmi (16.7 km) from ground zero.

Source: Reference C.1.7.1, p. 59.

Table C-23. Radiological exposure data for Runit.^a

Date	Time	Ground Reading (R/hr)	Air Reading (R/hr)	Remarks
1 Nov 52	0745	1.200	0.300	Center
	0747		5.000	North tip
	0743		0.005	South tip
2 Nov 52	0627	0.045	0.020	South tip
	0628	0.180		Center
	0629	1.000		North tip
3 Nov 52	0726	0.025-0.180		South-North
4 Nov 52	0736	0.025-0.120		South-North
5 Nov 52	0725	0.030		Center
6 Nov 52	0707	0.025-0.090		South-North
7 Nov 52	0700	0.050	0.015	North tip
8 Nov 52	0705		0.019	Center
9 Nov 52	0701		0.012-0.016	South-North
10 Nov 52	0717	0-0.024		South-North
11 Nov 52	0716			North tip
12 Nov 52	1536	0.016	0.004	North tip
14 Nov 52	0749	0.010	0.008	North tip
15 Nov 52	0724	0.012	0.005	Center
16 Nov 52	1155		0-3.800	South-North
	1555		0-0.450	South-North
17 Nov 52	0726	0.001-0.100		South-North
18 Nov 52	0716	0.030	0.002	Center
19 Nov 52	0801	0-0.004		South-North
21 Nov 52	0852		0.008	South-North
3 Jan 53		0		

Note:

^a11-3/4 nmi (21.8 km) from ground zero.

Source: Reference C.1.7.1, p. 60

Table C-24. Radiological exposure data for Kidreenen.^a

Date	Time	Ground Reading (R/hr)	Air Reading (R/hr)	Remarks
2 Nov 52	0735	0.014	0.004	Island center
4 Nov 52	0830	0		Island center
16 Nov 52	1710		0.0016	KING day
17 Nov 52	0832		0.0013	Island center

Note:

^a17-1/2 nmi (32.4 km) from ground zero.

Source: Reference C.1.7.1, p. 61.

Table C-25. Radiological exposure data for Biken.^a

Date	Time	Ground Reading (R/hr)	Air Reading (R/hr)	Remarks
2 Nov 52	0725	0.300	0.120	Island center
4 Nov 52	0820	0.095		Island center
5 Nov 52	0816		0.030	Island center
7 Nov 52	0800		0.014	Island center
8 Nov 52	0805		0.010	Island center
10 Nov 52	0801	0.017	0.004	Island center
16 Nov 52	1700	0.027		Island center
17 Nov 52	0822	0.009	0.005	Island center
18 Nov 52	0816	0.008		Island center

Note:

^a13-3/4 nmi (25.5 km) from ground zero.

Source: Reference C.1.7.1, p. 61.

APPENDIX D
TERMS, ABBREVIATIONS, ACRONYMS, AND UNITS

Many of the definitions in this glossary relating to nuclear device and radiation phenomena have been quoted or extracted from The Effects of Nuclear Weapons (3rd edition), S. Glasstone and P.J. Dolan, 1977.

AA&GM. Anti-Aircraft Artillery and Guided Missile Center, Ft. Bliss, Texas (Army).

AACS. Airways and Air Communication Service (Air Force).

AAU. Administrative Area Unit (Army).

ACC. Army Chemical Center, Edgewood Arsenal, Maryland.

accelerometer. An instrument for determining the acceleration of the system with which it moves.

AD. Destroyer tender (Navy).

AEC. Atomic Energy Commission, Washington, D.C. Independent agency of the Federal government with statutory responsibilities for atomic energy matters. No longer exists; its functions have been assumed by the Department of Energy and the Nuclear Regulatory Commission.

AE. Store ship (Navy); also Air Force.

AFB. Air Force Base.

AFCRC. Air Force Cambridge Research Center.

AFDL. Small floating dry dock.

AFSWC. Air Force Special Weapons Center, Kirtland AFB, New Mexico.

AFSWP. Armed Forces Special Weapons Project.

AGC. Amphibious force flagship; later LCC.

airburst. The detonation of a nuclear device in the air at a height such that the expanding fireball does not touch the Earth's surface when the luminosity (emission of light) is at a maximum.

air particle trajectory. The direction, velocity, and rate of descent of windblown radioactive particles.

AK. Cargo ship.

AKA. Attack cargo ship; later LKA.

allowable dose. See MPE and MPL.

alpha emitter. A radionuclide that undergoes transformation by alpha-particle emission.

alpha particle. A charged particle emitted spontaneously from the nuclei of some radioactive elements. It is identical with a helium nucleus, having a mass of 4 units and an electric charge of 2 positive units. See also radioactivity.

alpha rays. A stream of alpha particles. Loosely, a synonym for alpha particles.

AMN. Airman; enlisted Air Force personnel.

AMS. Army Map Service, Washington, D.C.

AN/PDR-39. An ion-chamber-type survey meter; this was the standard radsafe meter. Others in use included the Navy version, the AN/PDR-T1B, the AN/PDR-18A and -18B, and lower range Geiger-Mueller instruments (AN/PDR-27, Beckman MX-5, and Nuclear Corporation 2610). Other radiac devices were also used.

AO. Oiler (Navy).

AOC. Air Operations Center.

AOG. Gasoline tanker.

AP. Transport ship.

APO. Army Post Office.

APD. High-speed transport ship.

APG. Aberdeen Proving Ground, Maryland.

ARA. Allied Research Associates, Boston, Massachusetts.

arming. The changing of a nuclear device from a safe condition (that is, a condition in which it cannot be accidentally detonated) to a state of readiness for detonation.

ARS. Salvage ship.

ARSD. Salvage lifting ship.

ASA. Army Security Agency.

ATA. Auxiliary ocean tug.

ATF. Fleet ocean tug.

atoll. A ring of coral reefs, usually with small islets, that surrounds a lagoon. Most are isolated reefs rising from the deep sea that have built up on submerged volcanoes. They vary considerably in size; the largest atoll, Kwajalein in the Marshall Islands, has an irregular shape that extends for 84 miles (135 km). See also coral reef.

atomic bomb (or weapon). A term sometimes applied to a nuclear weapon utilizing fission energy only. See also fission, nuclear device.

atomic explosion. See nuclear explosion.

attenuation. The process by which radiation is reduced in intensity when passing through some material. It is due to absorption or scattering or both, but it excludes the decrease of intensity with distance from the source (inverse square law), which see.

AU. Army Unit.

AV. Seaplane tender.

AVR. Aircraft rescue vessel.

AW. Distilling ship.

B-29. A 4-engine, propeller-driven bomber developed by Boeing, used for weather reconnaissance, cloud tracking, aerial sampling and photography, and aerial refueling at the PPG. These versions designated RB-29, WB-29, and KB-29.

B-36. A long-range, strategic bomber powered by six pusher propeller engines, supplemented by four jet engines. Developed by Consolidated Aircraft. Used as the subject of effects experiments and as a sampler controller aircraft. Also designated FB-36, RB-36, and WB-36.

B-47. A 6-jet-engine bomber with sweptback wings and a double-wheel bicycle landing gear, developed by Boeing. Used as the subject of effects experiments.

B-50. A 4-engine bomber developed by Boeing, with some features like those of the B-29, but having a taller tail fin and larger engines and nacelles.

B-57. U.S. version of English Electric Canberra bomber used as cloud sampling aircraft.

background radiation. The radiation of man's natural environment, consisting of that which comes from cosmic rays and from the naturally radioactive elements of the Earth, including that from within man's body. The term may also mean radiation extraneous to an experiment.

base surge. The particulate dust cloud that rolls out from the bottom of the cloud column produced by the detonation of a nuclear device. For underwater bursts, the base surge is a cloud of water droplets, and the flowing properties are those of a homogeneous liquid.

bathothermograph. A device for obtaining a record of temperature with depth in the upper 1,000 feet (300 meters) of the ocean, from a ship underway.

becquerel (Bq). See curie (Ci).

beta burns. Beta particles that come into contact with the skin and remain for an appreciable time can cause a form of radiation injury sometimes referred to as "beta burn." In an area of extensive early fallout, the whole surface of the body may be exposed to beta particles.

beta emitter. A radionuclide that disintegrates by beta particle emission. All beta-active elements existing in nature expel negative particles, i.e., electrons or, more exactly, negatrons. Beta-emitting particles are harmful if inhaled or ingested.

beta particle (ray). A charged particle of very small mass emitted spontaneously from the nuclei of certain radioactive elements. Most (if not all) of the direct fission products emit (negative) beta particles. Physically, the beta particle is identical to an electron moving at high velocity.

bhangmeter. A device that measures bomb yield based on light generated by the explosion.

blast. The detonation of a nuclear device, like the detonation of a high explosive such as TNT, results in the sudden formation of a pressure or shock wave, called a blast wave in the air and a shock wave when the energy is imparted to water or Earth.

blast wave. An air pulse in which the pressure increases sharply at the front accompanied by winds propagated from an explosion.

blast yield. That portion of the total energy of a nuclear explosion that manifests itself as blast and shock waves.

bomb debris. See weapon debris.

BRL. Ballistic Research Laboratories, Aberdeen Proving Ground, Maryland (Army).

BuMed. Bureau of Medicine and Surgery (Navy).

burst. Explosion; or detonation. See also air-burst, high-altitude burst, surface burst.

BuShips. Bureau of Ships (Navy).

C-47. A twin-engine transport aircraft manufactured by Douglas Aircraft Company (Air Force version of the DC-3).

- C-54. A 4-engine military cargo and personnel transport manufactured by Douglas Aircraft Company (Air Force version of the DC-4).
- cab. The shelter that covers a nuclear device being prepared for test. May be located on a tower, on the Earth's surface, or on a barge.
- Canberra. An RAF twin-turbojet, all-weather, tactical bomber developed by English Electric. Also built in the United States and used by the Air Force as the B-57.
- cathode-ray tube. A vacuum tube in which cathode rays (electrons) are beamed upon a fluorescent screen to produce a luminous image. The character of this image is related to, and controlled by, one or more electrical signals applied to the cathode-ray beam as input information. The tubes are used in measuring instruments such as oscilloscopes and in radar and television displays.
- cave. A heavily shielded enclosure in which radioactive materials can be remotely manipulated to avoid radiation exposure of personnel.
- CDC. Center for Disease Control.
- Ci; c. Abbreviation for curie, which see. Ci is preferred now but c was the abbreviation used in the 1950s.
- CIC. Counter-Intelligence Corps (Army).
Combat Intelligence Corps (Navy).
- CINCPAC. Commander in Chief of the Pacific.
- CJTJF 7. Commander, Joint Task Force 7.
- closed area. The land areas of Bikini and Enewetak and the water areas within 3 miles of them that the United States closed to unauthorized persons.
- cloud chamber effect. See Wilson cloud.
- cloud column (funnel). The visible column of weapon debris (and possibly dust or water droplets) extending upward from the point of a nuclear burst.
- cloud phenomena. See fallout, fireball, radioactive cloud.
- CNO. Chief of Naval Operations.
- collimate. To align nuclear weapon radiant outputs within an assigned solid angle through the use of baffles in order to enhance measurements.
- Co. Chemical symbol for cobalt.
- cobalt. Metallic element with radionuclide ^{60}Co used as calibration source for gamma instruments.
- ComAirPac. Commander Naval Air Force Pacific (Navy).
- ComServPac. Commander Service Forces Pacific (Navy).
- Condition "Purple". See Purple conditions.
- Consolidated List. Consolidated List of Radiological Exposures. The list that covers all recorded individual radiological exposures for joint task force participants.
- contamination. The deposit of radioactive material on the surfaces of structures, areas, objects, and personnel following a nuclear detonation. This material generally consists of fallout in which fission products and other device debris have become incorporated with particles of dust, vaporized components of device platforms, etc. Contamination can also arise from the radioactivity induced in certain substances by the action of neutrons from a nuclear explosion. See also decontamination, fallout, weapon debris.
- coral reef. A complex ecological association of bottom-living and attached shelled marine animal fossils that form fringing reefs, barrier reefs, and atolls. The lagoons of barrier reefs and atolls are important places for the deposition of fine-grained calcium carbonate mud.
- CPM. Counts per minute, a measure of radioactive material disintegration.
- crater. The depression formed in the surface of the Earth by a surface or underground explosion. Crater formation can occur by vaporization of the surface material, by the scouring effect of airblast, by throwout of disturbed material, or by subsidence.
- CRL. Chemical Research Laboratory (Army).
- Cs. Chemical symbol for cesium.
- C/S. Chief of Staff.
- CTG. Commander, Task Group.
- curie (Ci). A unit of radioactivity; it is the activity of a quantity of any radioactive species in which 3.700×10^{10} (37 billion) nuclear disintegrations occur per second (approximately the radioactivity of 1 gram of radium). The gamma curie is sometimes defined correspondingly as the activity of material in which this number of gamma-ray photons is emitted per second. This unit is being replaced by the becquerel (Bq), which is equal to one disintegration per second.
- cutie pie. A portable beta-gamma survey meter using an ionization chamber as the detector volume to measure radiation exposure. Usually used at higher radiation levels for both detecting and measuring ionizing radiation. A removable end-cap acts as a shield for the detector, allowing the instrument to indicate combined beta and gamma radiation when the cap is removed, or gamma radiation only when the cap is in place.

CVE. Escort aircraft carrier.

CW net. Carrier wave network. An organization of stations capable of direct radio communications on a common channel or frequency.

dan buoy. A floating temporary marker buoy such as one used in minesweeping and antisubmarine warfare operations.

D-day. The term used to designate the unnamed day on which a test takes place. The equivalent rule applies to H-hour. Time in plans is indicated by a letter which shows the unit of time employed in figures, with a minus or plus sign to indicate the amount of time before or after the reference event, e.g., D+7 means 7 days after D-day, H+2 means 2 hours after H-hour.

DDE. Escort destroyer.

DE. Destroyer escort.

debris (radioactive). See weapon debris.

decay (radioactive). The decrease in activity of any radioactive material with the passage of time due to the spontaneous emission from the atomic nuclei of either alpha or beta particles, sometimes accompanied by gamma radiation, or by gamma photons alone. Every decay process has a definite half-life.

decontamination. The reduction or removal of contaminating radioactive material from a structure, area, object, or person. Decontamination may be accomplished by (1) treating the surface to remove or decrease the contamination; (2) letting the material stand so that the radioactivity is decreased as a result of natural decay; and (3) covering the contamination in order to attenuate the radiation emitted.

device. Nuclear fission and fusion materials, together with their arming, fuzing, firing, chemical-explosive, and effects-measuring components, that have not reached the development status of an operational weapon.

diagnostic measurements or experiments. Experiments whose purpose is to study the explosive disassembly of a nuclear as opposed to effects measurements (which see).

DM. Minelayer destroyer. Converted destroyers designed to conduct high-speed minelaying operations.

DMA. The Division of Military Applications of the Atomic Energy Commission.

DOD. Department of Defense. The Federal executive agency responsible for the defense of the United States. Includes the four services and special joint defense agencies. Reports to the President through the Secretary of Defense.

dose. A general term denoting the quantity of ionizing radiation absorbed. The unit of absorbed dose is the rad (which see). In soft

body tissue the absorbed dose in rads is essentially equal to the exposure in roentgens. The biological dose (also called the RBE dose) in rems is a measure of biological effectiveness of the absorbed radiation. Dosage is used in older literature as well as exposure dose and simply exposure, and care should be exercised in their use. See also exposure.

dose rate. As a general rule, the amount of ionizing (or nuclear) radiation that an individual or material would receive per unit of time. It is usually expressed as rads (or rems) per hour or multiples or divisions of these units such as millirads per hour. The dose rate is commonly used to indicate the level of radioactivity in a contaminated area. See survey meter.

dosimeter. An instrument for measuring and registering the total accumulated dose of (or exposure to) ionizing radiation. Instruments worn or carried by individuals are called personnel dosimeters.

dosimetry. The measurement and recording of radiation doses and dose rates. It is concerned with the use of various types of radiation instruments with which measurements are made. See also dosimeter, survey meter.

DPM. Disintegrations per minute, a measure of radioactivity, literally atoms disintegrating per minute. Difficult to directly compare with roentgens per hour for mixtures of radio-nuclides.

drogue. A sea anchor or similar drag device used to pull out a parachute.

DTMB. David Taylor Model Basin, Carderock, Maryland (Navy).

DUKW. Two-and-one-half-ton amphibious truck.

dynamic pressure. Air pressure that results from the mass air flow (or wind) behind the shock front of a blast wave.

effects measurements or experiments. Experiments whose purpose is to study what a nuclear explosion does to equipment and systems. Includes also measurement of the changes in the environment caused by the detonation such as increased air pressures (blast), thermal and nuclear radiation, cratering, water waves, etc.

EG&G. Edgerton, Germeshausen & Grier, Boston, Massachusetts (now EG&G, Inc.). An AEC contractor. Provided timing and firing electronics and technical film coverage.

electromagnetic radiation. Electromagnetic radiations range from X-rays and gamma rays of short wave length (high frequency), through the ultraviolet, visible, and infrared regions, to radar and radio waves of relatively long wavelength.

electron. A particle of very small mass and electrically charged. As usually defined, the electron's charge is negative. The term negatron is also used for the negative electron and the positively charged form is called a positron. See also beta particles.

EODU. Explosive Ordnance Disposal Unit (Navy).

ETA. Estimated time of arrival.

ETD. Estimated time of departure.

exposure. A measure expressed in roentgens of the ionization produced by gamma rays (or X-rays) in air. The exposure rate is the exposure per unit time (e.g., roentgens per hour). See dose, dose rate, roentgen.

exposure rate contours. Lines joining points which have the same radiation intensity that define a fallout pattern, represented in terms of roentgens per hour.

F4U. Propeller-driven fighter aircraft developed by Chance-Voight Aircraft Company. Called the Cosair.

F-84G. Single-engine jet fighter developed by Republic Aircraft and used from IVY (1952) through REDWING (1956) as cloud sampler aircraft.

fallout. The process or phenomenon of the descent to the Earth's surface of particles contaminated with radioactive material from the radioactive cloud. The term is also applied in a collective sense to the contaminated particulate matter itself. The early (or local) fallout is defined, somewhat arbitrarily, as particles reaching the Earth within 24 hours after a nuclear explosion. The delayed (or worldwide) fallout consists of the smaller particles, which ascend into the upper troposphere and stratosphere and are carried by winds to all parts of the Earth. The delayed fallout is brought to Earth, mainly by rain and snow, over extended periods ranging from months to years.

fathometer. A depth-sounding instrument. The depth of water is measured by noting the time the echo of a sound takes to return from the bottom.

FEAF. Far East Air Forces.

film badges. Used for the indirect measurement of ionizing radiation. Generally contain two or three pieces of film of different radiation sensitivities. They are wrapped in paper (or other thin material) that blocks light but is readily penetrated by gamma rays. The films are developed and the degree of fogging (or blackening) observed is a measure of the gamma-ray exposure, from which the absorbed dose is calculated. Film badges can also measure beta and neutron radiation.

fireball. The luminous sphere of hot gases that forms a few millionths of a second after a nuclear explosion as the result of the absorption by the surrounding medium of the thermal X-rays emitted by the extremely hot (several tens of millions of degrees) device residues. The exterior of the fireball in air is initially sharply defined by the luminous shock front and later by the limits of the hot gases themselves.

fission. The process of the nucleus of a particular heavy element splitting into two nuclei of lighter elements, with the release of substantial amounts of energy. The most important fissionable materials are uranium-235 and plutonium-239; fission is caused by the absorption of neutrons.

fission detectors. Radiation pulse detector of the proportional counter type in which a foil or film of fissionable materials is incorporated to make it respond to neutrons.

fission products. A general term for the complex mixture of substances produced as a result of nuclear fission. A distinction should be made between these and the direct fission products or fission fragments that are formed by the actual splitting of the heavy-element nuclei into nuclei of medium atomic weight. Approximately 80 different fission fragments result from roughly 40 different modes of fission of a given nuclear species (e.g., uranium-235 or plutonium-239). The fission fragments, being radioactive, immediately begin to decay, forming additional (daughter) products, with the result that the complex mixture of fission products so formed contains over 300 different radionuclides of 36 elements.

fixed alpha. Alpha radioactivity that cannot be easily removed as evidenced by no measured change in a swipe of a 100-cm² area.

fluorescence. The emission of light (electromagnetic radiation) by a material as a result of the absorption of energy from radiation. The term may refer to the radiation emitted, as well as to the emission process.

forward area. The PPG and adjoining areas (e.g., Kwajalein).

FPO. Fleet Post Office.

fusion. The combination of two light nuclei to form a heavier nucleus, with the release of the difference of the nuclear binding energy of the fusion products and the sum of the binding energies of the two light nuclei.

gamma rays. Electromagnetic radiations of high photon energy originating in atomic nuclei and accompanying many nuclear reactions (e.g., fission, radioactivity, and neutron capture). Physically, gamma rays are identical with X-rays of high energy; the only essential difference is that X-rays do not originate from

atomic nuclei of high energy. Gamma rays can travel great distances through air and can penetrate considerable thickness of material, although they can neither be seen nor felt by human beings except at very high intensities, which cause an itching and tingling sensation of the skin. They can produce harmful effects even at a long distance from their source (The Effects of Nuclear Weapons, 3rd edition).

Geiger-Mueller counter. A gas discharge pulse counter for ionizing radiation. See also AN/PDR-39 and ion-chamber-type survey meter.

GMT. Greenwich Mean Time.

gray (Gy). A recently introduced ICRP term; 1 Gy equals 100 rad.

ground zero (GZ). The point on the surface of land or water at, or vertically below or above, the center of the burst of a nuclear weapon.

gunk. A viscous commercial preparation that is soluble both in water and petroleum derivatives. It acts as a wetting agent in removing grease and particulate matter from metal and other nonporous surfaces.

H-19. Large utility helicopter manufactured by Sikorsky Aircraft Division of United Aircraft Corporation.

H-hour. Time zero, or time of detonation. When used in connection with planning operations it is the specific hour on which the operation event commences. See D-day.

half-life. The time required for a radioactive material to lose half of its radioactivity due to decay. Each radionuclide has a unique half-life.

HASL, NYKOPO. Atomic Energy Commission's Health and Safety Laboratory, New York Operations Office.

HE. High explosive.

HF. High-frequency radio communications. The HF band is from 3 to 30 kHz.

high-altitude burst. Defined, somewhat arbitrarily, as a detonation in or above the stratosphere. The distribution of the energy of the explosion between blast and thermal radiation changes appreciably with increasing altitude.

HMR. Marine Helicopter Transport Squadron.

hodograph. A common hodograph in meteorology represents the speed and direction of winds at different altitude increments.

hot; hot spot. Commonly used colloquial term meaning a spot or area relatively more radioactive than some adjacent area.

HRS-2. Transport helicopter manufactured by Sikorsky Aircraft Company.

IBDA. Indirect Bomb Damage Assessment. A revised target analysis based on new data such as actual weapon yield, burst height, and ground zero obtained by means other than direct assessment.

ICRP. International Commission on Radiological Protection.

initial radiation. Also known as prompt radiation. Electromagnetic radiations of high energy emitted from both the fireball and the radioactive cloud within the first minute after a detonation. It includes neutrons and gamma rays given off almost instantaneously, as well as the gamma rays emitted by the fission products and other radioactive species in the rising cloud. Initial radiations from ground or near-ground bursts activate both Earth materials and device debris to create contamination.

inverse square law. The decrease in radiation intensity with distance from a single-point source is in proportion to the square of the distance removed.

ion-chamber-type survey meter. A device for measuring the amount of ionizing radiation. Consists of a gas-filled chamber containing two electrodes (one of which may be the chamber wall) between which a potential difference is maintained. The radiation ionizes gas in the chamber and an instrument connected to one electrode measures the ionization current produced.

ionization. The process of adding electrons to, or knocking electrons from, atoms or molecules, thereby creating ions. High temperatures, electrical discharges, and nuclear radiation can cause ionization.

ionizing radiation. Any particulate or electromagnetic radiation capable of producing ions, directly or indirectly, in its passage through matter. Alpha and beta particles produce ion pairs directly, while gamma rays and X-rays liberate electrons as they traverse matter, which in turn produce ionization in their paths.

ionosphere. The region of the atmosphere, extending from roughly 40 to 250 miles (64 to 400 km) above the Earth, in which there is appreciable ionization. The presence of charged particles in this region profoundly affects the propagation of radio and radar waves.

irradiation. Exposure of matter to radiation.

isodose lines. Dose or dose-rate contours. In fallout, contours plotted on a radiation field within which the dose rate or the total accumulated dose is the same.

isotope. Atoms with the same atomic number (same chemical element) but different atomic weight; i.e., the nuclei have the same number of protons but a different number of neutrons.

JCS. Joint Chiefs of Staff.

JTF 132. Joint Task Force 132 was a combined force of personnel of the Department of Defense (Air Force, Army, Marine Corps, Navy), the AEC, and their contractors. JTF 132 was responsible for all aspects of nuclear weapon tests in the Pacific testing area during 1952.

KB-29. Aerial tanker based on the B-29.

kinetic energy. Energy associated with the motion of matter.

L-20. Single-engine, 2-place light aircraft used in Enewetak airlift.

LASL. Los Alamos Scientific Laboratory, Los Alamos, New Mexico.

LCM. Landing craft, mechanized.

LCP(L). Landing craft, personnel (large).

LCP(R). Landing craft, personnel (ramp).

LCT. Landing craft, tank.

LCU. Utility landing craft.

LML. Lookout Mountain Laboratory, Hollywood, California (Air Force).

Loran. Long-range aid to navigation system. Loran stations were maintained by the U.S. Coast Guard Station on Enewetak Island and Johnston Atoll.

LSD. Landing ship, dock.

LSIL. Landing ship, infantry (large).

LST. Landing ship, tank.

magnetometer. An instrument for measuring changes in the geomagnetic field.

MATS. Military Air Transport Service; later, Military Airlift Command (joint Air Force).

megaton (energy). Approximately the amount of energy that would be released by the explosion of one million tons of TNT.

microcurie. One-millionth of a curie.

micron. One-millionth of a meter (i.e., 10^{-6} meter or 10^{-4} centimeter); it is roughly four one-hundred-thousandths (4×10^{-5}) of an inch.

milliroentgen. One-thousandth of a roentgen.

MPE. Maximum Permissible Exposure (rule dose). That exposure to ionizing radiation that is established by authorities as the maximum over certain periods without resulting in undue risk to human health.

MPL. Maximum Permissible Limit. That amount of radioactive material in air, water, foodstuffs, etc. that is established by authorities as the maximum that would not create undue risk to human health.

mR; mr. Abbreviation for milliroentgen.

MSTS. Military Sea Transportation Service, (Navy).

mushroom cap. Top of the cloud formed from the fireball of a nuclear detonation.

MV. Motor vessel.

MWB. Motor whale boat.

NAS. Naval Air Station.

NAVAID. B-29s and B-36s equipped with navigational and homing electronics for the purpose of providing assistance to the smaller, less well equipped F-84G samplers.

NBS. National Bureau of Standards.

NCO. Noncommissioned officer.

NCRP. National Committee on Radiation Protection and Measurements. Before 1956 simply the National Committee on Radiation Protection.

NEL. Naval Electronics Laboratory.

neutron. A neutral elementary particle (i.e., with neutral electrical charge) of approximately unit mass (i.e., the mass of a proton) that is present in all atomic nuclei, except those of ordinary (light) hydrogen. Neutrons are required to initiate the fission process, and large numbers of neutrons are produced by both fission and fusion reactions in nuclear explosions.

neutron flux. The intensity of neutron radiation. It is expressed as the number of neutrons passing through 1 cm^2 in 1 second.

NPG. Nevada Proving Ground, now the Nevada Test Site (NTS).

NRDL. Naval Radiological Defense Laboratory.

NRL. Naval Research Laboratory.

NSC, TI. Naval Schools Command, Treasure Island, California.

NTPR. Nuclear Test Personnel Review.

NTS. Nevada Test Site.

nuclear cloud. See radioactive cloud.

nuclear device (or weapon or bomb). Any device in which the explosion results from the energy released by reactions involving atomic nuclei, either fission or fusion, or both. Thus, the

A- (or atomic) bomb and the H- (or hydrogen) bomb are both nuclear weapons. It would be equally true to call them atomic weapons, since the energy of atomic nuclei is involved in each case. However, it has become more or less customary, although it is not strictly accurate, to refer to weapons in which all the energy results from fission as A-bombs. In order to make a distinction, those weapons in which part of the energy results from thermonuclear (fusion) reactions of the isotopes of hydrogen have been called H-bombs or hydrogen bombs.

nuclear explosion. Explosive release of energy due to the splitting, or joining, of atoms. The explosion is observable by a violent emission of ultraviolet, visible, and infrared (heat) radiation, gamma rays, neutrons, and other particles. This is accompanied by the formation of a fireball. A large part of the energy from the explosion is emitted as blast and shock waves when detonated at the Earth's surface or in the atmosphere. The fireball produces a mushroom-shaped mass of hot gases and debris, the top of which rises rapidly. See also radiation, gamma rays, fireball, nuclear weapon, fission, fusion, blast.

nuclear fusion. See thermonuclear fusion.

nuclear radiation. Particulate and electromagnetic radiation emitted from atomic nuclei in various nuclear processes. The important nuclear radiations, from the weapons standpoint, are alpha and beta particles, gamma rays, and neutrons. All nuclear radiations are ionizing radiations, but the reverse is not true; X-rays, for example, are included among ionizing radiations, but they are not nuclear radiations since they do not originate from atomic nuclei.

nuclear tests. Tests carried out to supply information required for the design and improvement of nuclear weapons and to study the phenomena and effects associated with nuclear explosions.

nuclide. Any species of atom that exists for a measurable length of time. The term nuclide is used to describe any atomic species distinguished by the composition of its nucleus; i.e., by the number of protons and the number of neutrons. Isotopes of a given element are nuclides having the normal number of protons but different numbers of neutrons in this nuclei. A radionuclide is a radioactive nuclide.

NYKOPO. New York Operations Office (Atomic Energy Commission).

off-scale. Radiation (or other physical phenomena) greater than the capacity of a measuring device to measure.

ONR. Office of Naval Research, Washington, D.C.

ORNL. Oak Ridge National Laboratory, Tennessee.

oscilloscope. The name generally applied to a cathode-ray device.

overpressure. The transient pressure, usually expressed in pounds per square inch, exceeding the ambient pressure, manifested in the shock (or blast) wave from an explosion.

P2V. Twin-engine patrol bomber used for maritime patrol and antisubmarine warfare. Developed by Lockheed for the U.S. Navy. Used in nuclear tests as controller and transient ship search.

PC. Patrol craft.

peak overpressure. The maximum value of the overpressure (which see) at a given location.

permissible contamination or dose. That dose of ionizing radiation that is not expected to cause appreciable bodily injury to a person at any time during his lifetime.

phantom. A volume of material closely approximating the density and effective atomic number of tissue. The phantom absorbs ionizing radiation in the same manner as tissue, thus radiation dose measurements made within the phantom provide a means of approximating the radiation dose within a human or animal body under similar exposure conditions. Materials commonly used for phantoms are water, masonite, pressed wood, and beeswax.

pig. A heavily shielded container (usually lead) used to ship or store radioactive materials.

POL. Petroleum, oil, and lubricants. The storage area for these products is referred to as a POL farm.

PPG. Pacific Proving Ground (after 1956 designated the Eniwetok Proving Ground, or EPG).

prompt radiation. See initial radiation.

proton. A particle carrying a positive charge and physically identical to the nucleus of the ordinary hydrogen atom.

Purple conditions. A shipboard warning system used in radiological defense. Various numbered conditions were sounded when radioactive fallout was encountered. Responses to the sounded warnings included closing of various hatches and fittings, turning off parts of the ventilation system, and removing personnel from a ship's open decks. The higher the Purple condition number, the more severe the radiological situation.

"Q"-clearance. A security clearance granted by the Atomic Energy Commission, based upon an investigation conducted by the FBI.

R; r. Symbol for roentgen.

R5D. Four-engine propeller transport manufactured by the Douglas Aircraft Company for the Navy and the Air Force, where it was designated C-54. Commercial versions were designated DC-4.

Ra. Chemical symbol for radium.

rad. Radiation absorbed dose. A unit of absorbed dose of radiation; it represents the absorption of 100 ergs of ionizing radiation per gram (or 0.01 J/kg) of absorbing material, such as body tissue. This unit is presently being replaced in scientific literature by the Gray (Gy), numerical equal to the absorption of 1 joule of energy per kilogram of matter.

RadDefense. Radiological defense. Defense against the effects of radioactivity from atomic weapons. It includes the detection and measurement of radioactivity, the protection of persons from radioactivity, and decontamination of areas, places, and equipment. See also radsafe.

radex area. Radiological exclusion area. Following each detonation there were areas of surface radiological contamination and areas of air radiological contamination. These areas were designated as radex areas. Radex areas were used to chart actual or predicted fallout and also used for control of entry and exit.

radiac. Radiation detection, indication, and computation.

radiation. The emission of any rays, electromagnetic waves, or particles (e.g., gamma rays, alpha particles, beta particles, neutrons) from a source.

radiation decay. See decay (radioactive).

radiation detectors. Any of a wide variety of materials or instruments that provide a signal when stimulated by the passage of ionizing radiation; the sensitive element in radiation detection instruments. The most widely used media for the detection of ionizing radiation are photographic film and ionization of gases in detectors (e.g., Geiger counters), followed by materials in which radiation induces scintillation.

radiation exposure. Exposure to radiation may be described and modified by a number of terms. The type of radiation is important: alpha and beta particles, neutrons, gamma rays and X-rays, and cosmic radiation. Radiation exposure may be from an external radiation source, such as gamma rays, X-rays, or neutrons, or it may be from radionuclides retained within the body emitting alpha, beta, or gamma radiation. The exposure may result from penetrating or nonpenetrating radiation in relation to its ability to enter and pass through matter -- alpha and beta particles being considered as nonpenetrating and other types of radiation as penetrating. Exposure may be related to a part of the body or to the whole body. See also whole body irradiation.

radiation intensity. Degree of radiation. Measured and reported in roentgens (R), rads, rems, and rep, multiples and divisions of these units, and multiples and divisions of these units as a function of exposure rate (per hour, day, etc.).

radioactive (or nuclear) cloud. An all-inclusive term for the cloud of hot gases, smoke, dust, and other particulate matter from the weapon itself and from the environment, which is carried aloft in conjunction with the rising fireball produced by the detonation of a nuclear weapon.

radioactive nuclide. See radionuclide.

radioactive particles. See radioactivity.

radioactive pool. A disk-like pool of radioactive water near the surface formed by a water-surface or subsurface detonation. The pool gradually expands into an annular form, then reverts to a larger irregular disk shape at later times with a corresponding attenuation of radioactivity.

radioactivity. The spontaneous emission of radiation, generally alpha or beta particles, often accompanied by gamma rays, from the nuclei of an (unstable) nuclide. As a result of this emission the radioactive nuclide is converted (decays) into the isotope of a different (daughter) element, which may (or may not) also be radioactive. Ultimately, as a result of one or more stages of radioactive decay, a stable (nonradioactive) end product is formed.

radiological survey. The directed effort to determine the distribution and dose rate of radiation in an area.

radionuclide. A radioactive nuclide (or radioactive atomic species).

radiosonde. A balloon-borne instrument for the simultaneous measurement and transmission of meteorological data, consisting of transducers for the measurement of pressure, temperature, and humidity; a modulator for the conversion of the output of the transducers to a quantity that controls a property of the radiofrequency signal; a selector switch, which determines the sequence in which the parameters are to be transmitted; and a transmitter, which generates the radiofrequency carrier.

radiosonde balloon. A balloon used to carry a radiosonde aloft. These balloons have daytime bursting altitudes of about 80,000 feet (25 km) above sea level. The balloon measures about 5 feet (1.5 meters) in diameter when first inflated and may expand to 20 feet (6 meters) or more before bursting at high altitude.

radium. A radioactive element with the atomic number 88 and an atomic weight of 226. In nature, radium is found associated with uranium, which decays to radium by a series of alpha and beta emissions. Radium is used as a radiation source for instrument calibration.

radsafe. Radiological safety. General term used to cover the training, operations, and equipment used to protect personnel from potential overexposures to nuclear radiation during nuclear tests.

rainout. Removal of radioactive particles from a nuclear cloud by rain.

rawin. Radar wind sounding tests that determine the winds aloft patterns by radar observation of a balloon.

rawinsonde. Radar wind sounding and radiosonde (combined).

Raydist Corporation. A Norfolk, Virginia firm that provided navigational aid service for test aircraft in the Bikini area during weapon tests in the Pacific Proving Ground.

Raydist slave stations. Support instrumentation used in the positioning of experimental effects aircraft.

RB-29. Reconnaissance version of the B-29.

RB-36. Reconnaissance version of the B-36.

RBE. Relative biological effectiveness. A factor used to compare the biological effectiveness of absorbed radiation doses (i.e., rads) due to different types of ionizing radiation. For radiation protection the term has been superseded by Quality Factor.

rem. A special unit of biological radiation dose equivalent; the name is derived from the initial letters of the term "roentgen equivalent man (or mammal)." The number of rems of radiation is equal to the number of rads absorbed multiplied by the RBE of the given radiation (for a specified effect). The rem is also the unit of dose equivalent, which is equal to the product of the number of rads absorbed multiplied by the "quality factor" and distribution factor for the radiation. The unit is presently being replaced by the sievert (Sv).

rep. An obsolete special unit of absorbed dose.

residual nuclear radiation. Nuclear radiation, chiefly beta particles and gamma rays, that persists for a time following a nuclear explosion. The radiation is emitted mainly by the fission products and other bomb residues in the fallout, and to some extent by Earth and water constituents, and other materials, in which radioactivity has been induced by the capture of neutrons.

R-hour. Reentry hour.

roentgen. (R; r) A special unit of exposure to gamma (or X-) radiation. It is defined precisely as the quantity of gamma (or X-) rays that will produce electrons (in ion pairs) with a total charge of 2.58×10^{-4} coulomb in 1 kilogram of dry air under standard conditions. An exposure of 1 roentgen results in the deposition of about 94 ergs of energy in 1 gram of soft body tissue. Hence, an exposure of 1 roentgen is approximately equivalent to an absorbed dose of 1 rad in soft tissue.

RSSU. Radiological Safety Support Unit (Army).

SA-16. Air Force general purpose amphibian for air-sea rescue work. Manufactured by Grumman Aircraft Engineering Corporation, New York. Redesignated UY-16.

SAC. Strategic Air Command (Air Force).

sampler aircraft. Aircraft used for collection of gaseous and particulate samples from nuclear clouds to determine the level of radioactivity or the presence of radioactive substances.

SAR. Search and rescue operations.

SC. Sandia Corporation, Albuquerque, New Mexico.

scattering. The diversion of radiation (thermal, electromagnetic and nuclear) from its original path as a result of interactions (or collisions) with atoms, molecules, or larger particles in the atmosphere or other media between the source of the radiations (e.g., a nuclear explosion) and a point some distance away. As a result of scattering, radiations (especially gamma rays and neutrons) will be received at such a point from many directions instead of only from the direction of the source. See also skyshine.

SCEL. Signal Corps Engineering Laboratories, Ft. Monmouth, New Jersey (Army).

scintillation. A flash of light produced by ionizing radiation in a fluor or a phosphor, which may be crystal, plastic, gas, or liquid.

seamount. A submarine mountain rising above the deep sea floor, commonly from 3,000 to 10,000 feet (1 to 3 km) and having the summit 1,000 to 6,000 feet (0.3 to 1.8 km) below sea level.

shear (wind). Refers to differences in direction (directional shear) of wind at different altitudes.

shielding. Any material or obstruction that absorbs (or attenuates) radiation and thus tends to protect personnel or equipment from the effects of a nuclear explosion. A moderately thick layer of any opaque material will provide satisfactory shielding from thermal radiation, but a considerable thickness of material of high density may be needed for gamma radiation shielding. See also attenuation.

shock. Term used to describe a destructive force moving in air, water, or Earth caused by detonation of a nuclear detonation.

shock wave. A continuously propagated pressure pulse (or wave) in the surrounding medium, which may be air, water, or Earth, initiated by the expansion of the hot gases produced in an explosion.

sievert (Sv). A recently introduced ICRP measure of "dose equivalent" that takes into account the "quality factor" of different sources of ionizing radiation. One sievert equals 100 rem.

SIO. Scripps Institution of Oceanography, La Jolla, California.

skyshine. Radiation, particularly gamma rays from a nuclear detonation, reaching a target from many directions as a result of scattering by the oxygen and nitrogen in the intervening atmosphere.

slant range. The straight-line distance of an aircraft at any altitude from ground zero or the distance from an airburst to a location on the ground.

SRI. Stanford Research Institute, Stanford, California.

stratosphere. Upper portion of the atmosphere, approximately 7 to 40 miles (11 to 64 km) above the Earth's surface, in which temperature changes but little with altitude and cloud formations are rare.

streamline. In meteorology, the direction of the wind at any given time.

surface burst. A nuclear explosion on the land surface, an island surface or reef, or on a barge.

surface zero. See ground zero. Also the location on the ground surface directly above an underground zero point.

survey meters. Portable radiation detection instruments especially adapted for surveying or inspecting an area to establish the existence and amount of radiation present, usually from the standpoint of radiological protection. Survey instruments are customarily powered by self-contained batteries and are designed to respond quickly and to indicate directly the exposure rate conditions at the point of interest. See AN/PDR-36, Geiger-Mueller counter, and ion-chamber-type survey meter.

survey, radiation. Evaluation of the radiation hazards associated with radioactive materials.

T-AP. Personnel transport (Military Sea Transportation Service).

TAU. Test Aircraft Unit.

TBM. Single-engine, propeller-driven torpedo bomber developed by Grumman Aircraft. Converted to a carrier-based transport and used in this way at IVY.

TBU. Test Base Unit.

TDY. Temporary duty assignment.

TG. Task Group.

TE. Task Element.

thermal radiation. Electromagnetic radiation emitted in two pulses from a surface or airburst from the fireball as a consequence of

its very high temperature; it consists essentially of ultraviolet, visible, and infrared radiation. In the first pulse, when the temperature of the fireball is extremely high, ultraviolet radiation predominates; in the second pulse, the temperatures are lower and most of the thermal radiation lies in the visible and infrared regions of the spectrum.

thermonuclear fusion. Refers to the processes in which very high temperatures are used to bring about the fusion of light nuclei, such as those of the hydrogen isotopes (deuterium and tritium), with the accompanying liberation of energy. The high temperatures required to initiate the fusion reaction are obtained by means of a fission explosion. See also fusion.

TNT equivalent. A measure of the energy released as the result of the detonation of a nuclear device or weapon, expressed in terms of the mass of TNT that would release the same amount of energy when exploded. The TNT equivalent is usually stated in kilotons (1,000 tons) or megatons (1 million tons). The basis of the TNT equivalence is that the explosion of 1 ton of TNT is assumed to release 1 billion calories of energy. See also megaton, yield.

trapped radiation. Electrically charged particles moving back and forth in spirals along the north-south orientation of the Earth's magnetic field between mirror points, called conjugate points. Negatively charged particles drift eastward as they bounce between northern and southern conjugate points and positively charged particles drift westward, thus forming shells or belts of radiation above the Earth. The source of the charged particles may be natural, from solar activity (often called Van Allen belts), or artificial, resulting from high-altitude nuclear detonations.

tropopause. The boundary dividing the stratosphere from the lower part of the atmosphere, the troposphere. The tropopause normally occurs at an altitude of about 25,000 to 45,000 feet (7.6 to 13.7 km) in polar and temperate zones, and at 55,000 feet (16.8 km) in the tropics. See also stratosphere, troposphere.

troposphere. The region of the atmosphere, immediately above the Earth's surface and up to the tropopause, in which the temperature falls fairly regularly with increasing altitude, clouds form, convection is active, and mixing is continuous and more or less complete.

Trust Territory. The Marshall Islands were Trust Territories under the jurisdiction of the United Nations. Assigned by the United Nations to the United States in trust for administration, development, and training.

TU. Task Unit.

TSU. Test Services Unit.

TSUP. Test Support Unit (Provisional).

TWX. Teletypewriter exchange.

type commander. The officer or agency having cognizance over all Navy ships of a given type. This is in addition to the particular ship's assignment in a task force, fleet, or other tactical subdivision.

UCLA. University of California, Los Angeles.

UCRL. University of California Radiation Laboratory, Livermore, California.

UF-1. The Navy designation for the SA-16A.

UHF. Ultra-high frequency.

ultraviolet. Electromagnetic radiation of wavelengths between the shortest visible violet (about 3,850 angstroms) and soft X-rays (about 100 angstroms).

USFS. U.S. Forest Service.

USNS. United States Navy Ship; vessels of this designation are manned by civilian crews.

VA. Veterans Administration.

VC. Fleet composite squadron (formerly VU).

versene. A detergent.

VHF. Very-high-frequency radio communications. The VHF band is from 30 to 300 kHz.

Viking. Radio call sign of VIP aircraft.

VP. Aviation patrol squadron (Navy).

VR. Air transport squadron (Navy).

WADC. Wright Air Development Center, Wright-Patterson AFB, Ohio (Air Force).

warhead. The portion of the missile or bomb containing the nuclear device.

WASP. Five-inch shells fired to spread radar-trackable material (window) to study high-altitude winds.

WB-29. Weather reconnaissance version of B-29 used for cloud tracking and sampling.

weapon debris. The radioactive residue of a nuclear device after it has been detonated, consisting of fission products, various products of neutron capture, weapon casing and other components, and uranium or plutonium that has escaped fission.

whole body irradiation. Exposure of the body to ionizing radiation from external radiation sources. Critical organs for the whole body are the lens of the eye, the gonads, and the red-blood-forming marrow. As little as only 1 cm³ of bone marrow constitutes a whole-body

exposure. Thus, the entire body need not be exposed to be classed as a whole-body exposure.

Wilson cloud. A mist or fog of minute water droplets that temporarily surrounds a fireball following a nuclear detonation in a humid atmosphere. This is caused by a sudden lowering of the pressure (and temperature) after the passing of the shock wave (cloud chamber effect) and quickly dissipates as temperatures and pressures return to normal.

window. See WASP.

worldwide fallout. Consists of the smaller radioactive nuclear detonation particles that ascend into the upper troposphere and the stratosphere and are carried by winds to all parts of the Earth. The delayed (or worldwide) fallout is brought to Earth, mainly by rain and snow, over extended periods ranging from months to years.

WT. Prefix of Weapon Test (WT) report identification numbers. These reports were prepared to record the results of scientific experiments.

YAG. Miscellaneous auxiliary ship (Navy).

YC. Open lighter (non-self-propelled; Navy).

YCV. Aircraft transportation lighter; non-self-propelled (Navy).

YFN. Covered lighter (non-self-propelled; Navy).

YFNB. Larger covered lighters (Navy).

yield. The total effective energy released in a nuclear detonation. It is usually expressed in terms of the equivalent tonnage of TNT required to produce the same energy release in an explosion. The total energy yield is manifested as nuclear radiation (including residual radiation), thermal radiation, and blast and shock energy, the actual distribution depending upon the medium in which the explosion occurs and also upon the type of weapon. See TNT equivalent.

yield (blast). That portion of the total energy of a nuclear detonation that is identified as the blast or shock wave.

yield (fission). That portion of the total explosive yield attributable to nuclear fission, as opposed to fusion. The interest in fission yield stems from the interest in fission product formation and its relationship to radioactive fallout.

YO. Fuel oil barge; self-propelled.

YOG. Gasoline barge; self-propelled.

YOGN. Gasoline barge; non-self-propelled.

YON. Oil storage barge (non-self-propelled).

ZI. Zone of Interior (conterminous United States).

APPENDIX E

INDEX OF PARTICIPATING ORGANIZATIONS

- Aeronautical Ice Research Laboratory. 163.
- USS Agawam (AOG-6). Operations: 50, 51, 61, 215, 226-228, 230-232; Experimental Activity: 34, 153, 222; In Fallout: 187,200; Personnel Exposures: 217; Position Data: 183, 201 (Figure 25).
- Air Defense Command (Air Force). 175, 240.
- Air Department Rendova, Marine Component. Operations: 51, 110, 125, 232, 248-249; Personnel Exposures: 233.
- Air Force. 4, 238-247, 258; see also entries under individual Air Force units.
- Air Force Cambridge Research Center (AFCRC). 119-121, 163, 164. 240-241, 245.
- Air Force Special Weapons Center (AFSWC). Cloud Sampling: 81, 96; Number of Personnel at the PPG: 240, 244.
- Air Force Weapons Laboratory (AFWL). 7.
- Air Materiel Command (Air Force). 97, 101.
- Air Research and Development Command (ARDC) (Air Force). 24.
- Air Training Command (Air Force). 175, 240.
- Air Transport Squadron-3 (VR-3) (Navy). 216, 218, 234.
- Air Transport Squadron-8 (VR-8) (Navy). 218, 235.
- Allied Research Associates (ARA). 162, 251, 252.
- American Car & Foundry Company (ACF). 119-121, 177, 252.
- American Red Cross. 251, 253.
- USS Arikara (ATF-98). Operations: 50, 51, 62, 159, 160, 226-228, 236; Experimental Activities: 222; Involvement with Radioactivity: 229; Personnel Exposures: 217; MIKE Position: 183.
- Armed Forces Special Weapons Project (AFSWP). Radsafe Instrumentation: 91; Radsafe Activities: 176; Planning for JTF 132: 37; Role in Planning: 118; Project activities: 164; Personnel Badged: 250; Personnel Exposures: 251.
- Army. 4, 209-213, 258; see also entries under individual Army units.
- Army Chemical Corps School. 210, 211.
- Army Signal Corps. 91, 165.
- Artillery School, Ft. Sill (Army). 210, 211.
- Atomic Energy Commission (AEC). Interest in Test Program: 22, 36, 56, 119-121, 134, 250; Interest in PPG: 31-33, 42; And JTF 132: 34, 38 (Figure 5), 40; Radiation Standards: 84-86, 88-90; Rad-safe Procedures: 103.
- MV Spencer F. Baird. Operations: 50, 62, 173, 222, 236, 239; KING Position: 201 (Figure 25).
- Bell Laboratories. 160.
- Bendix Aviation. 164, 253.
- Bergstrom AFB. 244.
- Boeing Aircraft Company. 162, 253.
- Bryan AFB. 240.
- Bureau of Medicine (Navy). 84.
- Bureau of Ships (BuShips) (Navy). 95, 152, 254, 217, 219.
- Cambridge Corporation. 56, 119-121, 253.
- USS Carpenter (DDE-825). Operations: 50, 51, 62, 153, 190, 198, 221, 229-232, 236; Experimental Activities: 34, 222; Personnel Exposures: 218; Position Data: 183, 201 (Figure 25).
- Center for Disease Control (CDC). 5.
- Chanute AFB. 240.
- Chemical and Radiological Labs, Army Chemical Center (ACC). 154, 155, 210, 211.
- USS Collett (DD-730). 221.
- USNS General E.T. Collins (T-AP-147). Operations: 50, 51, 61, 178-181, 194, 200, 215, 224-226, 230-232, 235; Position Data: 183, 201 (Figure 25).
- Commander Naval Air Forces Pacific (ComNavAirPac). 175, 217, 220.
- Commander in Chief Atlantic Fleet (CINCLANT). 175, 217, 220.
- Commander in Chief Pacific (CINCPAC). 37, 38, 40, 65, 76, 217, 220.
- Composite Squadron 3 (VC-3) (Navy). 51, 216, 232, 233.
- Consolidated Vultee Aircraft Company. 162, 253.

Counterintelligence Corps, Subdetachment C (Army). 47, 211.

USS Curtiss (AV-4). Operations: 50-55; 199, 201, 215, 221, 223, 236; Experimental Activities: 34, 140, 157, 159, 160, 222; Personnel Exposures: 217; MIKE Position: 183.

Davis-Monthan AFB. 242.

Department of State. 103.

Division of Biology and Medicine (AEC). 83, 84, 88, 89.

Division of Military Applications (AEC). 32.

Drilling and Exploration Company. 173.

Egerton, Germeshausen & Grier, Inc. (EG&G). 119-121, 139, 140, 144, 146, 157, 172, 239-240, 251, 253.

USS Elder (AN-20). Operations: 50, 51, 62, 159, 160, 216, 226, 227, 236; Experimental Activities: 159, 222; MIKE Position: 183; Personnel Exposures: 217.

USS Estes (AGC-12). Operations: 50, 51, 56, 61, 67, 83, 105, 106, 179, 181, 187, 199, 201, 215, 223, 225, 235; Experimental Activities: 34, 140, 144, 152, 222; Personnel Exposures: 217; Position Data: 183, 201 (Figure 25).

Evans Signal Laboratory (ESL) (Army). 69, 73, 98, 119-121, 171, 210, 211.

Federal Civil Defense Agency (FCDA). 252.

Fleet Air Service Squadron-7 (FASRON-7) (Navy). 51, 232, 233.

Fleet Air Service Squadron-110 (FASRON-110) (Navy). 51, 216, 234.

USS Fletcher (DDE-445). Operations: 50, 51, 62, 153, 200, 216, 221-223; Experimental Activities: 34; Personnel Exposures: 218, Position Data: 183, 201 (Figure 25).

Holmes & Narver, Inc. (H&N). 32, 38, 40-42, 44, 45, 46, 56, 110, 179-181, 189, 194, 195, 201, 124, 138, 147, 168, 251, 253.

Headquarters USAF. 101, 165, 167, 184, 240.

Helicopter ASW Squadron 2 (HS-2) (Navy). Operations: 51, 62, 216, 232; Involvement with Radioactivity: 233; Personnel Exposures: 218.

Herrick L. Johnson, Inc. 119-121, 253.

Holter Research Foundation. 251, 253.

MV Horizon. Operations: 50, 51; Radsafe Activities: 22, 79; Experimental Activities: 158, 173, 182, 187, 192, 216, 222, 236; Involvement with Radioactivity: 229; Position Data: 183, 201 (Figure 25).

Joint Chiefs of Staff (JCS). 37.

Lackland AFB. 240.

LCU-666. 215, 218.

LCU-667. 215, 218.

LCU-709. 215, 218.

LCU-764. 215, 218.

LCU-851. 215.

USS Leo (AKA-60). Operations: 50, 51, 61, 153, 235, 224-226; Experimental Activities: 34, 178, 181, 201, 222; Position Data: 183.

USS Lipan (ATF-85). Operations: 50, 51, 61, 128, 173, 200, 215, 226-228, 235; Involvement with Radioactivity: 229; Personnel Exposures: 218.

Lookout Mountain Laboratory (Air Force). 56, 145, 150, 242.

USS LST-827. 70, 109; Operations: 50, 51, 61, 178, 201, 224-226; Position Data: 183, 201 (Figure 25).

Los Alamos Scientific Laboratory (LASL). Experimental Activities: 94, 118, 119-121, 132, 139-141, 144, 146-150, 155-158, 168, 170, 172, 173, 240, 250; Radsafe Procedures: 69, 83, 83, 91, 175; Sampling: 96, 101, 111; Personnel Exposures: 251.

USS Mansfield (DD-728). 221.

Marine Corps. 4, 248, 249, 258; see also entries under individual Marine Corps units.

Marine Corps Detachment USS Curtiss. 248.

Marine Corps Detachment USS Estes. 248.

Marine Corps Detachment, Naval Air Station, Kwajalein. 248.

Marine Corps Recruit Depot (Parris Island). 176, 239.

Glenn L. Martin Company. 164, 253.

Massachusetts Institute of Technology. 162.

Military Air Transport Service (MATS). 40, 55, 72, 181, 145, 246; see also individual MATS units.

USS Moctobi (ATF-105). 50.

Naval Administrative Unit, Sandia Base. 156, 175, 217, 219.

Naval Air Station, Norfolk. 175, 210, 219.

Naval Electronics Laboratory (NEL). 119-121, 160, 217, 219.

Naval Ordnance Laboratory (NOL). 119-121, 155, 164, 217, 220.

Naval Radiological Defense Laboratory (NRDL). 95, 152, 153, 160, 217, 220.

Naval Research Laboratory (NRL). 119-121, 134-136, 138, 139, 146, 159, 160, 168, 169, 239, 240.

Navy. 4, 214-237, 258; see also entries under individual Navy units.

Navy Special Weapons Unit. 217, 222.

Navy Hydrographic Office. 103, 173.

New York Operations Office (NYKOPO) (AEC). 72, 108.

USS Oak Hill (LSD-7). Operations: 50-51, 61, 163, 178, 181, 200, 215, 226-227, 235; Experimental Activities: 34, 153, 222; Involvement with Radioactivity: 198; Personnel Exposures: 218; Position Data: 183, 201 (Figure 25).

Oak Ridge National Laboratory (ORNL). 69, 176, 251, 252.

USS O'Bannon (DDE-450). Operations: 50, 51, 52, 62, 200-202, 204, 216, 221, 229-232, 236; Experimental Activities: 182, 190, 222; Involvement with Radioactivity: 197, 230, 153; Position Data: 183, 201 (Figure 25).

Office of Chief, Army Chemical Corps. 210, 211.

Office of Naval Research (ONR). 119-121, 158-160, 173, 217, 220.

Patrol Squadron 2 (VP-2) (Navy). 160, 216, 218, 234, 222, 236.

USS Radford (DDE-446). Operations: 50, 51, 62, 153, 216, 221, 223, 229, 232; Experimental Activities: 34, 153, 222; Position Data: 183, 201 (Figure 25); Involvement with Radioactivity: 198.

Rapid City AFB. 242.

USS Rendova (CVE-114). Operations: 50, 51, 83, 124, 125, 178, 180, 181, 188-190, 200, 216, 230-234, 236; Experimental activities: 34, 134, 140, 152, 153, 222; Radsafe Activities: 68, 71, 73, 91, 94, 109-111, 115; Involvement with Radioactivity: 194, 198, 206, 208; Personnel Exposures: 218.

Sandia Base. 147, 154, 156, 169, 175.

Sandia Corporation. 119-121, 134, 137, 155, 156, 157, 159, 160, 239, 240, 251, 252.

Scripps Institution of Oceanography (SIO). 50, 70, 119-121, 158, 159, 173.

Selfridge AFB. 240.

Seward AFB. 240.

Strategic Air Command (SAC) (Air Force). 240, 244.

Surgeon General (Air Force). 88.

USNS David C. Shanks (T-AP-180). Operations: 50, 51, 61, 179, 180, 215, 225, 235; Personnel Exposures: 217.

Signal Corps Engineering Laboratories (SCEL) (Army). 171.

USS Takelma (ATF-115) 50.

U.S. Coast Guard. 39, 40, 42, 47, 180, 252.

U.S. Coast and Geodetic Survey (USCGS). 173, 252.

USAF. 88, 101, 71.

U.S. Army Pacific (USARPAC). 78, 79, 213.

University of California, Los Angeles (UCLA). 251, 253.

University of California Radiation Laboratory (UCRL). 149, 150, 152, 251, 252.

University of Washington, Applied Fisheries Laboratory. 174, 251, 254.

Francis E. Warren AFB. 240.

Webb AFB. 240.

Wright Aeronautical Development Center (WADC) (Air Force). 119-121, 161, 162, 170, 172.

YON-69. 50, 236.

YON-146. 51, 236.

USS Yuma (ATF-94). Operations: 50, 51, 61, 159, 215, 226-228, 235; Experimental Activities: 222; Personnel Exposures: 218; Position Data: 183.

2nd Air Force. 162.

2nd Bombardment Wing (Air Force). 242.

2nd Marine Division. 176, 239.

3rd Marine Division. 176, 239.

4th Transportation Truck Company (Army). 47, 48, 210, 212.

6th Air Division. 145, 242.

6th Weather Group (Air Force). 241.

6th Weather Squadron (Air Force). 82.

7th Bombardment Wing (Air Force). 241.

8th Air Force. 162.

9th Weather Group. 241.

11th Air Rescue Squadron (Air Force). 82, 242.

11th Bombardment Wing (Air Force). 162, 241.

12th Air Division (Air Force). 240.

12th Fighter Escort Wing (Air Force). 241.

13th Naval District. 175, 220, 217.

18th Military Police, Criminal Investigation Division (Army). 47, 48, 180, 210, 212.

19th Air Division (Air Force). 241.

27th Fighter Wing (Air Force). 241.

31st Weather Squadron (Air Force). 39.

42nd Bombardment Squadron (Air Force). 241.

47th Air Transport Squadron (Air Force). 241, 246.

48th Air Transport Squadron (Air Force). 241, 246.

50th Air Transport Squadron (Air Force). 241, 246.

57th Strategic Reconnaissance Squadron (Air Force). 241.

57th Weather Reconnaissance Squadron (Air Force). 100, 104.

93rd Bombardment Wing (Air Force). 240.

125th Military Police, Provost Marshal Detachment (Army). 47, 48, 212.

306th Bombardment Wing (Air Force). 242.

307th Air Refueling Squadron (Air Force). 102, 241, 245.

338th Strategic Reconnaissance Wing (Air Force). 242.

435th Aircraft Installation Squadron (Air Force). 240.

435th Maintenance Squadron (Air Force). 175.

509th Bombardment Wing (Air Force). 241, 245.

511th Transportation Port Company (Army). Operations: 44, 45, 48, 74, 80, 21; Personnel Exposures: 210.

516th Military Police Service Company (Army). Operations: 47, 48, 56, 211; Personnel Exposures: 210.

523rd Motion Picture Squadron (Air Force). 242.

561st Fighter Escort Squadron (Air Force). 241.

971st OTSU, Army Chemical Corps. 171, 175, 210, 211.

1254th Air Transport Squadron (Air Force). 241, 246.

1352nd Motion Picture Squadron (Air Force). 176, 242; see also Lookout Mountain Laboratory.

1500th Air Transportation Group (Air Force). 39.

1500th Weather Reporting Squadron (Air Force). 242.

1502-1 Air Detachment (MATS). 181.

1810th Airways and Air Communications Service Squadron (Air Force). 242.

1960th Airways and Air Communications Service Squadron (Air Force). 39.

1960-1 Airways and Air Communications Service Detachment. 181.

2059th Air Weather Wing (Air Force). 103.

2060th Mobile Weather Squadron (Air Force). 103.

3160th Electronics Group (Air Force). 164, 241.

3398th Training Squadron (Air Force). 175, 240.

3536th OTS (Air Force). 242.

3882nd School Squadron (Air Force). 175, 240.

3902nd Air Base Wing (Air Force). 240, 244.

4908th Motor Vehicle Squadron (Air Force). 240.

4925th Atomic Test Group (Air Force). 138.

4925th Test Group Rad Section (Air Force). 81, 100.

4925th Test Squadron (Air Force). 240.

4930th Test Support Squadron (Air Force). 39, 240.

4931st Test Support Group (Air Force). 39, 44, 47.

6520th Flight Test Group (Air Force). 164, 241, 245.

7126th Army Unit. 39, 44, 45, 48, 56, 210, 212.

7131st Army Unit Signal Detachment. 45, 48, 180, 210, 213.

8452nd Administrative Area Unit (Army). 175, 210, 211.

8607th Administrative Area Unit (Communications Security Detachment) (Army). 47, 48, 211.

DISTRIBUTION LIST

DEPARTMENT OF DEFENSE

Armed Forces Staff College
ATTN: Library

Asst. Secy of Defense
Public Affairs
ATTN: PAO

Asst to the Secy of Defense
Atomic Energy
ATTN: Executive Asst
ATTN: Military Applications

Defense Nuclear Agency
ATTN: PAO
ATTN: GC
ATTN: BA
5 cy ATTN: NTPR
25 cy ATTN: TITL

Defense Tech Info Center
12 cy ATTN: DD

Field Command
Defense Nuclear Agency
ATTN: FCTT, W. Summa
ATTN: FCLS, J. Stinson
ATTN: FCTT, G. Ganong
ATTN: FCLS

Interservice Nuclear Weapons School
ATTN: TTV

National Defense University
ATTN: ICAF, Tech Library

DEPARTMENT OF THE ARMY

Army Library
ATTN: Military Documents Sect

Army Nuclear Test Personnel Review
2 cy ATTN: DAAG-AMR, R. Tago

U.S. Army Center of Military History
ATTN: DAMH-HSO

U.S. Army Chemical School
ATTN: ATZN-CM-AL
ATTN: ATZN-CM-CS

U.S. Army Comd & General Staff College
ATTN: Library

U.S. Army Nuclear & Chemical Agency
ATTN: Library

U.S. Army War College
ATTN: Library

U.S. Military Academy
ATTN: Director of Libraries

DEPARTMENT OF THE NAVY

Aviation History Unit
ATTN: Library

Bureau of Medicine and Surgery
ATTN: Asst. for Medical Surgery

James Carson Breckinridge Lib
ATTN: Library Div

Marine Corps Base
ATTN: Document Custodian

Marine Corps Dev & Education Command
ATTN: J. C. Breckinridge Lib

Marine Corps Historical Center
2 cy ATTN: Code HDH-2

Marine Corps Nuc Test Personnel Review
ATTN: Code MSRB-60

Merchant Marine Academy
ATTN: Director of Libraries

Naval Historical Center
ATTN: Operational Archives Branch

Naval Hospital Corps School
ATTN: Library

Naval Ocean Systems Center
ATTN: Library

Naval Oceanographic Office
ATTN: Code 025, Historian

Naval Postgraduate School
ATTN: Code 1424, Library

Naval Research Laboratory
ATTN: Library

Naval School
ATTN: Librarian

Naval Sea Systems Command
ATTN: Nuclear Technology Div

Naval Surface Weapons Center
ATTN: Library

Naval War College
ATTN: Professor 8 Libraries

Naval Weapons Center
ATTN: Code 233

Naval Weapons Evaluation Facility
ATTN: Library

DEPARTMENT OF THE NAVY (Continued)

Navy Department Library
ATTN: Librarian

Navy Nuclear Power School
ATTN: Library

Navy Nuclear Test Personnel Review
2 cy ATTN: W. Loeffler

Nimitz Library
ATTN: Documents & Reports Dept

Office of the Judge Adv Gen
ATTN: Code 73

U.S. Merchant Marine Academy
ATTN: Librarian

U.S. Naval Air Station Library
ATTN: Library

DEPARTMENT OF THE AIR FORCE

Aerospace Defense Command
ATTN: Historian

Air Force Communications Command
ATTN: Historian

Air Force Institute of Technology
ATTN: Library

Air Force Logistics Command
ATTN: Historian

Air Force Nuclear Test Personnel Review
ATTN: HQ USAF/SGES

Air Force Systems Command
ATTN: Historian

Air Force Technical Applications Ctr
ATTN: Historian

Air Force Weapons Laboratory
ATTN: Tech Library

Air National Guard
ATTN: Historian

Air Training Command
ATTN: Historian

Air University Library
ATTN: AUL-LSE

Military Airlift Command
ATTN: Historian

Pacific Air Forces
ATTN: Historian

Strategic Air Command
ATTN: Historian
ATTN: NRI-STINFO, Library

DEPARTMENT OF THE AIR FORCE (Continued)

Tactical Air Command
ATTN: Historian

U.S. Air Force Academy Library
ATTN: Library

U.S. Air Force Occupational & Env Health Lab
ATTN: NTPR

USAF School of Aerospace Medicine
ATTN: Strughold Library

DEPARTMENT OF ENERGY

Department of Energy
ATTN: OMA

Nevada Operations Office
ATTN: Health Physics Div
2 cy ATTN: R. Nutley

Human Health & Assessments Div
ATTN: Librarian

DEPARTMENT OF ENERGY CONTRACTORS

Holmes & Narver, Inc
ATTN: JNATDR

Lawrence Livermore National Lab
ATTN: Technical Info Dept Library

Los Alamos National Laboratory
ATTN: M. Walz, ADLA MS A183
ATTN: D. Cobb, ESS MSS D466
2 cy ATTN: Library
2 cy ATTN: ADPA MMS 195

Reynolds Electrical & Engr Co, Inc
ATTN: CIC
ATTN: W. Brady

Sandia National Lab
ATTN: Central Library
ATTN: W. Hereford

OTHER GOVERNMENT AGENCIES

U.S. Public Health Service
ATTN: G. Caldwell

Central Intelligence Agency
ATTN: Office of Medical Services

Dept of Health & Human Svcs
ATTN: Office of General Counsel

Exec Ofc of the President
Management & Budget Ofc Lib
ATTN: Librarian

Library of Congress
ATTN: Library Service Division
ATTN: Science & Technology Div
ATTN: Serial & Govt Publication

OTHER GOVERNMENT AGENCIES (Continued)

National Archives
ATTN: Librarian

National Atomic Museum
ATTN: Historian

Department of Commerce
ATTN: Librarian

Occupational Safety & Health Admin
ATTN: Library

Office of Health & Disability
ATTN: R. Copeland

Office of Workers Compensation Pgrm
ATTN: R. Larson

U.S. Coast Guard Academy Library
ATTN: Librarian

U.S. House of Representatives
2 cy ATTN: Committee on Armed Services

U.S. House of Representatives
ATTN: Subcommittee on Health & Envir

U.S. Senate
ATTN: Committee on Veterans Affairs

U.S. Senate
ATTN: Committee on Veterans Affairs

Veterans Administration - RO
Providence, RI
ATTN: Director

Veterans Administration
Washington, D.C.
ATTN: Board of Veteran Appeal

Veterans Administration - Ofc Central
Washington, D.C.
ATTN: Dept Veterans Benefit, Central Ofc
ATTN: Director

Veterans Administration - RO
Montgomery, AL
ATTN: Director

Veterans Administration - RO
Anchorage, AK
ATTN: Director

Veterans Administration - RO
Phoenix, AZ
ATTN: Director

Veterans Administration - RO
Little Rock, AR
ATTN: Director

Veterans Administration -RO
Los Angeles, CA
ATTN: Director

OTHER GOVERNMENT AGENCIES (Continued)

Veterans Administration - RO
San Francisco, CA
ATTN: Director

Veterans Administration - RO
Denver, CO
ATTN: Director

Veterans Administration - RO
Hartford, CT
ATTN: Director

Veterans Administration - RO
Wilmington, DE
ATTN: Director

Veterans Administration - RO
St. Petersburg, FL
ATTN: Director

Veterans Administration - RO
Atlanta, GA
ATTN: Director

Veterans Administration - RO
Honolulu, HI
ATTN: Director

Veterans Administration - RO
Chicago, IL
ATTN: Director

Veterans Administration - RO
Seattle, WA
ATTN: Director

Veterans Administration - RO
Indianapolis, IN
ATTN: Director

Veterans Administration - RO
Des Moines, IA
ATTN: Director

Veterans Administration - RO
Wichita, KS
ATTN: Director

Veterans Administration - RO
Louisville, KY
ATTN: Director

Veterans Administration - RO
New Orleans, LA
ATTN: Director

Veterans Administration - RO
Togus, ME
ATTN: Director

Veterans Administration - RO
Baltimore, MD
ATTN: Director

Veterans Administration - RO
Boston, MA
ATTN: Director

OTHER GOVERNMENT AGENCIES (Continued)

Veterans Administration - RO
St. Paul, MN
ATTN: Director

Veterans Administration - RO
Jackson, MS
ATTN: Director

Veterans Administration - RO
Huntington, WV
ATTN: Director

Veterans Administration - RO
St. Louis, MO
ATTN: Director

Veterans Administration - RO
Fort Harrison, MT
ATTN: Director

Veterans Administration - RO
Lincoln, NE
ATTN: Director

Veterans Administration - RO
Reno, NV
ATTN: Director

Veterans Administration - RO
Manchester, NH
ATTN: Director

Veterans Administration - RO
Newark, NJ
ATTN: Director

Veterans Administration - RO
Milwaukee, WI
ATTN: Director

Veterans Administration - RO
Albuquerque, NM
ATTN: Director

Veterans Administration - RO
Buffalo, NY
ATTN: Director

Veterans Administration -RO
New York, NY
ATTN: Director

Veterans Administration -RO
Winston Salem, NC
ATTN: Director

Veterans Administration - RO
Fargo, ND
ATTN: Director

Veterans Administration - RO
Cleveland, OH
ATTN: Director

Veterans Administration - RO
Muskogee, OK
ATTN: Director

OTHER GOVERNMENT AGENCIES (Continued)

Veterans Administration - RO
Portland, OR
ATTN: Director

Veterans Administration - RO
Pittsburgh, PA
ATTN: Director

Veterans Administration - RO
Philadelphia, PA
ATTN: Director

Veterans Administration - RO
APO San Francisco
ATTN: Director

Veterans Administration - RO
San Juan, Puerto Rico
ATTN: Director

Veterans Administration - RO
Columbia, SC
ATTN: Director

Veterans Administration - RO
Sioux Falls, SD
ATTN: Director

Veterans Administration - RO
Houston, TX
ATTN: Director

Veterans Administration - RO
Waco, TX
ATTN: Director

Veterans Administration - RO
Salt Lake City, UT
ATTN: Director

Veterans Administration - RO
White River Junction, VT
ATTN: Director

Veterans Administration - RO
Roanoke, VA
ATTN: Director

Veterans Administration - RO
Cheyenne, WY
ATTN: Director

Veterans Administration - RO
San Diego, CA
ATTN: Director

Veterans Administration - RO
Boise, ID
ATTN: Director

Veterans Administration - RO
Detroit, MI
ATTN: Director

OTHER GOVERNMENT AGENCIES (Continued)

Veterans administration - RO
Nashville, TN
ATTN: Director

The White House
ATTN: Domestic Policy Staff

DEPARTMENT OF DEFENSE CONTRACTORS

Advanced Research & Applications Corp
ATTN: H. Lee

JAYCOR
ATTN: A. Nelson
10 cy ATTN: Health & Environment Div

Kaman Tempo
ATTN: E. Martin
ATTN: DASIAAC

Kaman Tempo
ATTN: R. Miller

Kaman Tempo
ATTN: C. Jones

National Academy of Sciences
ATTN: C. Robinette
ATTN: Medical Follow-up Agency
ATTN: National Materials Advisory Board

Pacific-Sierra Research Corp
ATTN: H. Brode, Chairman SAGE

R & D Associates
ATTN: P. Haas

Science Applications, Inc
ATTN: Tech Library

Science Applications, Inc
10 cy ATTN: L. Novotney

OTHER

Adams State College
ATTN: Govt Publication Lib

Akron Public Library
ATTN: Govt Publication Librarian

Alabama St Dept of Archives & History
ATTN: Military Records Division

University of Alabama
ATTN: Reference Dept/Documents

University of Alaska
ATTN: Director of Libraries

University of Alaska
ATTN: Govt Publication Librarian

OTHER (Continued)

Albany Public Library
ATTN: Librarian

Alexander City State Jr College
ATTN: Librarian

Allegheny College
ATTN: Librarian

Allen County Public Library
ATTN: Librarian

Altoona Area Public Library
ATTN: Librarian

American Statistics Index
ATTN: Cathy Jarvey

Anaheim Public Library
ATTN: Librarian

Andrews Library, College of Wooster
ATTN: Government Documents

Angelo State University Library
ATTN: Librarian

Angelo Iacoboni Pub Lib
ATTN: Librarian

Anoka County Library
ATTN: Librarian

Appalachian State University
ATTN: Library Documents

Arizona State University Library
ATTN: Librarian

University of Arizona
ATTN: Gov Doc Dept, C. Bower

Arkansas College Library
ATTN: Library

Arkansas Library Comm
ATTN: Library

Arkansas State University
ATTN: Library

University of Arkansas
ATTN: Government Documents Div

Austin College
Arthur Hopkins Library
ATTN: Librarian

Atlanta Public Library
ATTN: Ivan Allen Dept

Atlanta University Center
ATTN: Librarian

OTHER (Continued)

Auburn Univ at Montgomery Lib
ATTN: Librarian

B. Davis Schwartz Mem Lib
ATTN: Librarian

Bangor Public Library
ATTN: Librarian

Bates College Library
ATTN: Librarian

Baylor University Library
ATTN: Docs Dept

Beloit College Libraries
ATTN: Serials Docs Dept

Bemidji State College
ATTN: Library

Benjamin F. Feinberg Library
State University College
ATTN: Government Documents

Bierce Library, Akron University
ATTN: Government Documents

Boston Public Library
ATTN: Documents Department

Bowdoin College
ATTN: Librarian

Bowling Green State Univ
ATTN: Govt Docs Services

Bradley University
ATTN: Govt Publication Librarian

Brandeis University Lib
ATTN: Documents Section

Brigham Young University
ATTN: Librarian

Brigham Young University
ATTN: Documents Collection

Brookhaven National Laboratory
ATTN: Technical Library

Brooklyn College
ATTN: Documents Division

Broward County Library Sys
ATTN: Librarian

Brown University
ATTN: Librarian

Bucknell University
ATTN: Reference Dept

OTHER (Continued)

Buffalo & Erie Co Pub Lib
ATTN: Librarian

Burlington Library
ATTN: Librarian

California at Fresno State Univ Lib
ATTN: Library

California at San Diego University
ATTN: Documents Department

California at Stanislaus St Clg Lib
ATTN: Library

California St Polytechnic Univ Lib
ATTN: Librarian

California St Univ at Northridge
ATTN: Gov Doc

California State Library
ATTN: Librarian

California State Univ at Long Beach Lib
ATTN: Librarian

California State University
ATTN: Librarian

California State University
ATTN: Librarian

California Univ Library
ATTN: Govt Publications Dept

California Univ Library
ATTN: Librarian

California University Library
ATTN: Govt Documents Dept

California University Library
ATTN: Documents Sec

California University
ATTN: Government Documents Dept

Calvin College Library
ATTN: Librarian

Calvin T. Ryan Library
Kearney State College
ATTN: Govt Documents Dept

Carleton College Library
ATTN: Librarian

Carnegie Library of Pittsburgh
ATTN: Librarian

Carnegie Mellon University
ATTN: Director of Libraries

OTHER (Continued)

Carson Regional Library
ATTN: Gov Publications Unit

Case Western Reserve University
ATTN: Librarian

University of Central Florida
ATTN: Library Docs Dept

Central Michigan University
ATTN: Library Documents Section

Central Missouri State Univ
ATTN: Government Documents

Central State University
ATTN: Library Documents Dept

Central Washington University
ATTN: Library Docs Section

Central Wyoming College Library
ATTN: Librarian

Charleston County Library
ATTN: Librarian

Charlotte & Mecklenburg County Pub Lib
ATTN: E. Correll

Chattanooga Hamilton Co
ATTN: Librarian

Chesapeake Pub Lib System
ATTN: Librarian

Chicago Public Library
ATTN: Governments Publications Dept

State University of Chicago
ATTN: Librarian

Chicago University Library
ATTN: Director of Libraries
ATTN: Documents Processing

Cincinnati University Library
ATTN: Librarian

Claremont Colleges Libs
ATTN: Doc Collection

Clemson University
ATTN: Director of Libraries

Cleveland Public Library
ATTN: Documents Collection

Cleveland State Univ Lib
ATTN: Librarian

Coe Library
ATTN: Documents Division

OTHER (Continued)

Colgate Univ Library
ATTN: Reference Library

Colorado State Univ Libs
ATTN: Librarian

Colorado University Libraries
ATTN: Director of Libraries

Columbia University Library
ATTN: Documents Service Center

Columbus & Franklin Cty Public Lib
ATTN: Gen Rec Div

Compton Library
ATTN: Librarian

Connecticut State Library
ATTN: Librarian

University of Connecticut
ATTN: Govt of Connecticut

Connecticut University
ATTN: Director of Libraries

Cornell University Lib
ATTN: Librarian

Corpus Christi State University Lib
ATTN: Librarian

Culver City Library
ATTN: Librarian

Curry College Library
ATTN: Librarian

Dallas County Public Library
ATTN: Librarian

Dallas Public Library
ATTN: Librarian

Dalton Jr College Library
ATTN: Librarian

Dartmouth College
ATTN: Librarian

Davenport Public Library
ATTN: Librarian

Davidson College
ATTN: Librarian

Dayton & Montgomery City Pub Lib
ATTN: Librarian

University of Dayton
ATTN: Librarian

OTHER (Continued)

Decatur Public Library
ATTN: Librarian

Dekalb Comm Coll So Cpus
ATTN: Librarian

Delaware Pauw University
ATTN: Librarian

University of Delaware
ATTN: Librarian

Delta College Library
ATTN: Librarian

Delta State University
ATTN: Librarian

Denison Univ Library
ATTN: Librarian

Denver Public Library
ATTN: Documents Div

Dept of Lib & Archives
ATTN: Librarian

Detroit Public Library
ATTN: Librarian

Dickinson State College
ATTN: Librarian

Drake Memorial Learning Resource Ctr
ATTN: Librarian

Drake University
ATTN: Cowles Library

Drew University
ATTN: Librarian

Duke University
ATTN: Public Docs Dept

Duluth Public Library
ATTN: Documents Section

Earlham College
ATTN: Librarian

East Carolina University
ATTN: Library Docs Dept

East Central University
ATTN: Librarian

East Islip Public Library
ATTN: Librarian

East Orange Public Lib
ATTN: Librarian

East Tennessee State Univ Sherrod Lib
ATTN: Documents Dept

OTHER (Continued)

East Texas State University
ATTN: Library

Eastern Branch
ATTN: Librarian

Eastern Illinois University
ATTN: Librarian

Eastern Kentucky University
ATTN: Librarian

Eastern Michigan University Lib
ATTN: Documents Libn

Eastern Montana College Library
ATTN: Documents Dept

Eastern New Mexico Univ
ATTN: Librarian

Eastern Oregon College Library
ATTN: Librarian

Eastern Washington Univ
ATTN: Librarian

El Paso Public Library
ATTN: Documents & Geneology Dept

Elko County Library
ATTN: Librarian

Elmira College
ATTN: Librarian

Elon College Library
ATTN: Librarian

Enoch Pratt Free Library
ATTN: Documents Office

Emory University
ATTN: Librarian

Evansville & Vanderburgh County Pub Lib
ATTN: Librarian

Everett Public Library
ATTN: Librarian

Fairleigh Dickinson Univ
ATTN: Depository Dept

Florida A & M Univ
ATTN: Librarian

Florida Atlantic Univ Lib
ATTN: Div of Public Documents

Florida Institute of Tech Lib
ATTN: Federal Documents Dept

Florida Intl Univ Library
ATTN: Docs Section

OTHER (Continued)

Florida State Library
ATTN: Documents Section

Florida State University
ATTN: Librarian

Florida University Libraries
ATTN: Documents Dept

Fond Du Lac Public Lib
ATTN: Librarian

Fort Hays State University
ATTN: Librarian

Fort Worth Public Library
ATTN: Librarian

Free Pub Lib of Elizabeth
ATTN: Librarian

Free Public Library
ATTN: Librarian

Freeport Public Library
ATTN: Librarian

Fresno County Free Library
ATTN: Librarian

Gadsden Public Library
ATTN: Librarian

Garden Public Library
ATTN: Librarian

Gardner Webb College
ATTN: Documents Librn

Gary Public Library
ATTN: Librarian

Georgetown Univ Library
ATTN: Govt Docs Room

Georgia Inst of Tech
ATTN: Librarian

Georgia Southern College
ATTN: Librarian

Georgia Southwestern College
ATTN: Director of Libraries

Georgia State Univ Lib
ATTN: Librarian

University of Georgia
ATTN: Dir of Libraries

Glassboro State College
ATTN: Librarian

Gleeson Library
ATTN: Librarian

OTHER (Continued)

Government Publications Library-M
ATTN: Director of Libraries

Graceland College
ATTN: Librarian

Grand Forks Public City-County Library
ATTN: Librarian

Grand Rapids Public Library
ATTN: Director of Libraries

Greenville County Library
ATTN: Librarian

Guam RFK Memorial University Lib
ATTN: Fed Depository Collection

University of Guam
ATTN: Librarian

Gustavus Adolphus College
ATTN: Library

Hardin-Simmons University Library
ATTN: Librarian

Hartford Public Library
ATTN: Librarian

Harvard College Library
ATTN: Director of Libraries

Harvard College Library
ATTN: Librarian

University of Hawaii
ATTN: Government Docs Collection

Hawaii State Library
ATTN: Federal Documents Unit

University of Hawaii at Monoa
ATTN: Director of Libraries

University of Hawaii
ATTN: Librarian

Haydon Burns Library
ATTN: Librarian

Henry Ford Comm College Lib
ATTN: Librarian

Herbert H. Lehman College
ATTN: Library Documents Division

Hofstra Univ Library
ATTN: Documents Dept

Hollins College
ATTN: Librarian

Hoover Institution
ATTN: J. Bingham

OTHER (Continued)

Hopkinsville Comm College
ATTN: Librarian

University of Houston, Library
ATTN: Documents Div

Houston Public Library
ATTN: Librarian

Hoyt Public Library
ATTN: Librarian

Humboldt State College Library
ATTN: Documents Dept

Huntington Park Library
ATTN: Librarian

Hutchinson Public Library
ATTN: Librarian

Idaho Public Lib & Info Center
ATTN: Librarian

Idaho State Library
ATTN: Librarian

Idaho State University Library
ATTN: Documents Dept

University of Idaho
ATTN: Documents Sect
ATTN: Dir of Libraries

University of Illinois, Library
ATTN: Documents Section

Illinois State Library
ATTN: Government Documents Branch

Illinois Univ at Urbana Champaign
ATTN: P. Watson, Documents Library

Illinois Valley Comm Coll
ATTN: Library

Indiana State Library
ATTN: Serial Section

Indiana State University
ATTN: Documents Libraries

Indiana University Library
ATTN: Documents Department

Indianapolis Marion Cty Pub Library
ATTN: Social Science Div

Iowa State University Library
ATTN: Govt Documents Dept

Iowa University Library
ATTN: Government Documents Dept

OTHER (Continued)

Butler University, Irwin Library
ATTN: Librarian

Isaac Delchdo College
ATTN: Librarian

James Madison University
ATTN: Librarian

Jefferson County Public Lib
ATTN: Librarian

Jersey City State College
ATTN: Librarian

Johns Hopkins University
ATTN: Documents Library

John J. Wright Library, La Roche College
ATTN: Librarian

Johnson Free Public Lib
ATTN: Librarian

Kahului Library
ATTN: Librarian

Kalamazoo Public Library
ATTN: Librarian

Kansas City Public Library
ATTN: Documents Div

Kansas State Library
ATTN: Librarian

Kansas State Univ Library
ATTN: Documents Dept

University of Kansas
ATTN: Director of Libraries

Kent State University Library
ATTN: Documents Div

Kentucky Dept of Library & Archives
ATTN: Documents Section

University of Kentucky
ATTN: Governments Publication Dept
ATTN: Director of Libraries

Kenyon College Library
ATTN: Librarian

Lake Forest College
ATTN: Librarian

Lake Sumter Comm Coll Lib
ATTN: Librarian

Lakeland Public Library
ATTN: Librarian

OTHER (Continued)

Lancaster Regional Library
ATTN: Librarian

Lawrence University
ATTN: Documents Dept

Lee Library, Brigham Young University
ATTN: Documents & Map Section

Library & Statutory Distribution & Svc
2 cy ATTN: Librarian

Little Rock Public Library
ATTN: Librarian

Long Beach Publ Library
ATTN: Librarian

Los Angeles Public Library
ATTN: Serials Div U.S. Documents

Louisiana State University
ATTN: Government Doc Dept
ATTN: Director of Libraries

Louisville Free Pub Lib
ATTN: Librarian

Louisville Univ Library
ATTN: Librarian

Lyndon B. Johnson Sch of Pub Affairs Lib
ATTN: Librarian

Maine Maritime Academy
ATTN: Librarian

Maine University at Oreno
ATTN: Librarian

University of Maine
ATTN: Librarian

Manchester City Library
ATTN: Librarian

Mankato State College
ATTN: Govt Publications

Mantor Library
Univ of Maine at Farmington
ATTN: Director of Libraries

Marathon County Public Library
ATTN: Librarian

Marshall Brooks Library
ATTN: Librarian

University of Maryland
ATTN: McKeldin Libr Docs Div

University of Maryland
ATTN: Librarian

OTHER (Continued)

University of Massachusetts
ATTN: Government Docs College

McNeese State Univ
ATTN: Librarian

Memphis Shelby County Pub Lib & Info Ctr
ATTN: Librarian

Memphis State University
ATTN: Librarian

Mercer University
ATTN: Librarian

Mesa County Public Library
ATTN: Librarian

University of Miami, Library
ATTN: Government Publications

Miami Public Library
ATTN: Documents Division

Miami Univ Library
ATTN: Documents Dept

Michel Orradre Library
University of Santa Clara
ATTN: Documents Div

Michigan State Library
ATTN: Librarian

Michigan State University Library
ATTN: Librarian

Michigan Tech University
ATTN: Library Documents Dept

University of Michigan
ATTN: Acq Sec Documents Unit

Middlebury College Library
ATTN: Librarian

Millersville State Coll
ATTN: Librarian

Milne Library
State University of New York
ATTN: Docs Librn

Milwaukee Pub Lib
ATTN: Librarian

Minneapolis Public Lib
ATTN: Librarian

Minnesota Div of Emergency Svcs
ATTN: Librarian

Minot State College
ATTN: Librarian

Mississippi State University
ATTN: Librarian

OTHER (Continued)

University of Mississippi
ATTN: Director of Libraries

Missouri Univ at Kansas City Gen
ATTN: Librarian

Missouri University Library
ATTN: Government Documents

M.I.T. Libraries
ATTN: Librarian

Mobile Public Library
ATTN: Governmental Info Division

Moffett Library
ATTN: Librarian

Montana State Library
ATTN: Librarian

Montana State University, Library
ATTN: Librarian

University of Montana
ATTN: Documents Div

Moorhead State College
ATTN: Library

Mt Prospect Public Lib
ATTN: Librarian

Murray State Univ Lib
ATTN: Library

Nassau Library System
ATTN: Librarian

Natrona County Public Library
ATTN: Librarian

Nebraska Library Comm
ATTN: Librarian

Univ of Nebraska at Omaha
ATTN: Librarian

Nebraska Western College Library
ATTN: Librarian

Univ of Nebraska at Lincoln
ATTN: Director of Libraries

Univ of Nevada at Reno
ATTN: Governments Pub Dept

Univ of Nevada at Las Vegas
ATTN: Director of Libraries

New Hampshire University Lib
ATTN: Librarian

New Hanover County Public Library
ATTN: Librarian

Nebraska University
ATTN: Director of Libraries

OTHER (Continued)

New Mexico State Library
ATTN: Librarian

New Mexico State University
ATTN: Lib Documents Div

University of New Mexico
ATTN: Director of Libraries

University of New Orleans Library
ATTN: Govt Documents Div

New Orleans Public Lib
ATTN: Library

New York Public Library
ATTN: Librarian

New York State Library
ATTN: Doc Control, Cultural Ed Ctr

New York State Univ at Stony Brook
ATTN: Main Lib Doc Sect

New York State Univ Col at Cortland
ATTN: Librarian

State Univ of New York
ATTN: Library Documents Sec

State Univ of New York
ATTN: Librarian

New York State University
ATTN: Documents Center

State University of New York
ATTN: Documents Dept

New York University Library
ATTN: Documents Dept

Newark Free Library
ATTN: Librarian

Newark Public Library
ATTN: Librarian

Niagara Falls Pub Lib
ATTN: Librarian

Nicholls State Univ Library
ATTN: Docs Div

Nieves M. Flores Memorial Lib
ATTN: Librarian

Norfolk Public Library
ATTN: R. Parker

North Carolina Agri & Tech State Univ
ATTN: Librarian

Univ of North Carolina at Charlotte
ATTN: Atkins Library Documents Dept

Univ of North Carolina at Greensboro, Library
ATTN: Librarian

OTHER (Continued)

North Carolina Central University
ATTN: Librarian

North Carolina State University
ATTN: Librarian

North Carolina University at Wilmington
ATTN: Librarian

University of North Carolina
ATTN: BA SS Division Documents

North Dakota State University Lib
ATTN: Docs Librarian

University of North Dakota
ATTN: Librarian

North Georgia College
ATTN: Librarian

North Texas State University Library
ATTN: Librarian

Northeast Missouri State University
ATTN: Librarian

Northeastern Illinois University
ATTN: Library

Northeastern Oklahoma State Univ
ATTN: Librarian

Northeastern University
ATTN: Dodge Library

Northern Arizona University Lib
ATTN: Government Documents Dept

Northern Illinois University
ATTN: Librarian

Northern Iowa University
ATTN: Library

Northern Michigan Univ
ATTN: Documents

Northern Montana College Library
ATTN: Librarian

Northwestern Michigan College
ATTN: Librarian

Northwestern State Univ
ATTN: Librarian

Northwestern State Univ Library
ATTN: Librarian

Northwestern University Library
ATTN: Govt Publications Dept

Norwalk Public Library
ATTN: Librarian

OTHER (Continued)

University of Notre Dame
ATTN: Document Center

Oakland Comm College
ATTN: Librarian

Oakland Public Library
ATTN: Librarian

Oberlin College Library
ATTN: Librarian

Ocean County College
ATTN: Librarian

Ohio State Library
ATTN: Librarian

Ohio State University
ATTN: Libraries Documents Division

Ohio University Library
ATTN: Docs Dept

Oklahoma City University Library
ATTN: Librarian

Oklahoma City University Library
ATTN: Librarian

Oklahoma Dept of Libraries
ATTN: U.S. Govt Documents

University of Oklahoma
ATTN: Documents Div

Old Dominion University
ATTN: Doc Dept Univ Library

Olivet College Library
ATTN: Librarian

Omaha Pub Lib Clark Branch
ATTN: Librarian

Oregon State Library
ATTN: Librarian

University of Oregon
ATTN: Documents Section

Ouachita Baptist University
ATTN: Librarian

Pan American University Library
ATTN: Librarian

Passaic Public Library
ATTN: Librarian

Paul Klapper Library
ATTN: Documents Dept

Pennsylvania State Library
ATTN: Government Publications Section

OTHER (Continued)

Pennsylvania State University
ATTN: Library Document Sec

University of Pennsylvania
ATTN: Director of Libraries

Penrose Library
University of Denver
ATTN: Penrose Library

Peoria Public Library
ATTN: Business, Science & Tech Dept

Free Library of Philadelphia
ATTN: Govt Publications Dept

Philipsburg Free Public Library
ATTN: Library

Phoenix Public Library
ATTN: Librarian

University of Pittsburg
ATTN: Documents Office G 8

Plainfield Public Library
ATTN: Librarian

Popular Creek Public Lib District
ATTN: Librarian

Association of Portland Lib
ATTN: Librarian

Portland Public Library
ATTN: Librarian

Portland State University Library
ATTN: Librarian

Prescott Memorial Lib
Louisiana Tech Univ
ATTN: Librarian

Princeton University Library
ATTN: Documents Division

Providence College
ATTN: Librarian

Providence Public Library
ATTN: Librarian

Cincinnati & Hamilton County Public Library
ATTN: Librarian

Public Library of Nashville and Davidson County
ATTN: Library

University of Puerto Rico
ATTN: Doc & Maps Room

Purdue University Library
ATTN: Librarian

OTHER (Continued)

Quinebaug Valley Community Col
ATTN: Librarian

Ralph Brown Draughon Lib
Auburn University
ATTN: Microforms & Documents Dept

Rapid City Public Library
ATTN: Librarian

Reading Public Library
ATTN: Librarian

Reed College Library
ATTN: Librarian

Reese Library
Augusta College
ATTN: Librarian

University of Rhode Island Library
ATTN: Govt Publications Office

University of Rhode Island
ATTN: Director of Libraries

Rice University
ATTN: Director of Libraries

Richard W. Norton Mem Lib
Louisiana College
ATTN: Librarian

Richland County Pub Lib
ATTN: Librarian

University of Richmond
ATTN: Library

Riverside Public Library
ATTN: Librarian

University of Rochester Library
ATTN: Documents Section

Rutgers University, Camden Library
ATTN: Librarian

Rutgers State University
ATTN: Librarian

Rutgers University
ATTN: Director of Libraries

Rutgers University Law Library
ATTN: Federal Documents Dept

Salem College Library
ATTN: Librarian

Samford University
ATTN: Librarian

San Antonio Public Library
ATTN: Bus Science & Tech Dept

OTHER (Continued)

San Diego County Library
ATTN: C. Jones, Acquisitions

San Diego Public Library
ATTN: Librarian

San Diego State University Library
ATTN: Govt Pubs Dept

San Francisco Public Library
ATTN: Govt Documents Dept

San Francisco State College
ATTN: Govt Pub Collection

San Jose State College Library
ATTN: Documents Dept

San Luis Obispo City-County Library
ATTN: Librarian

Savannah Pub & Effingham Libty Reg Lib
ATTN: Librarian

Scottsbluff Public Library
ATTN: Librarian

Scranton Public Library
ATTN: Librarian

Seattle Public Library
ATTN: Ref Doc Asst

Selby Public Library
ATTN: Librarian

Shawnee Library System
ATTN: Librarian

Shreve Memorial Library
ATTN: Librarian

Silas Bronson Public Library
ATTN: Librarian

Simon Schwob Mem Lib
Columbus College
ATTN: Librarian

Sioux City Public Library
ATTN: Librarian

Skidmore College
ATTN: Librarian

Slippery Rock State College Library
ATTN: Librarian

South Carolina State Library
ATTN: Librarian

University of South Carolina
ATTN: Librarian

OTHER (Continued)

University of South Carolina
ATTN: Government Documents

South Dakota Sch of Mines & Tech
ATTN: Librarian

South Dakota State Library
ATTN: Federal Documents Department

University of South Dakota
ATTN: Documents Librarian

South Florida University Library
ATTN: Librarian

Southdale-Hennepin Area Library
ATTN: Government Documents

Southeast Missouri State University
ATTN: Librarian

Southeastern Massachusetts University Library
ATTN: Documents Sec

University of Southern Alabama
ATTN: Librarian

Southern California University Library
ATTN: Documents Dept

Southern Connecticut State College
ATTN: Library

Southern Illinois University
ATTN: Librarian

Southern Illinois University
ATTN: Documents Ctr

Southern Methodist University
ATTN: Librarian

University of Southern Mississippi
ATTN: Library

Southern Oregon College
ATTN: Library

Southern University in New Orleans, Library
ATTN: Librarian

Southern Utah State College Library
ATTN: Documents Department

Southwest Missouri State College
ATTN: Library

Southwestern University of Louisiana, Libraries
ATTN: Librarian

Southwestern University School of Law Library
ATTN: Librarian

OTHER (Continued)

Spokane Public Library
ATTN: Reference Dept

Springfield City Library
ATTN: Documents Section

St. Bonaventure University
ATTN: Librarian

St. Joseph Public Library
ATTN: Librarian

St. Lawrence University
ATTN: Librarian

St. Louis Public Library
ATTN: Librarian

St. Paul Public Library
ATTN: Librarian

Stanford University Library
ATTN: Govt Documents Dept

State Historical Soc Lib
ATTN: Docs Serials Section

State Library of Massachusetts
ATTN: Librarian

State University of New York
ATTN: Librarian

Stetson Univ
ATTN: Librarian

University of Steubenville
ATTN: Librarian

Stockton & San Joaquin Public Lib
ATTN: Librarian

Stockton State College Library
ATTN: Librarian

Superior Public Library
ATTN: Librarian

Swarthmore College Lib
ATTN: Reference Dept

Syracuse University Library
ATTN: Documents Div

Tacoma Public Library
ATTN: Librarian

Tampa, Hillsborough County Public Lib
ATTN: Librarian

Temple University
ATTN: Librarian

Tennessee Technological University
ATTN: Librarian

OTHER (Continued)

University of Tennessee
ATTN: Dir of Libraries

Terteling Library
College of Idaho
ATTN: Librarian

Texas A & M University Library
ATTN: Librarian

University of Texas at Arlington
ATTN: Library Documents

University of Texas at San Antonio
ATTN: Library

Texas Christian University
ATTN: Librarian

Texas State Library
ATTN: U.S. Documents Sect

Texas Tech University Library
ATTN: Govt Docs Dept

Texas University at Austin
ATTN: Documents Coll

Texas University at El Paso
ATTN: Documents and Maps Lib

University of Toledo Library
ATTN: Librarian

Toledo Public Library
ATTN: Social Science Dept

Torrance Civic Center Library
ATTN: Librarian

Traverse City Public Library
ATTN: Librarian

Trenton Free Public Library
ATTN: Librarian

Trinity College Library
ATTN: Librarian

Trinity University Library
ATTN: Documents Collection

Tufts University Library
ATTN: Documents Dept

Tulane University
ATTN: Documents Dept

University of Tulsa
ATTN: Librarian

UCLA Research Library
ATTN: Public Affairs Svc/US Docs

OTHER (Continued)

Uniformed Svcs Univ of the Hlth Sci
ATTN: LRC Library

University Libraries
ATTN: Dir of Libraries

Upper Iowa College
ATTN: Documents Collection

Utah State University
ATTN: Librarian

University of Utah
ATTN: Special Collections

University of Utah
ATTN: Dept of Pharmacology
ATTN: Director of Libraries

Valencia Library
ATTN: Librarian

Vanderbilt University Library
ATTN: Govt Docs Sect

University of Vermont
ATTN: Director of Libraries

Virginia Commonwealth University
ATTN: Librarian

Virginia Military Institute
ATTN: Librarian

Virginia Polytechnic Inst Lib
ATTN: Docs Dept

Virginia State Library
ATTN: Serials Section

University of Virginia
ATTN: Public Documents

Volusia County Public Libraries
ATTN: Librarian

Washington State Library
ATTN: Documents Section

Washington State University
ATTN: Lib Documents Section

Washington University Libraries
ATTN: Dir of Libraries

University of Washington
ATTN: Documents Div

Wayne State University Library
ATTN: Librarian

Wayne State University Law Library
ATTN: Documents Dept

Weber State College Library
ATTN: Librarian

Wagner College
ATTN: Librarian

OTHER (Continued)

Wesleyan University
ATTN: Documents Librarian

West Chester State Coll
ATTN: Documents Dept

West Covina Library
ATTN: Librarian

University of West Florida
ATTN: Librarian

West Hills Community Coll
ATTN: Library

West Texas State University
ATTN: Library

West Virginia Coll of Grad Studies Lib
ATTN: Librarian

University of West Virginia
ATTN: Dir of Libraries

Westerly Public Library
ATTN: Librarian

Western Carolina University
ATTN: Librarian

Western Illinois University Lib
ATTN: Librarian

Western Washington Univ
ATTN: Librarian

Western Wyoming Community College Lib
ATTN: Librarian

Westmoreland Cty Comm Coll
ATTN: Learning Resource Ctr

Whitman College
ATTN: Librarian

Wichita State Univ Library
ATTN: Librarian

William & Mary College
ATTN: Docs Dept

William Allen White Library
Emporia Kansas State College
ATTN: Govt Documents Div

William College Library
ATTN: Librarian

Willimantic Public Library
ATTN: Librarian

Winthrop College
ATTN: Documents Dept

University of Wisconsin at Whitewater
ATTN: Governments Documents Library

OTHER (Continued)

Wisconsin Milwaukee University
ATTN: Librarian

Wisconsin Oshkosh University
ATTN: Librarian

Wisconsin Platteville University
ATTN: Librarian

Wisconsin University at Stevens Point
ATTN: Docs Section

University of Wisconsin
ATTN: Govt Pubs Dept

University of Wisconsin
ATTN: Acquisitions Dept

Worcester Public Library
ATTN: Librarian

OTHER (Continued)

Yale University
ATTN: Director of Libraries

Yeshiva University
ATTN: Librarian

Yuma City County Library
ATTN: Librarian

Wright State Univ Library
ATTN: Govts Documents Dept

Wyoming State Library
ATTN: Librarian

University of Wyoming
ATTN: Documents Div

